

# Mathematics Behind Planimeters

by

Osman Yardimci

A thesis submitted to the Graduate Faculty of  
Auburn University  
in partial fulfillment of the  
requirements for the Degree of  
Master of Science

Auburn, Alabama  
Aug 3, 2013

Keywords: Planimeter, Green theorem, Guldin-Pappus theorem

Approved by

Andras Bezdek, Chair, C. Harry Knowles Professor of Mathematics  
Narendra Kumar Govil, Alumni Professor of Mathematics and Statistics  
Wlodzimierz Kuperberg, Professor of Mathematics and Statistics

## Abstract

**Original master thesis project:** By studying the literature, collect and write a survey paper on the mathematics of the planimeters. Planimeter is a somewhat forgotten ingenious device which was invented in 1814 to satisfy the area computational need of land surveyors and other real life applications. The project also asked for filling in details of published proofs and asked for including, if possible, some new statements and generalizations.

**On the importance of planimeters:** The history of approximating and computing areas goes back to 3000 BC, when the ancient Egyptians approximated the area of circles. A great deal of knowledge on areas was summarized by Euclid around 300 BC in his book entitled Elements. Undoubtedly the discovery of modern time calculus by Newton and Leibnitz around 1660 was the biggest advancement in area computation. At the beginning of the 18th century, practical mechanical tools, called planimeters, were patented for determining the area closed regions.

**The following are the outcomes of the thesis:** 8 papers ([1], [2], [3], [4], [5], [6], [7], [8]) were included in this review. The mathematics of both of the linear and the polar planimeters were studied. All arguments were based on Green's theorem, on the Area Difference Theorem, and on the theorems concerning sweeping line segments. These theorems are explained in the first half of the thesis. It turned out that there are two basic approaches at proving the correctness of planimeters. The section which explains the indirect approach (using Green's theorem without computing the involved integrals) is based on a work of B. Casselman [4]. The section which explains the direct approach (using Green's theorem with computing the involved integrals) is based on the work of Ronald W. Gatterdam, [1]. The explicit approach in the paper of Gatterdam was explained when the two arms of the polar

planimeter had equal length. Using the method of Gatterdam, I verified the correctness of the polar planimeter in case the arms had different lengths.

## Acknowledgments

I would like to acknowledge my advisor Andras Bezdek for his tireless support. I also would like thank professors, Narendra Kumar Govil and Wlodzimierz Kuperberg for their willingness to serve on my master committee.

Without the generous financial support of the republic of Turkey government and especially that of the current prime minister, Recep Tayyip Erdoğan, I would not be able to attend the mathematics program at Auburn University.

Special thanks go for my friend Olcay Ciftci and his family. They always encouraged me and were willing to help me at various stages of my career.

The last but the greatest thank goes to my parents, Reşat and Rahime Yardimci and to my wife, Gönül, and to my siblings, Ayşe, Fatma and Cevat. Throughout all my life I enjoyed their continuous and loving supports.

## Table of Contents

Abstract . . . . .	ii
Acknowledgments . . . . .	iv
List of Figures . . . . .	vi
1 Introduction . . . . .	1
2 Two Area Formulas for Polygons . . . . .	4
3 Planimeters . . . . .	8
3.1 Discription of the Linear Planimeter . . . . .	8
3.2 Description of the Polar Planimeter . . . . .	10
3.3 Total Rolling of the Planimeters Measuring Wheel and the Swept Area . . . . .	13
4 Explaining Planimeters by Green's Theorem Without Evaluating Integrals . . . . .	25
4.1 Green's Theorem . . . . .	25
4.2 An Application of Green's Theorem for the Polar Planimeter . . . . .	27
4.3 An Application of Green's Theorem to the Linear Planimter . . . . .	33
5 Explaining Planimeters by Green's Theorem With Evaluating Integrals . . . . .	38
5.1 The Direct Use of Green's Theorem for the Polar Planimeter . . . . .	38
5.2 The Direct Use of Green's Theorem for the Linear Planimeter . . . . .	43
Bibliography . . . . .	46

## List of Figures

2.1	<i>A three angle . . . . .</i>	5
2.2	<i>A simple octagon . . . . .</i>	6
3.1	<i>Technical drawing of the linear planimeter . . . . .</i>	9
3.2	<i>The reachable region of the linear planimeter and <math>-90^\circ &lt; \theta^\circ &lt; 90^\circ</math> . . . . .</i>	9
3.3	<i>Technical drawing of the polar planimeter . . . . .</i>	10
3.4	<i>The polar planimeter . . . . .</i>	10
3.5	<i>Traceable annulus area . . . . .</i>	11
3.6	<i>To uniquely determine the position of the tracer on the curve, the angle between the polar and the tracer arm must be less than <math>180^\circ</math> and more than <math>0^\circ</math> . . . . .</i>	12
3.7	<i>The total rolling of the measuring wheel. . . . .</i>	13
3.8	<i>The swept area is <math>ls</math>. . . . .</i>	14
3.9	<i>The swept area is <math>hl</math>. . . . .</i>	14
3.10	<i>The line parallel moves on itself then the area is 0. . . . .</i>	15
3.12	<i>A motion is formed by rotation and parallel shifting. <math>(\vec{N} \nparallel \vec{T})</math> . . . . .</i>	16
3.13	<i>General case, the total distance measured <math>P = \int \vec{N} \cdot \vec{T} ds</math>. . . . .</i>	16

3.14	<i>The wheel is attached at the middle of the segment.</i>	17
3.15	<i>An infinitesimal strip.</i>	18
3.16	<i>An infinitesimal band.</i>	18
3.17	<i>The horizontal motion.</i>	19
3.18	<i>Making cylinder.</i>	19
3.19	<i>For the general position of the wheel during the general motion of the segment.</i>	20
3.20	<i>At each <math>t</math>, the length of <math>\vec{v}</math> is <math>\lambda</math> and the vectors <math>\vec{N}</math> and <math>\vec{v}</math> are perpendicular.</i>	21
3.21	$\vec{N} \cdot \vec{T} > 0$	22
3.22	$\vec{N} \cdot \vec{T} < 0$	22
3.23	$-(A + B) + (B + C) = C - A.$	22
3.24	<i>The generated region <math>A</math> is a circular arc.</i>	23
3.25	<i>The generated region <math>A</math> is a segment.</i>	24
4.1	<i>Examples of simple closed, positively oriented and piecewise smooth curves, where <math>R</math> is the interior and <math>C</math> is boundary of the regions.</i>	25
4.2	<i>The vector fields <math>F(x, y) = \left(-\frac{y}{2}, \frac{x}{2}\right).</math></i>	26
4.3	<i>The vector fields <math>F(x, y) = (0, x).</math></i>	27
4.4	<i>At each point of the annulus there is a normal vector <math>\vec{N}</math> of tracer arm at tracer.</i>	28
4.5	<i>The vector field of the polar planimeter has circular symmetry.</i>	30
4.6	<i>The circumferential component of <math>\vec{N}</math>.</i>	30

4.7	<i>A convenient curve <math>\Gamma</math> with the paths <math>C_1, C_2, C_3</math> and <math>C_4</math>.</i>	31
4.8	<i>At each point of the reachable region, there is a unit normal vector <math>\vec{N}</math> of tracer arm at tracer.</i>	33
4.9	<i>The unit normal vectors of the tracer arm form parallel bands to the tracer line.</i>	34
4.10	<i>The <math>y</math> axis is the tracer line.</i>	34
4.11	<i>An appropriate rectangle bounded by the directed segments <math>C_1, C_2, C_3</math> and <math>C_4</math>.</i>	35
4.12	<i>Understanding the dot product of <math>\vec{N}</math> and <math>\vec{T}</math> over the paths <math>C_2</math> and <math>C_4</math>.</i>	36
5.1	<i>The mechanics of the polar planimeter.</i>	38
5.2	<i>The computation of <math>\sin \gamma</math>.</i>	40
5.3	<i>The mechanics of the linear planimeter.</i>	43



## Chapter 1

### Introduction

The history of approximating and computing areas goes back to 3000 BC, when the ancient Egyptians used equations to approximate the area of circles. A great deal of knowledge on computing areas was summarized by Euclid around 300 BC in his book entitled *Elements*. Archimedes is credited for discovering basic area and volume formulas around 250 BC. At the beginning of the 16th century Johann Kepler studied the area of various conic sections and was able to formulate his three laws of planetary motion. Undoubtedly the discovery of modern time calculus by Isaac Newton and Wilhelm Leibnitz around 1660 was the biggest advancement in area computation. Since then the Fundamental Theorem of Calculus is used to determine areas under the graphs of given functions. At the beginning of the 19th century, practical mechanical tools, called planimeters, were patented for determining the area of planar regions. There is an extensive literature devoted to the mathematics of planimeters. It turned out that the Green's theorem is the main tool at explaining why these ingenious measuring tools work. The purpose of this thesis is to review these papers, understand how to make some of the intuitive arguments precise.

It is fair to say that the difficulty of computing areas depends on the type of region whose area we are interested in. To illustrate when is it simple to compute areas, we start by considering the case of polygons.

Chapter 2 contains two theorems; the first of them explains how determines the area of a triangle whose vertices are given by coordinates and the second is a generalisation of this result for general, not necessarily convex polygons. Since the area formulas are easy to program, one can imagine that approximating areas of general regions is an easy job for computers.

Before the time of computers it was harder to approximate areas. A somewhat forgotten ingenious device called planimeter was invented in 1814 to satisfy the need of land surveyors and other real life applications. There is an extensive literature devoted to the mathematics of planimeters.

Chapter 3 starts with the technical description and the brief history of the planimeters. In order to understand the principles of the linear and polar planimeters we study the planar region swept by moving a line segment. In fact we assume that a measuring wheel is attached to the segment so that the axis of the wheel is parallel to the segment and calculate how much the wheel turns during a motion of the segment.

This section is based on a Casselman's paper [4], it turns out that the relation between the total rolling of the measuring wheel and the swept area during a motion is explained best by Guldin-Pappus theorem(1641)[4]. Suppose the endpoints of a moving line segment traverse on the closed curves  $A$  and  $B$ . The Moving Segment Theorem intuitively says that signed area swept out by the segment is the difference between the areas enclosed by the curve  $A$  and  $B$ . The trick of the planimeters is that one endpoint of the moving segment (tracer arm) is forced to move back and forth on line segment and force on a piece of curve, so that area enclosed by  $A$  is 0, while the measuring wheel reads the swept area, which by the Moving Segment Theorem has to be equal to the area of the region enclosed by  $B$ .

In Chapter 4, the correctness of planimeters is proved by Green's theorem without evaluating the double integral. As a special case of Green's theorem we have the following: If the curl of a vector field which satisfies the requirements of Green's theorem is equal to 1, then the double integral of the curl over a bounded region is equal to the area of the region. Following the method of Casselman such vector field is presented in Chapter 4. We use a similar approach to show the correctness of the linear planimeter.

In Chapter 5, mathematics behind planimeter is verified by Green's theorem with evaluating the double integral. This proof was done in case the polar arm and the tracer arm are equal to 1. In addition to presenting the work of Gatterdam [1] we prove the same for

the general case i.e. if the polar arm and the tracer arm can be of any length. Also a direct proof for the linear planimeter is given here.

## Chapter 2

### Two Area Formulas for Polygons

In this chapter, the calculation of triangles' areas and simple polygons' areas are formulated in the analytic coordinate system.

Let  $A(x_1, y_1)$ ,  $B(x_2, y_2)$  and  $C(x_3, y_3)$  be corners of triangle  $ABC$  where the points  $A$ ,  $B$  and  $C$  are not linear and  $A(ABC)$  is its area in the analytic coordinate system.

**Theorem 2.1.** *The area of triangle  $ABC$  is equal to*

$$\frac{1}{2} |(x_3y_2 - x_2y_3) - (x_3y_1 - x_1y_3) + (x_2y_1 - x_1y_2)| = \frac{1}{2} \begin{vmatrix} x_1 & y_1 & 1 \\ x_2 & y_2 & 1 \\ x_3 & y_3 & 1 \end{vmatrix}$$

*Proof.* Let's representatively in Figure 2.1 the triangle  $ABC$  is drawn. Let's calculate the areas  $K$ ,  $L$ ,  $M$  and the rectangle's area  $R$ .

$$K = \frac{1}{2}(x_3 - x_1)(y_1 - y_3),$$

$$M = \frac{1}{2}(x_2 - x_1)(y_1 - y_2),$$

$$L = \frac{1}{2}(x_2 - x_3)(y_2 - y_3),$$

and the area of the rectangle is

$$R = (x_2 - x_1)(y_1 - y_3).$$

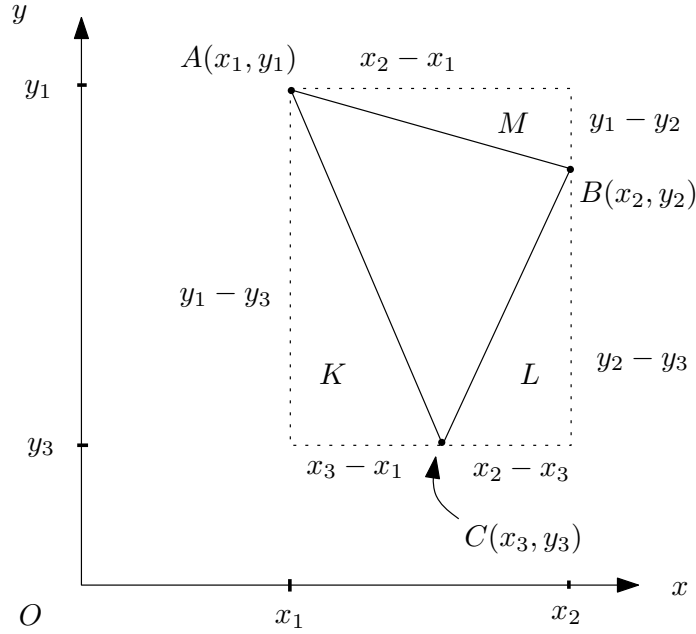

Figure 2.1 A three angle

Then the area  $A(ABC)$  is equal to  $R - (K + M + L)$

$$\begin{aligned}
 A(ABC) &= R - (K + M + L) \\
 &= (x_2 - x_1)(y_1 - y_3) \\
 &\quad - \left( \frac{1}{2}(x_3 - x_1)(y_1 - y_3) + \frac{1}{2}(x_2 - x_1)(y_1 - y_2) + \frac{1}{2}(x_2 - x_3)(y_2 - y_3) \right) \\
 &= \frac{1}{2} |(x_3y_2 - x_2y_3) - (x_3y_1 - x_1y_3) + (x_2y_1 - x_1y_2)| \\
 &= \frac{1}{2} \begin{vmatrix} x_1 & y_1 & 1 \\ x_2 & y_2 & 1 \\ x_3 & y_3 & 1 \end{vmatrix}
 \end{aligned}$$

Here we use the absolute value because this theorem is satisfied for all order cases of the corners. □

The next theorem is about the calculation of simple polygons' areas.

**Definition:** A polygon is simple if it is without self-intersection and closed.

**Theorem 2.2.** Let  $P_i = (x_i, y_i)$  be vertices of a simple polygon  $P$  then its area is equal to

$$\frac{1}{2} \left| \sum_{i=1}^n (x_i y_{i-1} - x_{i-1} y_i) \right| \quad (*)$$

*Proof.* Let start with a simple oktagon to show that its area's formula verifies the equation (\*) (Figure 2.2).

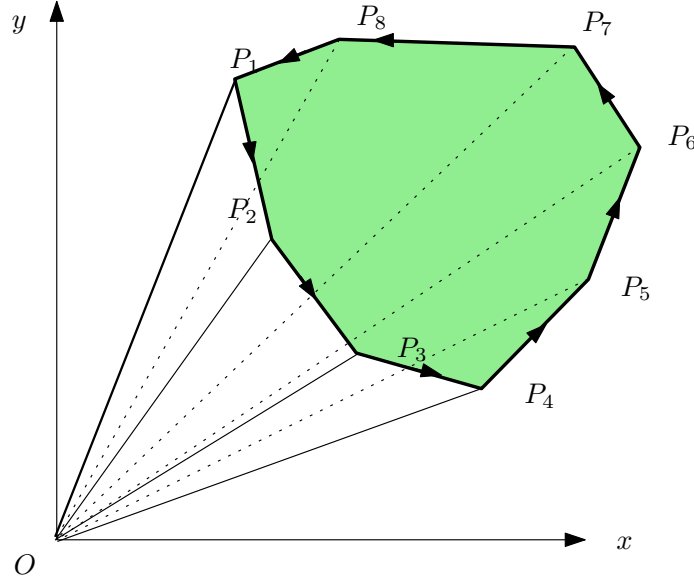

Figure 2.2 A simple octagon

Here the octagon's area is equal to  $|A(OP_4P_5) + A(OP_5P_6) + A(OP_6P_7) + A(OP_7P_8) + A(OP_8P_1) - A(OP_1P_2) - A(OP_2P_3) - A(OP_3P_4)|$ .

Here, if we choose a common direction and do not use the absolute value for all triangles the areas will have a common sign and without loss generality let direction be counterclockwise. Let's calculate the triangle areas by Theorem 2.1.

$$A(OP_1P_2) = \frac{1}{2}(x_2y_1 - x_1y_2),$$

$$A(OP_2P_3) = \frac{1}{2}(x_3y_2 - x_2y_3),$$

$$A(OP_3P_4) = \frac{1}{2}(x_4y_3 - x_3y_4),$$

$$\begin{aligned}
A(OP_4P_5) &= \frac{1}{2}(x_4y_5 - x_5y_4), \\
A(OP_5P_6) &= \frac{1}{2}(x_5y_6 - x_6y_5), \\
&\vdots \\
A(OP_8P_1) &= \frac{1}{2}(x_8y_1 - x_1y_8)
\end{aligned}$$

Therefore "the sign area" of the octagon is equal to

$$\begin{aligned}
&\frac{1}{2}(x_4y_5 - x_5y_4) + \frac{1}{2}(x_5y_6 - x_6y_5) + \dots + \frac{1}{2}(x_8y_1 - x_1y_8) \\
&- \frac{1}{2}(x_2y_1 - x_1y_2) - \dots - \frac{1}{2}(x_4y_3 - x_3y_4) \\
&= \frac{1}{2}(x_1y_2 - x_2y_1 + x_2y_3 - x_3y_2 + x_3y_4 - x_4y_3 \dots x_8y_1 - x_1y_8) \\
&= \frac{1}{2} \sum_{i=1}^8 (x_iy_{i-1} - x_{i-1}y_i)
\end{aligned}$$

Actually if we carefully consider the direction of the octagon we will see that we have an easy way to decide which triangles will be subtracted i.e. we need to calculate only each triangle's area by the direction of the common edge with the octagon and then sum all the results. This process can be done for all simple polygons and their area can be found by equation (\*). □

## Chapter 3

### Planimeters

How can one measure area of two-dimensional shapes, such as leaves, foot soles or bird's wings? This question was studied at the beginning of the 19th century and was answered by a mechanical measuring device called planimeter. Planimeters were designed to determine the exact areas of shapes drawn on a photo or on a sheet of paper. The first planimeter concept is attributed to Johann Martin Hermann, Germany, 1814. However the first prototype was built by the Swiss mathematician Jakob Amsler-Laffon only in 1856. Today, most of planimeters are digital tools.

The best known planimeters are the linear and the polar planimeters. The latter is also known as the Amsler planimeter.

#### **3.1 Description of the Linear Planimeter**

The main component of the linear planimeter is the tracer arm (Figure 3.1). One of its ends is called a pivot and moves only on a straight line (tracer line), as forward and backward, and the other end is the tracer, which traces out a curve counter clockwise. During the motion, the arm freely rotates on the pivot. There is a measuring wheel attached to the tracer arm that rolls during the motions of the tracer while a dial stays in contact with the wheel and records how much the total rolling of the wheel is.



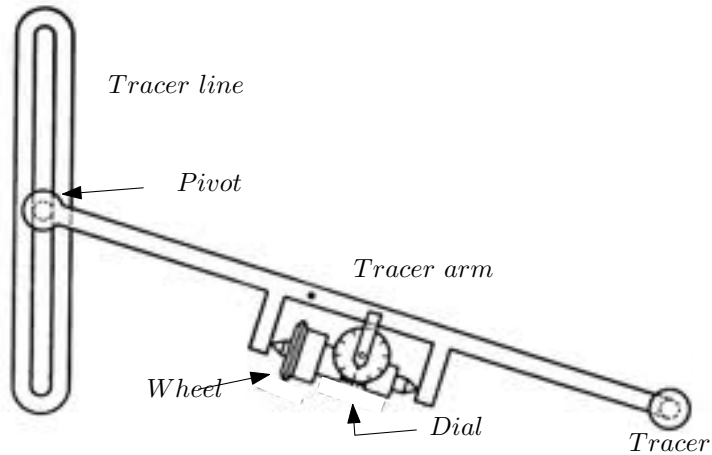

Figure 3.1 *Technical drawing of the linear planimeter*

The linear planimeter measures the total rolling of the wheel by tracing the boundary of a measured region at the counterclockwise direction. Note that in mathematics the counterclockwise direction is defined as positive direction. Since the tracer arm's length  $t$  is a given constant, the tracer can reach a point which must be at most a distance  $t$  from the tracer line. We will require that no point of the curve is exactly at a distance  $t$  from the tracer line. We can assume that throughout tracing the tracer arm forms an angle  $\theta$  with the tracer line which is less than  $90^\circ$ . So the angle  $\theta$  is  $-90^\circ < \theta < 90^\circ$ . ( $\theta$  is negative if the tracer point is on the left from the tracer line and is positive otherwise.) (Figure 3.2).

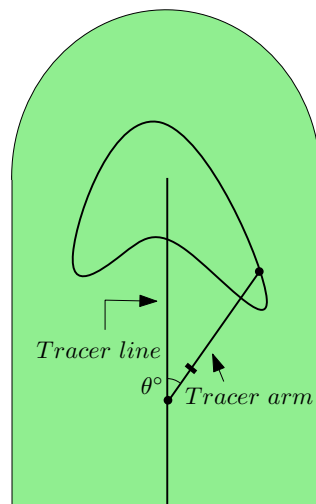

Figure 3.2 *The reachable region of the linear planimeter and  $-90^\circ < \theta < 90^\circ$*

### 3.2 Description of the Polar Planimeter

The polar planimeter, in addition to the tracer arm, has a pole and a polar arm. The pole point is fixed outside of the region enclosed by the curve, and it is joined to the tracer arm through the polar arm. The polar arm rotates freely on the pole. The other end of the polar arm, called pivot, joins the polar and the tracer arms together, and they rotate easily on the pivot. The other end of the tracer arm, called tracer, is designed to trace out the curve counter clockwise. Similarly to the linear planimeter, the tracer arm of the polar planimeter has a wheel and a dial.

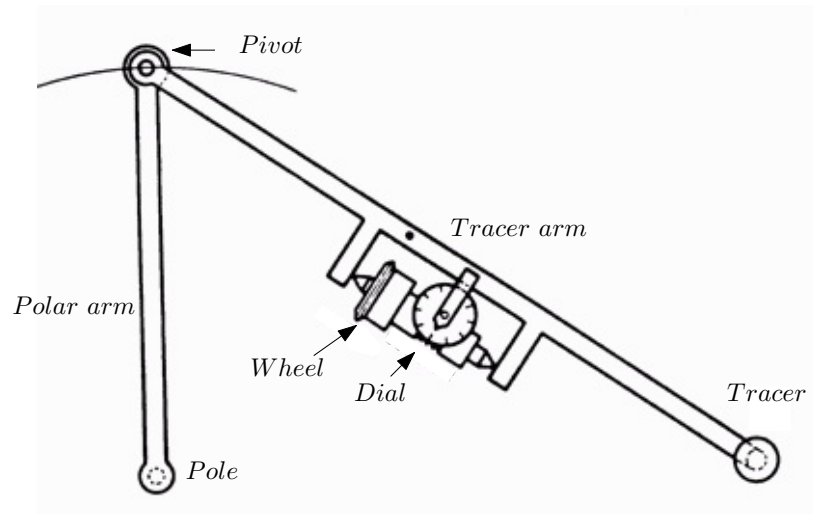

Figure 3.3 *Technical drawing of the polar planimeter*

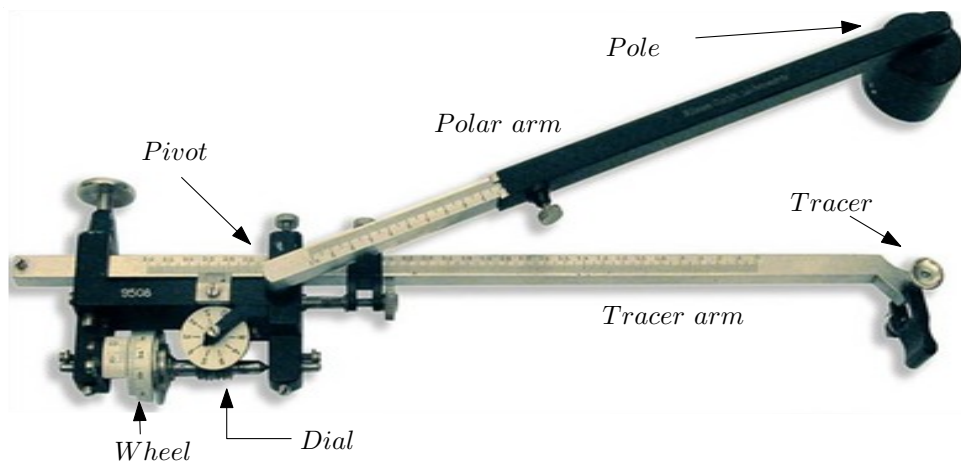

Figure 3.4 *The polar planimeter*

The polar planimeter, like the linear planimeter, measures the total rolling of the wheel when a closed curve is traced out counter clockwise. The lengths of the polar and of the tracer arms are restricted and the former length  $l$  is longer than the latter length  $t$ . Therefore, the planimeter cannot reach outside of the circle of radius  $l + t$  and points inside of the circle of radius  $l - t$ . The curve which will be traced must lie in the annulus which is formed by intersection of the interior of the circle, radius  $l + t$  and the exterior of the circle, radius  $l - t$  (Figure3.4).

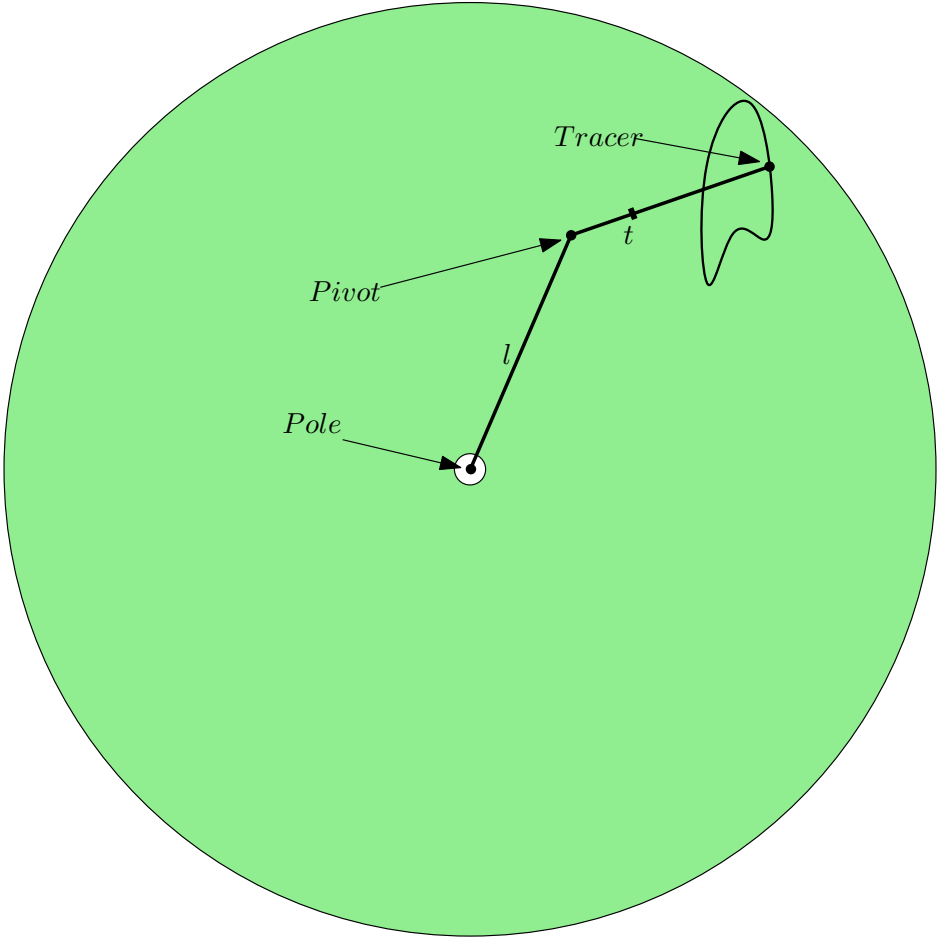

Figure 3.5 Traceable annulus area

In order to avoid any confusion, we want to determine uniquely the positions of the polar and tracer arms in the annulus for each point of the curve. Hence first we define the angle between the polar arm and the tracer arm as  $(0^\circ < \alpha^\circ < 360^\circ)$ , the angle of the

counter-clockwise rotation around the pivot which takes the polar over the tracer arms. The position of the pivot is uniquely determined if we require that the angle  $\alpha$  is  $0^\circ < \alpha < 180^\circ$ . Furthermore, for some critical reasons, which will be explained in the following sections, the pole must be outside of the region enclosed by the curve.

As it is seen in Figure 3.5, once the pivot is in the required position than it automatically remains in the required position as the tracer traces the curve.

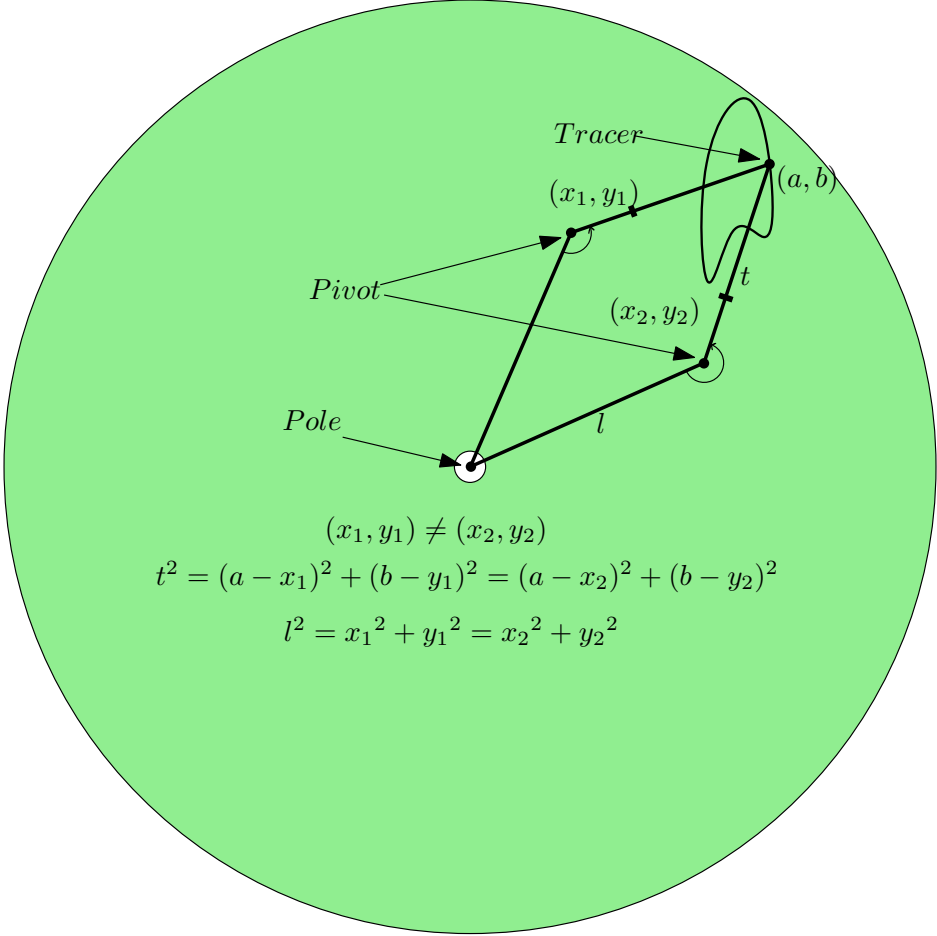

Figure 3.6 To uniquely determine the position of the tracer on the curve, the angle between the polar and the tracer arm must be less than  $180^\circ$  and more than  $0^\circ$

Understanding the theory behind the planimeters depends on a good understanding of the total rolling of a wheel during shifting and rotating a line which has an attached wheel whose axis is parallel to the line. It will turn out that the area of a closed curve is equal to

the total rolling times the length of the tracer arm. In the next section the total rolling of the measuring wheel will be discussed.

### 3.3 Total Rolling of the Planimeters Measuring Wheel and the Swept Area

In this section we study the motion of the tracer arm (and the wheel attached to the tracer arm) independently from the rest of the mechanics and the swept area. Here the tracer arm is just a segment with a wheel attached to it.

Let us start with a simple observation. If the axis of the measuring wheel is perpendicular to the path throughout the entirely motion, then the measuring wheel totally rolls an angle  $\theta = \frac{P}{R}$ , where  $P$  is a distance and  $R$  is the wheel's radius (Figure 3.7).

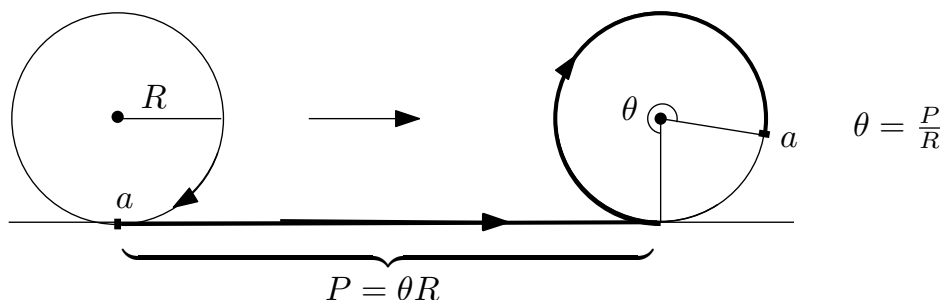

Figure 3.7 *The total rolling of the measuring wheel.*

Therefore the rotation of the wheel is related to the traced path, but this relation is a bit subtle, especially if we want to understand its connection to the area swept by the tracer arm. In the rest of this section we consider a line segment that has a measuring wheel whose axis is parallel to it.

We will use the following notations:  $\Gamma$  denotes the path traversed by the center of the wheel and  $\vec{N}$  denotes the normal unit vector of the line segment and  $\vec{T}$  denotes the unit direction vector of the path  $\Gamma$  at each point.

**Theorem 3.1.** *During a motion of the segment on curve  $\Gamma$ , total rolling of the wheel is equal to*

$$\int_{\Gamma} \vec{N} \cdot \vec{T} ds$$

If the segment moves perpendicular to itself a distance  $s$ , then  $\vec{T} = \vec{N}$  and the measuring wheel rolls a distance  $s$ ; furthermore, the swept area is  $ls$ , where the segment's length is  $l$  (Figure 3.8).

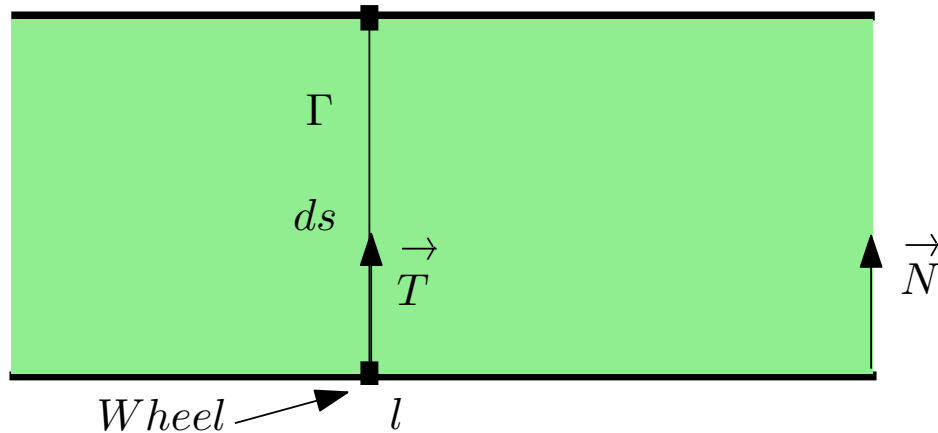

Figure 3.8 The swept area is  $ls$ .

However, if the line segment is shifted on a line segment, then the wheel rotates a distance  $h$  which is the height of the parallelogram and the swept area is equal to  $hl$  (Figure 3.9).

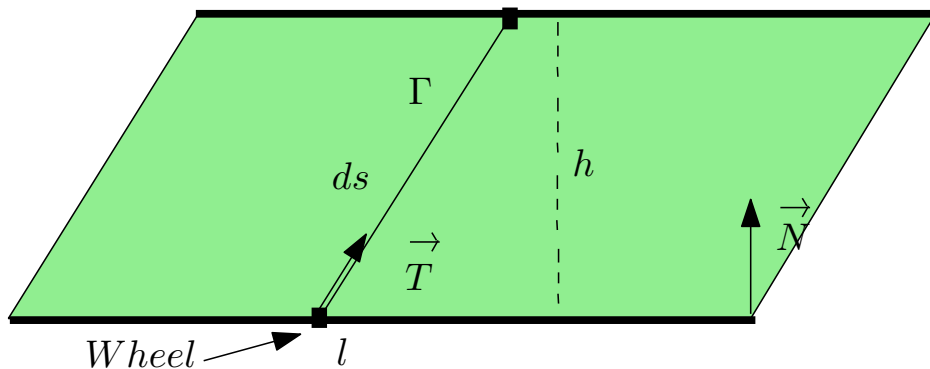

Figure 3.9 The swept area is  $hl$ .

If the line parallelly moves on itself then, the wheel will not roll at all, so the swept area is equal to 0 (Figure 3.10).

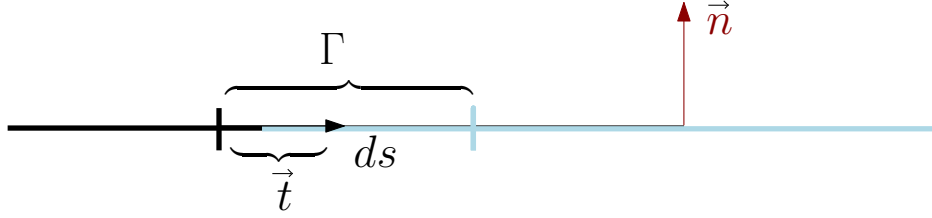
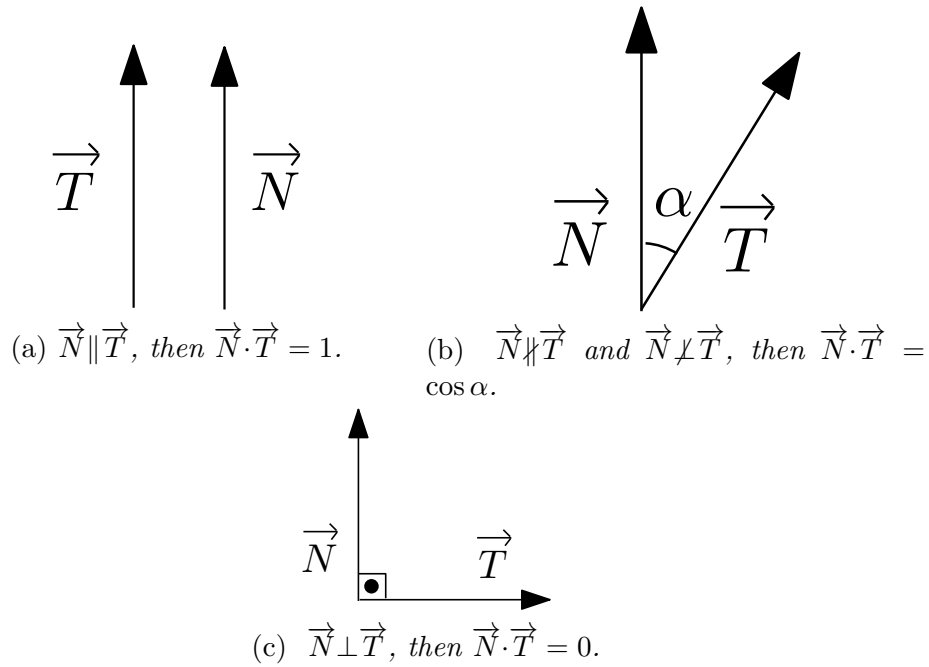

Figure 3.10 *The line parallel moves on itself then the area is 0.*

From the above results, when a segment is translated, the swept area directly depends on the distance  $P$ , which is measured by the wheel and the length  $l$  of the segment.

In all cases, the total rolling of the wheel basically depends on the magnitudes of the unit vectors  $\vec{T}$  and  $\vec{N}$  at each point of the path. Therefore, in the first case, since  $\vec{N} \parallel \vec{T}$ , the dot product  $\vec{N} \cdot \vec{T} = 1$ , then the moved distance of the wheel is exactly equal to the length of the traced path. In the second case, the vectors  $\vec{N}$  and  $\vec{T}$  are neither parallel ( $\vec{N} \not\parallel \vec{T}$ ) nor perpendicular ( $\vec{N} \not\perp \vec{T}$ ), and so the dot product  $\vec{N} \cdot \vec{T}$  is equal to  $l$  times the height  $h$  of the parallelogram. In the third case, the vectors  $\vec{N}$  and  $\vec{T}$  are perpendicular i.e. ( $\vec{N} \perp \vec{T}$ ), therefore  $\vec{N} \cdot \vec{T} = 0$ .



Therefore, when the motion of the line is parallel to itself, then the total distance measured by the wheel  $P$  is equal to  $\int \vec{N} \cdot \vec{T} ds$ . Actually this basic result is valid for general motions because they can be approximated by a sequence of rotations and translations.

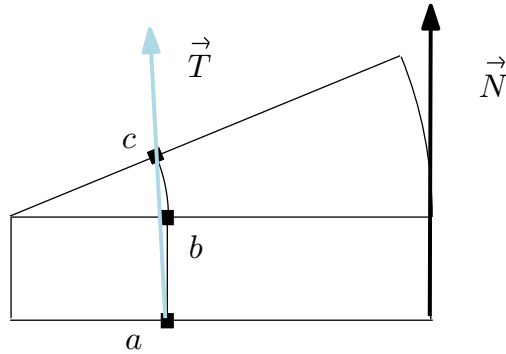

Figure 3.12 A motion is formed by rotation and parallel shifting.  $(\vec{N} \parallel \vec{T})$

Infinitesimally, the distance which is displayed on the dial, while it moves from  $a$  to  $c$  is equal to the distances which are displayed when it moves from  $a$  to  $b$  and from  $b$  to  $c$  so

$$P = \int \vec{N} \cdot \vec{T} ds$$

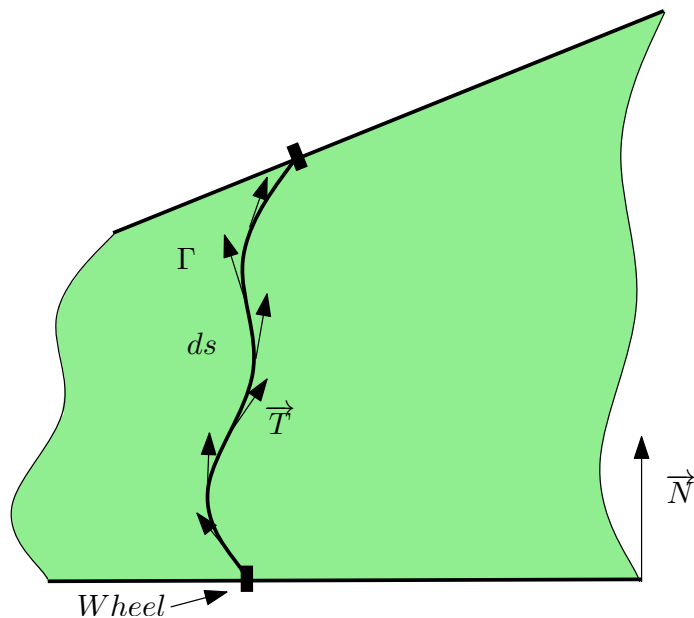

Figure 3.13 General case, the total distance measured  $P = \int \vec{N} \cdot \vec{T} ds$ .



We already saw that in cases of various parallel line motions the swept area is equal to the product of the total rolling of the wheel and the length of the line segment. However, this is not true for general motions unless the wheel is attached at the middle of the segment. In the next section, Guldin-Pappus theorem is given, which shows how to calculate the area in terms of the rotation of the wheel and the length of the segment in case of non-parallel motions.

Assume we have a plane curve  $C$  and an external segment  $l$  in the plane.

**Theorem 3.2** (Guldin-Pappus Theorem (1641)). *If the curve revolves about the line then the surface area of the solid of the revolution is equal to the length of the curve times the circumference of the circle obtained by the rotating which passes through the centroid of the curve along the line.*

Here, we do not give the proof but the relation of the line sweeping and the area is explained.

Suppose that the wheel of radius  $R$  is attached at the middle of the line segment. Then, if the wheel rolls an angle  $\theta$  at the end of the motion, the measuring wheel rolls a distance  $P = R\theta$  and so the swept area by the segment is  $Pl$ .

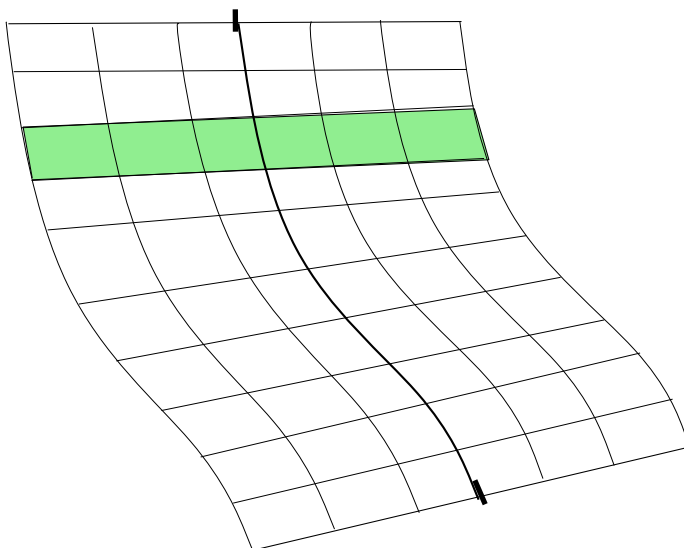

Figure 3.14 *The wheel is attached at the middle of the segment.*

If we infinitesimally partition the swept area as shown above, then we get the strips below.

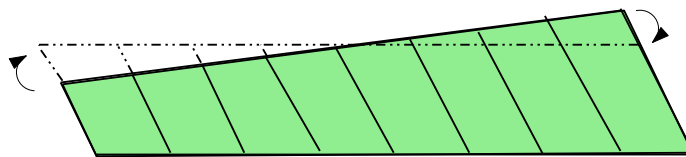

Figure 3.15 *An infinitesimal strip.*

For each of the strips, when the upper line is rotated to make it parallel to the bottom line as in Figure 3.15, the wheel does not roll because it is at the middle of the line. Moreover, for an infinitesimal partition, the area is not changed because the area lost to the right of the midpoint is equal to the area gained to the left from the midpoint. Applying the same argument for each strip, then we get a combination of parallel line motions (Figure 3.16).

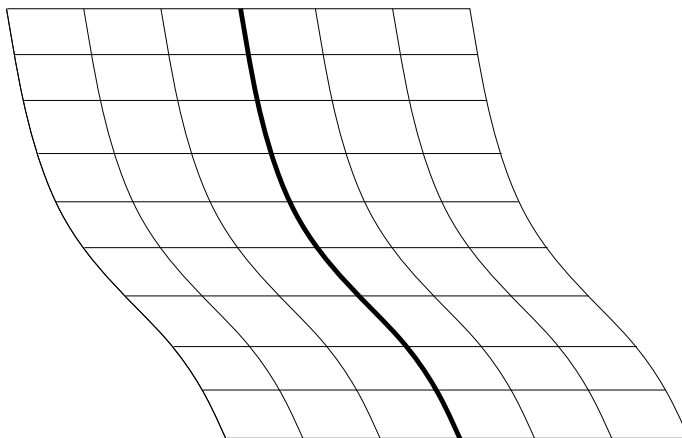

Figure 3.16 *An infinitesimal band.*

As in seen in Figure 3.17, if we horizontally slide the right side of the swept area to the left, the measuring wheel does not roll because the motion is paralel to its axis and the area is not change.

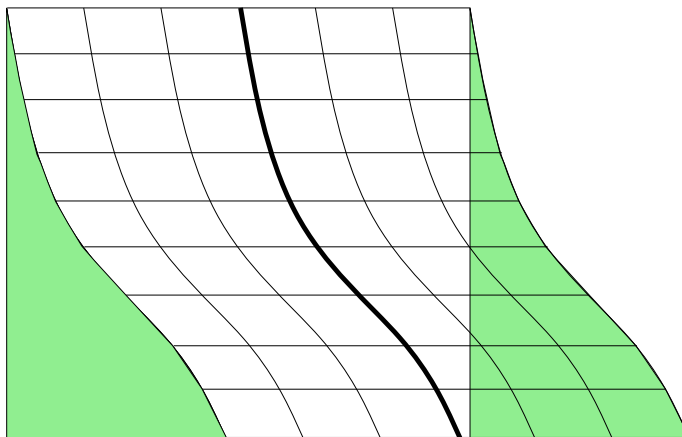

Figure 3.17 *The horizontal motion.*

Then, the swept area can be turned into a cylinder and its surface area is the length of the segment times the total rolling of the measuring wheel i.e. total swept area is  $Pl$ . (Figure 3.18.) Therefore the theorem is verified for the line segment sweeping.

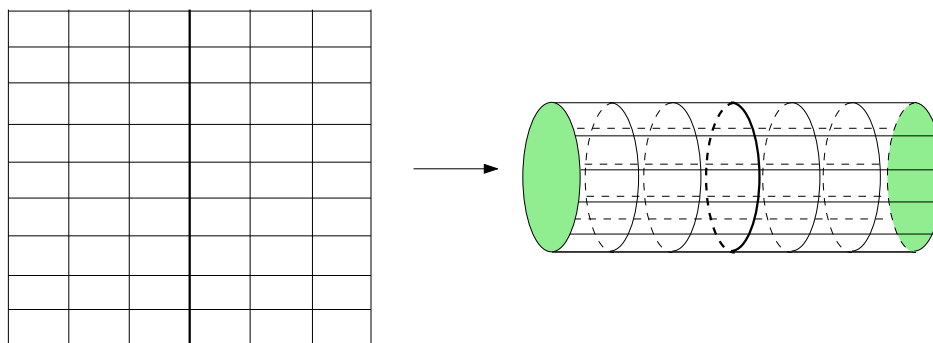

Figure 3.18 *Making cylinder.*

However, during the parallelization process, one end of the line goes up and the other goes down. In general, this fact will be considered a signed interpretation.

This result is valid when the wheel is at the middle of the line. However one might wonder what will happen if the wheel is placed somewhere else of the line.

Let the wheel be far away from the middle of the segment and its position vector at time  $t$  be  $\vec{v}(t) + \vec{c}(t)$  where  $\vec{c}(t)$  is the middle point of the segment and  $\vec{v}(t)$  is a vector which lies on the segment with a fixed length  $\lambda$  (Figure 3.19). The wheel traces a curve  $\Gamma(t)$  parametrized by  $\Gamma(t) = \vec{v}(t) + \vec{c}(t) = (x(t), y(t))$ .

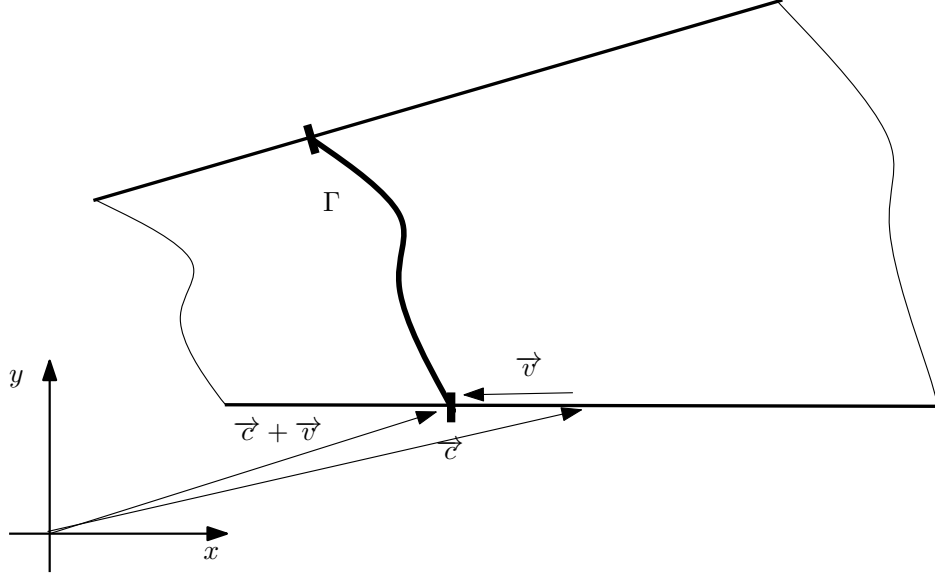

Figure 3.19 For the general position of the wheel during the general motion of the segment.

Let us recall that  $P = \int_{\Gamma} \vec{N} \cdot \vec{T} ds$ . Here, the unit direction vector  $\vec{T}$  is  $\frac{(x'(t), y'(t))}{\sqrt{x'(t)^2 + y'(t)^2}}$  and the elementary arc length is  $ds = |\Gamma'(t)|dt = \sqrt{x'(t)^2 + y'(t)^2}dt$ . Therefore;

$$\begin{aligned}
 P &= \int_{\Gamma} \vec{N} \cdot \vec{T} ds \\
 &= \int_{\Gamma} \vec{N} \cdot \frac{(x'(t), y'(t))}{\sqrt{x'(t)^2 + y'(t)^2}} \sqrt{x'(t)^2 + y'(t)^2} dt \\
 &= \int_{\Gamma} \vec{N} \cdot (x'(t), y'(t)) dt \\
 &= \int_{\Gamma} \vec{N} \cdot (\vec{c}'(t) + \vec{v}'(t)) dt \\
 &= \underbrace{\int_{\Gamma} \vec{N} \cdot \vec{c}'(t) dt}_1 + \underbrace{\int_{\Gamma} \vec{N} \cdot \vec{v}'(t) dt}_2.
 \end{aligned}$$

Here, the integral (1) would be the distance of the wheel's motion if it were at the middle of the segment. In the integral (2), since  $\vec{N}(t)$  is the normal vector of the line in which the vector  $\vec{v}(t)$  lies,  $\vec{N}(t)$  and  $\vec{v}(t)$  are perpendicular ( $\vec{N}(t) \perp \vec{v}(t)$ ) (Figure 3.20), the vector  $\vec{v}(t)$  travels around a circle of radius  $\lambda$ .

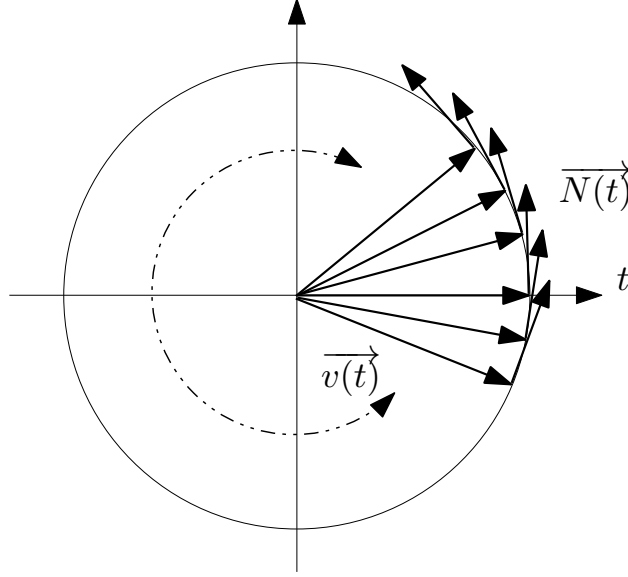

Figure 3.20 At each  $t$ , the length of  $\vec{v}$  is  $\lambda$  and the vectors  $\vec{N}$  and  $\vec{v}$  are perpendicular.

Thus  $\vec{v}(t)'$  is parallel to  $\vec{N}$ , and their dot product is the signed length of  $\vec{v}(t)'$ . Therefore, the integral (2) is equal to *the total rotation of the segment times  $\lambda$* .

Therefore, when the total *line* rotation is  $\beta$  and the wheel is at distance  $\lambda$  from the center of the segment, the distance  $P$  is measured  $P_c$  plus  $\lambda$  times  $\beta$  i.e.  $P = P_c + \lambda\beta$  where  $P_c$  is the distance that would be measured if the wheel were at the midpoint.

From this general situation, it can be easily seen that when the wheel is at the midpoint of the segment then the integral (2) is equal to 0 so the total wheel motion would be  $P_c$ .

Therefore by Guldin-Pappus theorem, the swept area is equal to

$$lP_c = lP - l\lambda\beta.$$

**Theorem 3.3.** *If a segment's end points trace two curves  $\Gamma_A$  and  $\Gamma_C$  as the boundaries of the regions  $A$  and  $C$ , respectively, (Figure 3.21 and 3.22) then total swept area is equal to  $C - A$*

*Proof.* Consider the upward motion of the line segment depicted on Figure 3.21. The dot product of the vectors  $\vec{N}$  and  $\vec{T}$  is positive, so the sign of the swept area is positive. The other way the dot product is negative so the sign of the area is negative Figure 3.22.

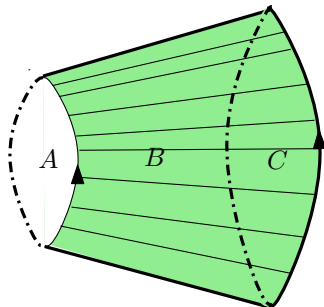

Figure 3.21  $\vec{N} \cdot \vec{T} > 0$

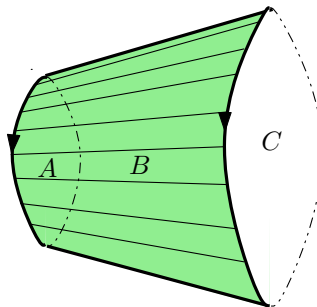

Figure 3.22  $\vec{N} \cdot \vec{T} < 0$

In the figure, when  $\vec{N} \cdot \vec{T}$  is negative, the swept areas  $A$  and  $B$  have negative signs and when  $\vec{N} \cdot \vec{T}$  is positive, the swept areas  $B$  and  $C$  have positive signs. Thus, adding them together yields

$$-(A + B) + (B + C) = C - A$$

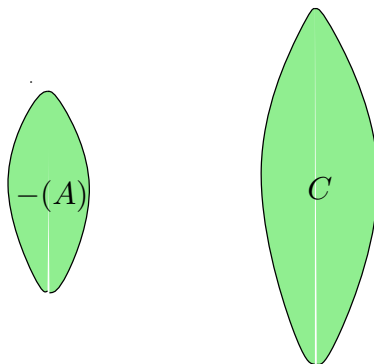

Figure 3.23  $-(A + B) + (B + C) = C - A$ .

Since during the motion of the line segment the total swept area is  $lP_c = lP - l\lambda\gamma$ , we have  $C - A = lP_c = lP - l\lambda\gamma$ . Since the line segment returns to its starting position, so the total rotation of *the line segment*  $\gamma$  is zero, and so,  $C - A = lP$ .  $\square$

If we could choose the area  $A$  to be equal to zero, then the area  $C$  would be exactly equal to the line segment's length  $l$  times the distance  $P$  measured by the rotation of the wheel.

In case of the polar planimeter, one end of the polar arm is fixed at the pole and the other end, called pivot, is connected to the tracer arm and restricted to move on a circular arc, and thus  $A = 0$ . The tracer arm plays the role of the moving segment as the above line segment and travels on a measured curve by the tracer.

**Corollary 3.1** For the polar planimeter, if the pole is outside the measured area and the tracer arm returns to its original position then the total rotating of the tracer arm is zero and the area is  $Pl$ . (Figure 3.24)

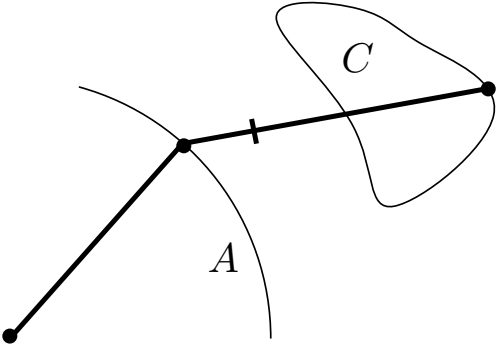

Figure 3.24 *The generated region A is a circular arc.*

Here, since, the area of the arc is zero, the area of the closed region is  $Pl$ .

**Corollary 3.2** If the tracer of the linear planimeter traces the complete boundary then the total rotation of the tracer arm is equal to zero and the swept area is  $Pl$

Since the tracer arm returns to the initial position after tracing the simple closed region, total rotation of tracer arm  $\gamma$  is zero. Since the pivot end moves on the trace line as forward and backward we have that  $A = 0$  and thus the total area is the length of the tracer times the total rolling of the measuring wheel (Figure 3.25).

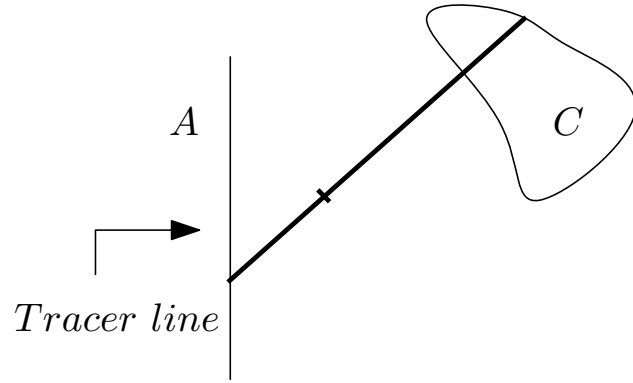

Figure 3.25 *The generated region A is a segment.*



## Chapter 4

### Explaining Planimeters by Green's Theorem Without Evaluating Integrals

In this chapter we are going to prove the planimeter's theorem using Green's theorem. We will start by Green's theorem. Then Green's theorem is applied for the polar and linear planimeters.

#### 4.1 Green's Theorem

Let us recall that a curve is simple closed if the curve does not intersect with itself and closed; it is said to be oriented positively if the boundary  $C$  is the counterclockwise oriented; and it is called piecewise smooth if it is smooth curve with possible finite number of corners. (Figure 4.1)

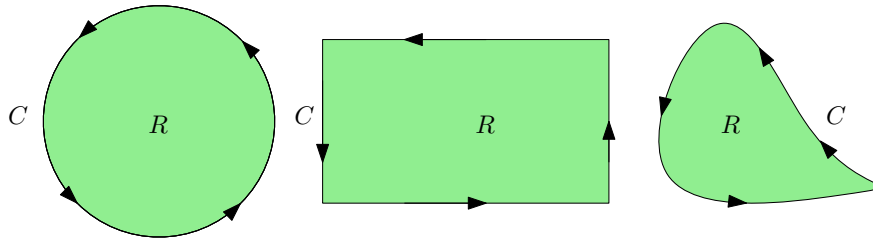

Figure 4.1 *Examples of simple closed, positively oriented and piecewise smooth curves, where  $R$  is the interior and  $C$  is boundary of the regions.*

**Theorem 4.1.** *Let  $D$  be a region with the interior  $R$  and boundary  $C$  which is simple closed, positively oriented and piecewise smooth and let  $\vec{F}(x, y) = \langle P(x, y), Q(x, y) \rangle$  be a vector field where  $P(x, y)$  and  $Q(x, y)$  are functions of two variable and have continuous first order partial derivative over an open region containing  $R$ , then*

$$\oint_C P(x, y)dx + Q(x, y)dy = \int \int_R \left( \frac{\partial Q}{\partial x} - \frac{\partial P}{\partial y} \right) dA.$$

The integrand  $Q_x - P_y$  is called the curl of the vector field.

**Corollary 4.1** If the curl is equal to 1, then the double integral in Green's theorem is the area of the region  $D$ , i.e.

$$\iint_R \left( \frac{\partial Q}{\partial x} - \frac{\partial P}{\partial y} \right) dA = \iint_R dA = \text{area}(D).$$

For example if the vector field  $F(x, y) = \left( -\frac{y}{2}, \frac{x}{2} \right)$  then  $P_y = -\frac{1}{2}$  and  $Q_x = \frac{1}{2}$  so  $Q_x - P_y = \frac{1}{2} - \left( -\frac{1}{2} \right) = 1$ . (Figure 4.2).

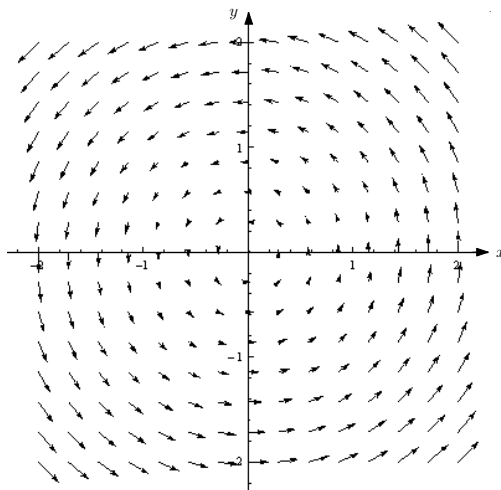

Figure 4.2 The vector fields  $F(x, y) = \left( -\frac{y}{2}, \frac{x}{2} \right)$ .

If the vector field  $F(x, y) = (0, x)$  then  $P_y = 0$  and  $Q_x = 1$ , and so  $Q_x - P_y = 1 - 0 = 1$ . (Figure 4.3).

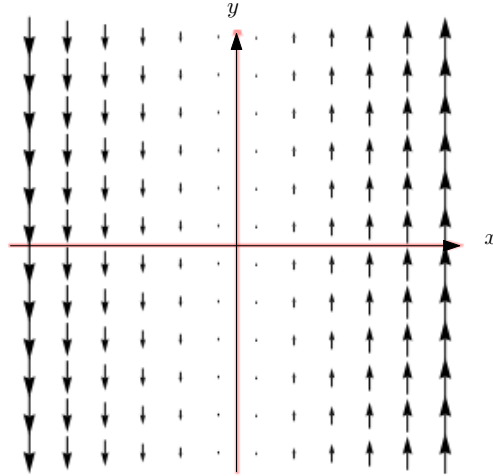

Figure 4.3 *The vector fields  $F(x, y) = (0, x)$ .*

The above examples show us that the vector fields whose line integral on the boundary of a closed region gives us the area of the region is not uniquely determined. In the next section, we are going to show that the product of the curl of the vector fields of the planimeter and the length of the tracer arm is 1.

## 4.2 An Application of Green's Theorem for the Polar Planimeter

We have already chosen the tracer's motion around a closed curve in the positive direction. Since the region is closed, simple then the tracer follows up the boundary  $\Gamma$  which is a continuous curve. For each point of the annulus, we have a unit normal vector  $\vec{N}$  of the tracer arm at the tracer which indicates the counterclockwise.

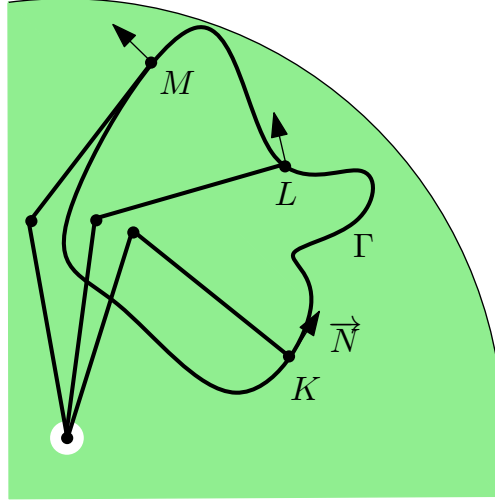

Figure 4.4 At each point of the annulus there is a normal vector  $\vec{N}$  of tracer arm at tracer .

How much does the measuring wheel roll, when the curve is traced along a curve  $\Gamma$ , depends on the angle between the each point of the normal vector  $\vec{N}$  and the tangent vector  $\vec{T}$  of the curve. Figure 4.4 illustrates different possibilities. When the tracer moves a distance  $\Delta s$  on the curve, at K the wheel responds  $\Delta s$ ; at L the result is between  $\Delta s$  and 0; and at M the wheel is not going to roll.

In order to make more clear what is the relation between the measuring wheel's rolling and the normal and tangent vectors on the curve, let  $\vec{N}_i$  for  $i = 1, 2, \dots, n$  denote the normal vectors of tracer arm at a given set of subdivision points of the curve and at these points let  $\vec{T}_i$  be the unit tangent vectors of the curve. Suppose that the tracer travels a distance  $\Delta s_i$  from the  $i$ th to the  $(i + 1)$ th subdivision point on the boundary  $\Gamma$ , then the wheel rolls a distance  $\vec{N}_i \cdot \vec{T}_i \Delta s_i$  where  $\vec{N}_i \cdot \vec{T}_i$  is the dot product of the two vectors. Therefore total rolling of the wheel is

$$\sum_{i=1}^n \vec{N}_i \cdot \vec{T}_i \Delta s_i.$$

The usual limit process gives that the total rolling of the wheel is equal to

$$\lim_{\max\{\Delta s_i\} \rightarrow 0} \sum \vec{N}_i \cdot \vec{T}_i \Delta s_i = \oint_{\Gamma} \vec{N} \cdot \vec{T} ds.$$

Since for a polar planimeter, the angle  $\alpha$  between the tracer and polar arms is  $0^\circ < \alpha < 180^\circ$  the configuration of the planimeter is unique at each point of the annulus. Therefore for each point of the annulus there is a unique normal vector and these vectors gives us a vector field and say it  $\vec{N}(x, y) = (P(x, y), Q(x, y))$ . Since the studied region's boundry  $\Gamma$  is completely included in the annulus where the vector field  $\vec{N}(x, y)$  is defined, by the Green's theorem, the line integral of  $\vec{N}$  on the boundary  $\Gamma$  of the region  $D$  is equal to certain double integral over the interior  $R$  of the region of  $D$ . Therefore,

$$\oint_{\Gamma} \vec{N} \cdot \vec{T} ds = \oint_{\Gamma} P(x, y)dx + Q(x, y)dy = \int \int_R (Q_x - P_y)dA.$$

As we have mentioned that if the curl  $Q_x - P_y$  is equal to 1 then the line integral is equal to the area of the region  $D$ . In fact, instead of showing the curl  $Q_x - P_y$  is 1, for the polar planimeter, we are going to show that the vector field  $t\vec{N}(x, y)$  verifies the property that its curl  $t(Q_x - P_y)$  is 1. Normally, the vector field  $\vec{N}$  would be found and then its curl would be detemined. However we do not directly find the vector field and its curl, instead of this special properties of the vector field will be used to verify that the curl  $t(Q_x - P_y)$  is one. Then by Green's theorem,

$$\begin{aligned} \oint_{\Gamma} t\vec{N} \cdot \vec{T} ds &= \oint_{\Gamma} t(P(x, y)dx + Q(x, y))dy \\ &= \int \int_R t(Q_x - P_y)dA = \int \int_R 1dA = \text{area of } R. \end{aligned}$$

The vector field  $\vec{N}$  has circular symmetry, i.e. in the annulus, the angle between the normal vectors of the tracer arm and tangent vectors of a circle centered at the pole point is constant.

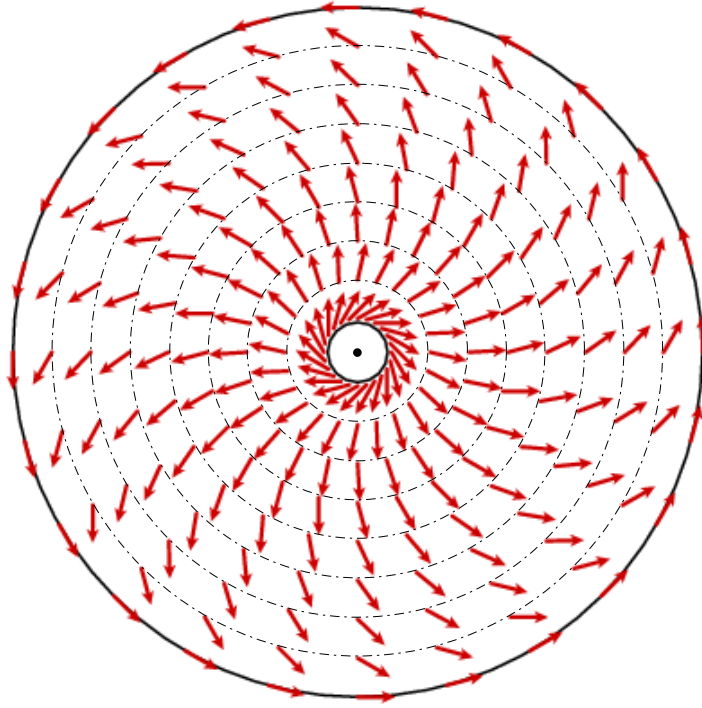

Figure 4.5 *The vector field of the polar planimeter has circular symmetry.*

By the law of cosines, we get a formula which gives the cosine of the angle between the line segment from the pole to the tracer and the tracer arm.

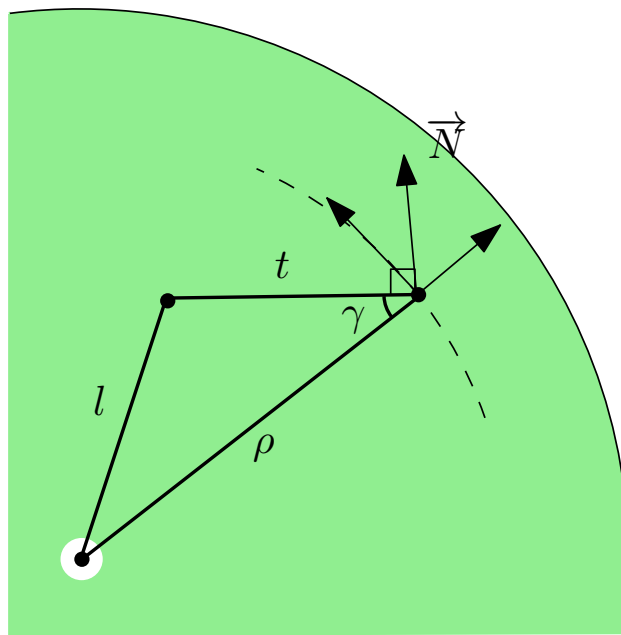

Figure 4.6 *The circumferential component of  $\vec{N}$ .*

Therefore, by Figure 4.6

$$l^2 = t^2 + \rho^2 - 2t\rho \cos(\gamma)$$

which gives

$$\cos(\gamma) = \frac{t^2 + \rho^2 - l^2}{2t\rho}$$

Now, let us define the function  $f$  by  $f(\rho) = \cos(\gamma) = \frac{t^2 + \rho^2 - l^2}{2t\rho}$ .

According to the Green's theorem the line integral on a closed curve of the path integral is equal to the area of the region if the curl of the vector field is equal to 1. Here, instead of directly showing the curl is equal to 1, we show that on an appropriate closed curve in the annulus the line integral of the vector field times  $t$  is the area then this result gives that the curl is 1. For this we choose a convenient curve  $\Gamma$ . (Figure 4.7)

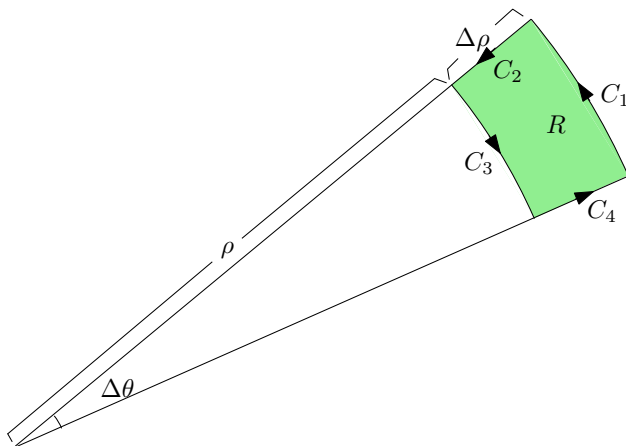

Figure 4.7 A convenient curve  $\Gamma$  with the paths  $C_1$ ,  $C_2$ ,  $C_3$  and  $C_4$ .

Let us show that the area of  $R$  is equal to  $\int \int_R t(Q_x - P_y)dA$ . Let us calculate the line integral of the vector field  $\vec{N}$  along the curve  $\Gamma$ .

$$\oint_{\Gamma} \vec{N} \cdot \vec{T} ds = \int_{C_1} \vec{N} \cdot \vec{T} ds + \int_{C_2} \vec{N} \cdot \vec{T} ds + \int_{C_3} \vec{N} \cdot \vec{T} ds + \int_{C_4} \vec{N} \cdot \vec{T} ds$$

Since the vector field has circular symmetry,

$$\int_{C_2} \vec{N} \cdot \vec{T} ds = - \int_{C_4} \vec{N} \cdot \vec{T} ds.$$

therefore,

$$\begin{aligned} \oint_{\Gamma} \vec{N} \cdot \vec{T} ds &= \int_{C_1} \vec{N} \cdot \vec{T} ds + \int_{C_3} \vec{N} \cdot \vec{T} ds \\ &= \int_{C_1} f(\rho + \Delta\rho) d\theta + \int_{C_3} f(\rho) d\theta \\ &= ((\rho + \Delta\rho)f(\rho + \Delta\rho) - \rho f(\rho))\theta \\ &= \left( (\rho + \Delta\rho) \frac{(\rho + \Delta\rho)^2 + t^2 - l^2}{2t(\rho + \Delta\rho)} - \rho \frac{\rho^2 + t^2 - l^2}{2t\rho} \right) \theta \\ &= \frac{\theta}{2t} ((\rho + \Delta\rho)^2 - \rho^2) \end{aligned}$$

Then  $t$  times the path integral  $\oint_{\Gamma} \vec{N} \cdot \vec{T} ds$  is equal to  $\frac{\theta}{2}((\rho + \Delta\rho)^2 - \rho^2)$  which is the area of the region  $R$  and so by the Green's theorem, we have reached that  $t(Q_x - P_y) = 1$ .

Now, we generalize this result for any simple closed region  $D$  in the annulus using an indirect argument. Let us assume that there is a point  $(x_1, y_1) \in D$  which does not satisfy the result, i.e.  $t(Q_x - P_y)(x_1, y_1) \neq 1$ . Then without loss generality we can assume  $t(Q_x - P_y)(x_1, y_1) > 1$  and since  $t(Q_x - P_y)$  is a continuous function over the annulus, for a sufficiently small neighborhood  $\Delta D$  of the point  $(x_1, y_1)$  the function  $t(Q_x - P_y) > 1$  and so

$$\int \int_{\Delta D} t(Q_x - P_y) dA > \int \int_{\Delta D} 1 dA = \text{area of } \Delta D,$$

a contraction. So the function  $t(Q_x - P_y)$  is the constant function over the annulus.

Therefore, for any simple, closed region  $D$  with boundary  $\Gamma$ , the area is equal to the length  $t$  of the tracer arm times the total rolling  $\oint_{\Gamma} \vec{N} \cdot \vec{T} ds$  of the measuring wheel in the annulus, i.e.

$$\text{area of } D = t \oint_{\Gamma} \vec{N} \cdot \vec{T} ds.$$



### 4.3 An Application of Green's Theorem to the Linear Planimeter

Similarly to the polar planimeter, let  $\Gamma$  be the piecewise continuous boundary curve of the region  $D$ . Assume that the orientation of the tracer's motion of the linear planimeter on a closed curve is positive. For each point of the reachable region there is a unit normal vector  $\vec{N}$  of the tracer arm at the tracer that is consistent with the positive direction.

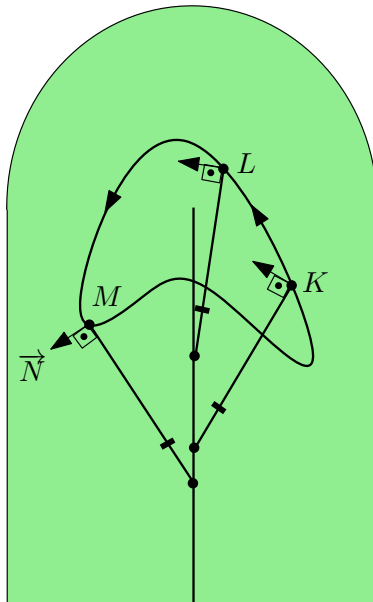

Figure 4.8 *At each point of the reachable region, there is a unit normal vector  $\vec{N}$  of tracer arm at tracer.*

The discussion of how much the measuring wheel rolls along the tracing is the same as that of the polar planimeter's. The unit vectors  $\vec{N}$  and  $\vec{T}$  mean the same as before, therefore, the total rolling of the wheel is  $\oint_C \vec{N} \cdot \vec{T} ds$ . The unit normal vectors of the tracer arm at each point of the reachable region form a vector field  $\vec{N}(x, y)$ . In the vector fields, the vectors on a straight line which is parallel to the tracer line form a vector band that is parallel to the tracer line, i.e. the vectors in a band are parallel to each other. (Figure 4.9)

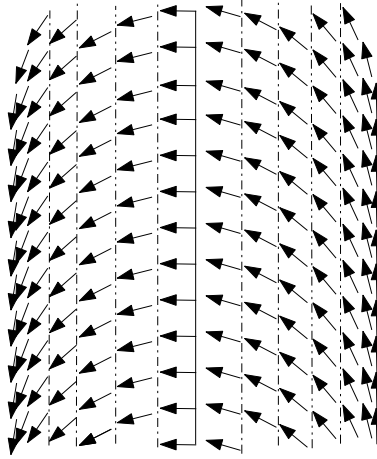

Figure 4.9 *The unit normal vectors of the tracer arm form parallel bands to the tracer line.*

As the properties of the vector field of the polar planimeter were considered to show that the total wheel measuring times the tracer arm's length is the area, here the properties of the vector field associated with the linear planimeter will be considered.

In the  $(x, y)$  coordinate system, let the axis  $y$  be the tracer line and let  $\gamma$  be the angle between the tracer line and the trace arm.

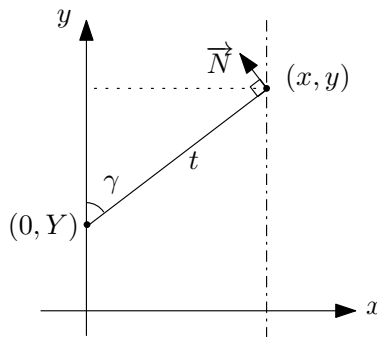

Figure 4.10 *The y axis is the tracer line.*

Let us define the function  $f$  by  $f(x) = \sin(\gamma) = \frac{x}{t}$  and let us choose an appropriate region  $D$  with the boundary  $\Gamma$  to show that the integrand  $t(Q_x - P_y) = 1$ . (Figure 4.11)

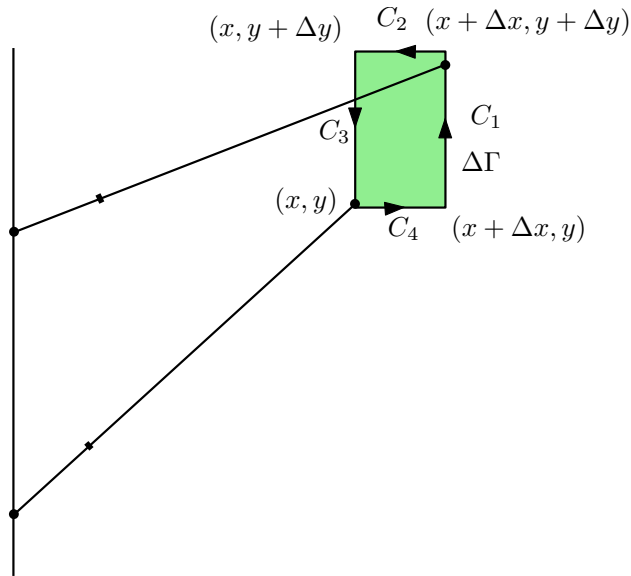

Figure 4.11 An appropriate rectangle bounded by the directed segments  $C_1$ ,  $C_2$ ,  $C_3$  and  $C_4$ .

Using Green's theorem, we are going to show that the area of the rectangle  $R$  is equal to  $\int \int_R t(Q_x - P_y)dA$ . We start by calculating the line integral of the vector field  $t\vec{N}(x, y)$  over the boundary  $\Gamma$ .

$$\oint_{\Gamma} \vec{N} \cdot \vec{T} ds = \int_{C_1} \vec{N} \cdot \vec{T} ds + \int_{C_2} \vec{N} \cdot \vec{T} ds + \int_{C_3} \vec{N} \cdot \vec{T} ds + \int_{C_4} \vec{N} \cdot \vec{T} ds.$$

The line integrals over the paths  $C_2$  and  $C_4$  are just different by sign. To see this, let us calculate the dot product  $\vec{N} \cdot \vec{T}$  for the points  $(x_1, y + \Delta y)$  and  $(x_1, y)$  where  $x_1 \in (x, x + \Delta x)$  in Figure 4.12 ,

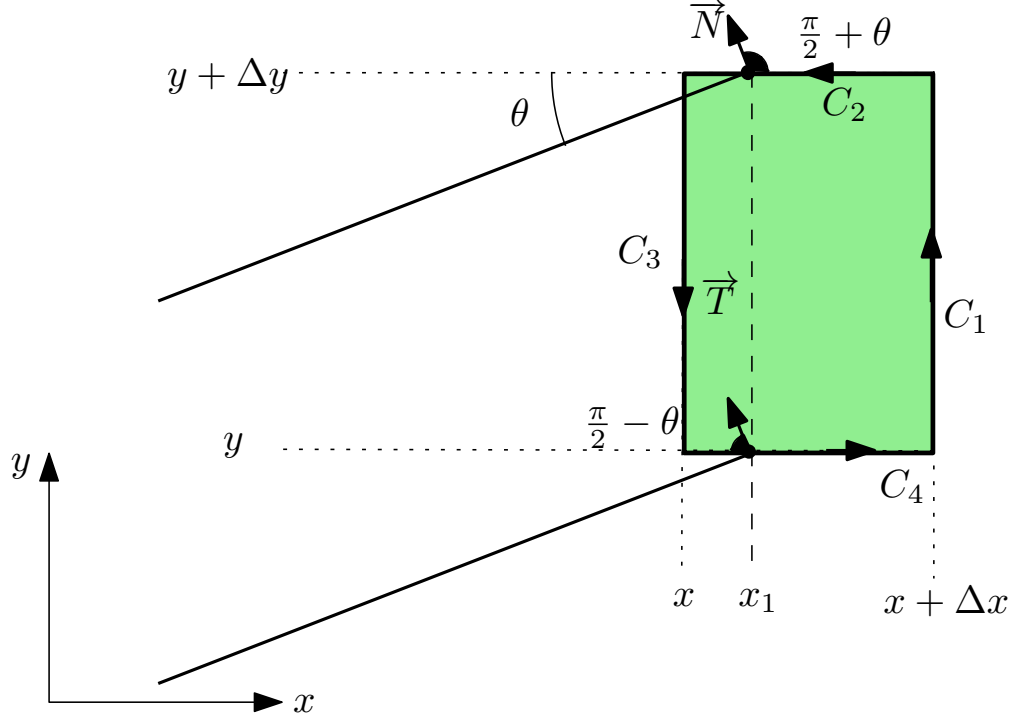

Figure 4.12 Understanding the dot product of  $\vec{N}$  and  $\vec{T}$  over the paths  $C_2$  and  $C_4$ .

We have

$$\vec{N}(x_1, y + \Delta y) \cdot \vec{T}(x_1, y + \Delta y) = \cos\left(\frac{\pi}{2} + \theta\right) = -\cos\left(\frac{\pi}{2} - \theta\right) = -\vec{N}(x_1, y) \cdot \vec{T}(x_1, y)$$

Since every point of  $(x, x + \Delta x)$  gives this result, we have  $\int_{C_2} \vec{N} \cdot \vec{T} ds + \int_{C_4} \vec{N} \cdot \vec{T} ds = 0$ , and so the line integral is equal to the line integral over the paths  $C_1$  and  $C_3$  i.e.

$$\begin{aligned} \oint_{\Gamma} \vec{N} \cdot \vec{T} ds &= \int_{C_1} \vec{N} \cdot \vec{T} ds + \int_{C_3} \vec{N} \cdot \vec{T} ds \\ &= \int_{C_1} f(x + \Delta x) ds + \int_{C_3} -f(x) ds \\ &= \frac{x + \Delta x}{t} \int_{C_1} ds - \frac{x}{t} \int_{C_3} ds \\ &= \left(\frac{x + \Delta x}{t} - \frac{x}{t}\right) \Delta y = \frac{\Delta x \Delta y}{t}. \end{aligned}$$

Then, if we multiply the line integral with the length of the tracer arm  $t$ , we get the area of the rectangle i.e.

$$t \oint_{\Gamma} \vec{N} \cdot \vec{T} ds = \Delta x \Delta y,$$

and also by the Green's theorem we have

$$t \oint_{\Gamma} \vec{N} \cdot \vec{T} ds = \int \int_R t(Q_x - P_y) dA.$$

Thus the integral  $\int \int_R t(Q_x - P_y) dA$  is the area of  $R$  whenever  $R$  is an axis parallel rectangle and the curl  $t(Q_x - P_y)$  of the vector field  $t\vec{N}(x, y)$  is 1. Indeed if there is a point  $(x', y')$  in the reachable region such that  $t(Q_x - P_y)(x', y') \neq 1$ , then without loss generality we can assume  $t(Q_x - P_y)(x', y') > 1$ . Since the function  $t(Q_x - P_y)(x, y)$  is continuous, we can choose a sufficiently small axis rectangle  $\Delta D$  around the point  $(x', y')$  so that over the neighborhood  $t(Q_x - P_y)(x, y) > 1$ . Then

$$\int \int_{\Delta D} t(Q_x - P_y) dA > \int \int_{\Delta D} 1 dA = \text{area of } \Delta D$$

which contradicts that  $\int \int_{\Delta D} t(Q_x - P_y) dA$  is the area of the region. Thus for any point of the reachable region the function value of  $t(Q_x - P_y)$  is equal to 1.

Finally this implies that the area of any simple closed region  $D$  in the reachable area is equal to the total wheel rolling along the boundary  $\Gamma$  of the region times the length of the tracer arm i.e.

$$t \oint_{\Gamma} \vec{N} \cdot \vec{T} ds = \int \int_D t(Q_x - P_y) dA = \int \int_D 1 dA = \text{area of } D.$$

## Chapter 5

### Explaining Planimeters by Green's Theorem With Evaluating Integrals

In this chapter, the working of the planimeters are explained by the direct use of the Green's Theorem.

#### 5.1 The Direct Use of Green's Theorem for the Polar Planimeter

In the  $xy$ -coordinate system, the pole point is fixed at the origin,  $OA$  and  $AB$  are the polar and tracer arms with lengths  $l$  and  $t$ , respectively.

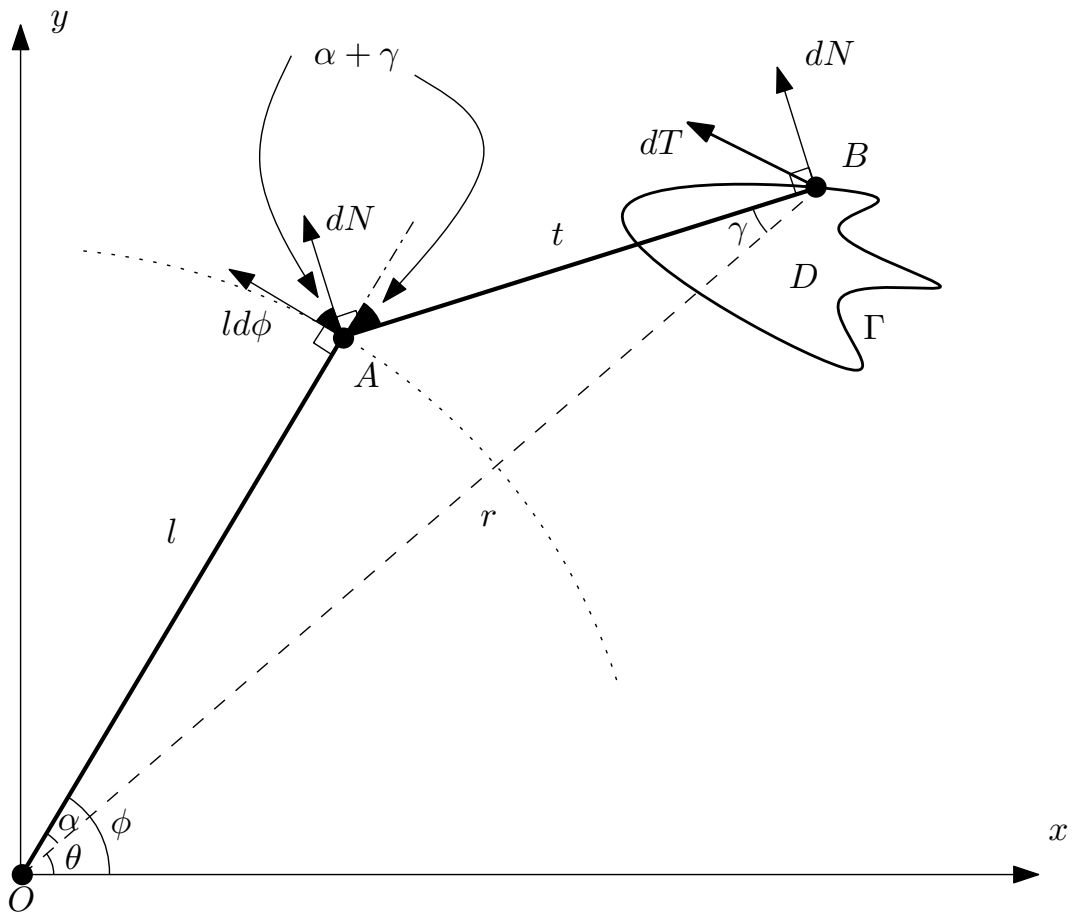

Figure 5.1 *The mechanics of the polar planimeter.*

The measuring wheel is attached to the tracer arm at  $A$  so that its axis is parallel to the tracer arm. We assume that the planimeter traces, by the tracer at  $B$ , the boundary  $\Gamma$  of a region  $D$  in a counterclockwise direction. The motion of the tracer forces the pivot to move on the circle with center  $O$  and radius  $l$ . Notice again that the wheel rolls only if the motion is not parallel to the axis of the wheel.

We are going to show that the total rolling of the measuring wheel times the length of the tracer arm is the area of a measured region  $D$ .

During the motion, the tracer arm has two elementary motions: translation and rotation. When the tracing is completed, the terminating position of the tracer arm is the same as the initial position so total rotation of the tracer arm is zero and the rotation does not affect the total rolling of the wheel. Therefore, we consider only the translation.

Consider Figure 5.1, which illustrates that the tracer starts to move at point  $(x, y)$  and takes a directed distance  $\Delta B$  on the curve  $\Gamma$ . Let  $\Delta N$  be a component of  $\Delta B$  perpendicular to the tracer arm, let  $\Delta\phi$  be the infinitesimal change of the angle  $\phi$ . The pivot covers a distance  $l\Delta\phi$  and the component  $\Delta N$  becomes equal to  $\cos(\alpha + \gamma)l\Delta\phi$ . During the motion, the rotation of tracer arm is equal to  $\Delta\beta$  but that is not changing the pivot's position so the wheel does not roll. Therefore for an infinitesimal travel  $\Delta B$  of the tracer, the wheel rotates  $\Delta N = \cos(\alpha + \beta)l\Delta\phi$ . Using a standard subdivision and limit argument we get

$$\text{Total wheel rolling} = \oint_{\Gamma} dN = \lim_{\Delta B \rightarrow 0} \int_{\Gamma} \cos(\alpha + \gamma)l\Delta\phi = \oint_{\Gamma} l\cos(\alpha + \gamma)d\phi$$

Here, we are going to write the component  $dN = P(x, y)dx + Q(x, y)dy$  and apply Green's theorem, i.e.

$$\oint_{\Gamma} dN = \oint_{\Gamma} P(x, y)dx + Q(x, y)dy = \int \int_D (Q_x - P_y)dA,$$

then show that

$$\int \int_D (Q_x - P_y)dA = \frac{1}{t} \int \int_D dA.$$

Let us find,  $P(x, y)$  and  $Q(x, y)$ . Since  $dN = \cos(\alpha + \gamma)ld\phi$  let us calculate  $\cos(\alpha + \gamma)$ , using one of the trigonometries identities.

$$\cos(\alpha + \gamma) = \cos(\alpha) \cos(\gamma) - \sin(\alpha) \sin(\gamma).$$

In view of Figure 5.1, from the triangle  $OAB$

$$l^2 = t^2 + r^2 - 2tr \cos \gamma$$

so  $\cos \gamma = \frac{t^2 + r^2 - l^2}{2tr}$

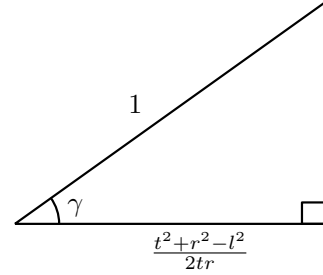

Also we can easily find

$$\begin{aligned} \sin \gamma &= \sqrt{1 - \left(\frac{t^2 + r^2 - l^2}{2tr}\right)^2} \\ &= \frac{\sqrt{-t^4 - r^4 - l^4 + 2t^2r^2 + 2t^2l^2 + 2r^2l^2}}{2tr}. \end{aligned}$$

Figure 5.2 *The computation of  $\sin \gamma$ .*

Similarly,

$$\cos \alpha = \frac{l^2 + r^2 - t^2}{2lr} \quad \text{and} \quad \sin \alpha = \frac{\sqrt{-t^4 - r^4 - l^4 + 2t^2r^2 + 2t^2l^2 + 2r^2l^2}}{2lr}.$$

Therefore,

$$\begin{aligned} \cos(\alpha + \gamma) &= \cos(\alpha) \cos(\gamma) - \sin(\alpha) \sin(\gamma) \\ &= \left(\frac{l^2 + r^2 - t^2}{2lr}\right) \left(\frac{t^2 + r^2 - l^2}{2tr}\right) \\ &\quad - \left(\frac{\sqrt{-t^4 - r^4 - l^4 + 2t^2r^2 + 2t^2l^2 + 2r^2l^2}}{2lr}\right) \left(\frac{\sqrt{-t^4 - r^4 - l^4 + 2t^2r^2 + 2t^2l^2 + 2r^2l^2}}{2tr}\right) \\ &= \frac{r^4 - l^4 - t^4 + 2l^2t^2}{4r^2lt} - \frac{-t^4 - r^4 - l^4 + 2t^2r^2 + 2t^2l^2 + 2r^2l^2}{4r^2tl} \\ &= \frac{r^2 - t^2 - l^2}{2tl}. \end{aligned}$$



To compute  $d\phi$ , (Figure 5.1), since

$$r^2 = x^2 + y^2$$

and

$$\tan \theta = \frac{y}{x} \Rightarrow \theta = \tan^{-1}\left(\frac{y}{x}\right)$$

so we have

$$dr = \frac{x}{r}dx + \frac{y}{r}dy$$

and

$$d\theta = -\frac{y}{r^2}dx + \frac{x}{r^2}dy$$

Since  $\cos \alpha = \frac{t^2 + r^2 - l^2}{2tr}$ , the angle  $\alpha = \cos^{-1}\left(\frac{t^2 + r^2 - l^2}{2tr}\right)$ .

Then,  $\phi = \theta + \alpha = \theta + \cos^{-1}\left(\frac{t^2 + r^2 - l^2}{2tr}\right)$ , and consequently

$$d\phi = d\theta + d\alpha = d\theta + \frac{-(r^2 - l^2 + t^2)}{r\sqrt{-t^4 - r^4 - l^4 + 2t^2r^2 + 2t^2l^2 + 2r^2l^2}}dr.$$

If we write  $dr$  and  $d\theta$  in the above formula, we get

$$\begin{aligned} d\phi &= d\theta + \frac{-(r^2 - l^2 + t^2)}{r\sqrt{-t^4 - r^4 - l^4 + 2t^2r^2 + 2t^2l^2 + 2r^2l^2}}dr \\ &= \left(-\frac{y}{r^2}dx + \frac{x}{r^2}dy\right) + \frac{-(r^2 - l^2 + t^2)}{r\sqrt{-t^4 - r^4 - l^4 + 2t^2r^2 + 2t^2l^2 + 2r^2l^2}}\left(\frac{x}{r}dx + \frac{y}{r}dy\right) \\ &= \left(-\frac{y}{r^2} + \frac{-x(r^2 - l^2 + t^2)}{r^2\sqrt{-t^4 - r^4 - l^4 + 2t^2r^2 + 2t^2l^2 + 2r^2l^2}}\right)dx \\ &\quad + \left(\frac{x}{r^2} + \frac{-y(r^2 - l^2 + t^2)}{r^2\sqrt{-t^4 - r^4 - l^4 + 2t^2r^2 + 2t^2l^2 + 2r^2l^2}}\right)dy. \end{aligned}$$

Therefore we obtained  $d\phi$  and  $\cos(\alpha + \gamma)$ , and substitutes these values in  $dN = l\cos(\alpha + \gamma)d\phi$  we get

$$\begin{aligned}
dN &= l\cos(\alpha + \gamma)d\phi \\
&= l \left( \frac{r^2 - t^2 - l^2}{2tl} \right) \left( -\frac{y}{r^2} + \frac{-x(r^2 - l^2 + t^2)}{r^2\sqrt{-t^4 - r^4 - l^4 + 2t^2r^2 + 2t^2l^2 + 2r^2l^2}} \right) dx \\
&+ l \left( \frac{r^2 - t^2 - l^2}{2tl} \right) \left( \frac{x}{r^2} + \frac{-y(r^2 - l^2 + t^2)}{r^2\sqrt{-t^4 - r^4 - l^4 + 2t^2r^2 + 2t^2l^2 + 2r^2l^2}} \right) dy \\
&= \left( \frac{-x(r^2 - t^2 - l^2)(r^2 - l^2 + t^2)}{tr\sqrt{-t^4 - r^4 - l^4 + 2t^2r^2 + 2t^2l^2 + 2r^2l^2}} - \frac{y}{2t} + \frac{y(t^2 + l^2)}{r^2t} \right) dx \\
&+ \left( \frac{-y(r^2 - t^2 - l^2)(r^2 - l^2 + t^2)}{tr\sqrt{-t^4 - r^4 - l^4 + 2t^2r^2 + 2t^2l^2 + 2r^2l^2}} + \frac{x}{2t} - \frac{x(t^2 + l^2)}{r^2t} \right) dy \\
&= P(x, y)dx + Q(x, y)dy.
\end{aligned}$$

When  $f(r)$  is a differentiable function of  $r$  then for the partial derivative of  $f$  we have

$$y \frac{\partial f}{\partial x} = y \frac{\partial f}{\partial r} \frac{\partial r}{\partial x} = y \frac{\partial f}{\partial r} \frac{x}{r} = x \frac{\partial f}{\partial r} \frac{y}{r} = x \frac{\partial f}{\partial r} \frac{\partial r}{\partial y} = x \frac{\partial f}{\partial y}$$

Since  $f(r) = \frac{-(r^2 - t^2 - l^2)(r^2 - l^2 + t^2)}{tr\sqrt{-t^4 - r^4 - l^4 + 2t^2r^2 + 2t^2l^2 + 2r^2l^2}}$  is a differentiable function of  $r$  then

$$y \frac{\partial f}{\partial x} = x \frac{\partial f}{\partial y}$$

and also direct calculation shows that

$$\frac{\partial}{\partial y} \left( \frac{y(t^2 + l^2)}{r^2t} \right) = \frac{(x^2 - y^2)(t^2 + r^2)}{r^4} \frac{1}{t} = \frac{\partial}{\partial x} \left( -\frac{x(t^2 + l^2)}{r^2t} \right).$$

On applying the Green's theorem to the total rolling of the wheel, we get

$$\begin{aligned} \oint_{\Gamma} dN &= \oint_{\Gamma} P(x, y)dx + Q(x, y) = \iint_D (Q_x - P_y)dA \\ &= \iint_D \frac{1}{2t} - \left(-\frac{1}{2t}\right)dA = \iint_D \frac{1}{t}dA. \end{aligned}$$

Therefore total rolling times the length of the tracer arm is the area of the region  $D$ , that is

$$t \oint_{\Gamma} dN = \iint_D dA = \text{area of } D.$$

## 5.2 The Direct Use of Green's Theorem for the Linear Planimeter

In the  $xy$ -coordinate system, let the  $y$ -axis be as the tracer line and  $AB$  as the tracer arm with length  $t$ . The measuring wheel is attached at a distance  $l$  from the pivot.

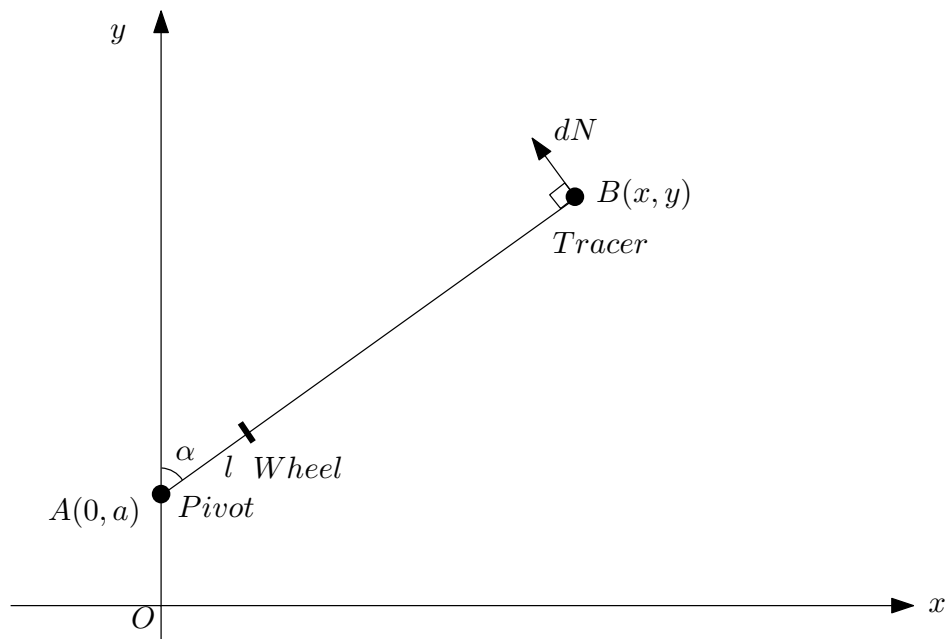

Figure 5.3 *The mechanics of the linear planimeter.*

We are going to show, as it was done for polar planimeter, that the total rolling of the wheel times the length of the tracer arm is the area of a measured region.

Every motion of the tracer can be replaced by a sequence of translations and rotations of the arm. So an infinitesimal motion  $\Delta B$  of the tracer on the boundary  $\Gamma$  is the same as infinitesimal parallel shifting  $\Delta a$  and rotation  $\Delta\theta$ .

At a rotation, the pivot does not change place, just the arm turns an angle  $\Delta\theta$  on the pivot and at a translation the arm moves parallelly by a distance  $\Delta a$ , so the pivot's new coordinates are  $(0, a + \Delta a)$ . The components of the motions, which are perpendicular to the arm, causes the rolling of the wheel. Therefore, since the rotation is perpendicular to the arm it also affect the rolling, i.e. the wheel rolls a distance  $l\Delta\theta$  plus  $\sin\alpha\Delta a$ . By the standard subdivision and limit argument we have

$$\text{Total rolling} = \oint_{\Gamma} dN = \lim_{\Delta B \rightarrow 0} \sin\alpha\Delta a + l\Delta\theta = \oint_{\Gamma} \sin\alpha da + \oint_{\Gamma} ld\theta$$

After tracing the curve  $\Gamma$ , the tracer arm returns to its initial position, so the rotation of the arm equals to zero and as it seen in the Figure 5.2 we have  $\sin\alpha = \frac{x}{t}$ , and so

$$\text{Total rolling} = \oint_{\Gamma} dN = \oint_{\Gamma} \sin\alpha da = \frac{1}{t} \oint_{\Gamma} x da. \quad (*)$$

To compute  $da$ , we have in Figure 5.2,

$$t^2 = x^2 + (y - a)^2$$

Because of the initial assumptions of the linear planimeter, the tracer arm cannot rotate past the roller, thus we have  $a < y$  and so  $a$  has an unique value for each point  $(x, y)$  of the curve. Then

$$a = y - \sqrt{t^2 - x^2}$$

so  $da = dy + \frac{x}{\sqrt{t^2 - x^2}} dx,$

and substituting this expression in the (\*) we get

$$\begin{aligned}
 \frac{1}{t} \oint_{\Gamma} x da &= \frac{1}{t} \oint_{\Gamma} x \left( dy + \frac{x}{\sqrt{t^2 - x^2}} dx \right) \\
 &= \frac{1}{t} \oint_{\Gamma} \frac{x^2}{\sqrt{t^2 - x^2}} dx + x dy \\
 &= \frac{1}{t} \oint_{\Gamma} P(x, y) dx + Q(x, y) dy.
 \end{aligned}$$

Now, by taking the partial derivatives of  $P(x, y)$  and  $Q(x, y)$  with to  $y$  and  $x$ , we have,

$$P_y = 0 \quad \text{and} \quad Q_x = 1,$$

and this on applying Green's theorem gives

$$\begin{aligned}
 \text{Total rolling} &= \oint_{\Gamma} dN = \frac{1}{t} \iint_D (Q_x - P_y) dA \\
 &= \frac{1}{t} \iint_D dA.
 \end{aligned}$$

Therefore, the computation shows that total rolling times the arm length is the area of the measured area i.e.

$$t \oint_{\Gamma} dN = \text{area of } D.$$

## Bibliography

- [1] Ronald W. Gatterdam, "The Planimeter as an Example of Green's Theorem", *Mathematical Association of America*, 88 (Nov, 1981), pp. 701-704.
- [2] Henrici, O." Report on Planimeters", *British Assoc.*, Report of the 64th meeting, 1984, pp. 496-523.
- [3] Leise, T. "As the Planimeter's Wheel Turns: Planimeter Proofs for calculus Class", *The College Mathematics Journal* 38, 1, Jan. 2007, pp. 24-31.
- [4] Casselman, B. and Eggers, J., "The Mathematics of Surveying: PartII. The Planimeter", *American Mathematical Society Feature Column*, Jun-Jul. 2008.
- [5] Foote L. R., "Geometry Of The Prytz Planimeter", *Reports on Mathematical Physics*, 42 Jun. 2, 1998 pp. 249-271.
- [6] Lowell L. I. "Comments on the Polar Planimeter", *Mathematical Association of America*, 61, 7 (Aug.-Sep. 1954) pp.467-469.
- [7] Devadoss S. L. and O'Rourke J. "Discrete and Computation Geometry", *Princeton University Press*, 2011.
- [8] Knill O. Winter D. "Green's Theorem and the Planimeter", *Web document: <https://www.math.duke.edu//education/ccp/materials/mvcalc/green/>*, Nov. 15, 2002.