

**Repressible Transgenic Sterilization in Channel Catfish, *Ictalurus punctatus*,  
by Knockdown of Primordial Germ Cell Genes**

by

Hanbo Li

A dissertation submitted to the Graduate Faculty of  
Auburn University  
in partial fulfillment of the  
requirements for the Degree of  
Doctor of Philosophy

Auburn, Alabama  
Aug 6, 2016

Keywords: transgenic sterilization, channel catfish, PGC marker genes expression

Copyright 2016 by Hanbo Li

Approved by

Rex A. Dunham, Chair, Professor of Fisheries and Allied Aquacultures  
Charles Chen, Associate Professor of Crop, Soil and Environmental Sciences  
Jesse Chappell, Associate Professor of Fisheries and Allied Aquacultures  
Joanna Diller, Associate Professor of Biological Sciences

## Abstract

Genetic engineering has great potential for development of fish with higher growth rate, better disease resistance and increased nutritional value. However, genetically modified animals could pose ecological risk to the environment upon escapement, and fail-safe confinement needs to be developed to minimize this risk. Knockdown approaches utilizing overexpression and shRNAi approaches were investigated to attempt repressible transgenic sterilization in channel catfish, *Ictalurus punctatus*. Two primordial germ cell marker genes, *nanos* and *dead end* were targeted for knockdown and an off-target gene, *vasa*, was monitored. Their expression was evaluated at 3 time points during embryonic development using real-time PCR. Seven potentially repressible promoters, zebrafish *Adss2* and *racemase* (sodium chloride), yeast *ctr3* and *ctr3*-reduced (copper sulfate), channel catfish *nanos* and *vasa* coupled with a Tet-off system and salmon *transferrin* (cadmium chloride) were each coupled with 4 knockdown strategies including: (1) a ds-sh RNA targeting the 5' end of channel catfish *nanos* gene (N1), (2) a ds-sh RNA targeting the 3' end of channel catfish *nanos* gene (N2), (3) a full length cDNA sequence of channel catfish *nanos* gene to overexpress *nanos* (cDNA) and (4) a ds-sh RNA targeting channel catfish *dead end* gene (dnd). Except for the *nanos* cDNA sequence, all constructs have a short hairpin structure and double stranded RNA to produce 28 different constructs for evaluation as repressible transgenic sterilization systems. Each construct was divided into two groups: untreated group and treated group with sodium chloride, cadmium chloride, copper sulfate or doxycycline as repressor compounds. Constructs were electroporated into embryos to produce the P1 generation and artificial spawning used to make the F1 and F2 generations.

For most systems and gene constructs, rates of P1 fish exposed to the constructs as embryos spawning full-siblings, 88% and 56%, respectively, indicating potential sterilization and repression of the constructs. In F1 fish, mRNA expression levels of PGC marker genes for most of constructs were significantly down regulated in untreated group and the knockdown was repressed in treated group. The downregulation in the F1 transgenic untreated embryos was sometimes similar, but often greater than what was observed in their parents (Su 2012, Su et al. 2015) that were exposed to the constructs via electroporation the previous generation. The repression was also more effective in treated F1 embryos than for the P1. In three F2 families that were produced, knockdown and repression for the constructs TDND and McDNA were similar as the same constructs in the F1, but the treated ADSSN2 embryos had strong upregulation rather than repression of the Adss promoter. Constructs with the knockdown strategies N2 and cDNA were the most effective for knockdown of primordial germ cell genes, and the promoters, ADSS, Mctr and M were the most responsive to the chemicals applied for repression. When considering the combination of knockdown and repression, the constructs ADSSN2, MctrN2 and McDNA showed the most potential as repressible transgenic sterilization systems. Gonad development in transgenic untreated F1 channel catfish was significantly reduced compared to non-transgenic fish for MctrN2, MN1, MN2, MDND and TDND. For 3-year-old adults, gonad size in the transgenic untreated group was 93.4% smaller than the non-transgenic group for females, and 92.3% for males. However, body size of transgenic females (782g) and males (884g) were smaller than non-transgenic counterparts (984g and 1254g) at three years of age, a 25.8% and 41.9% difference for females and males, respectively. This negative pleiotropic effect would negate the usefulness of the repressible transgenic sterilization unless this growth reduction is more than compensated for by insertion of growth related transgenes.

## Acknowledgment

The author would like to thank all the undergraduate students in Dr. Dunham's group who worked as a team during spawning seasons and performed the hard work of harvesting ponds and feeding the brood fish. Without the kind help from Zhi Ye, William Bugg, Kamal Gosh, Ahmed Elaswad, David Drescher, Ramjie Odin, Nathan Backenstose and Dalton Rabinson, fieldwork and experiments could not go smoothly and successfully.

I would give credit to Guyu Qin, Zhenqui Qin and Chia-Chen Weng Chen for all the assistance in the lab and greenhouse, Dr. Baofeng Su for all the help and suggestions in early period of this project.

I would thank my committee members, Dr. Joanna Diller, Dr. Jesse Chappell and Dr. Charles Chen for all the suggestions and guidance for the my research and dissertation writing. Special thanks to Dr. Anthony Moss for helped review and revise my dissertation.

The author was partially sponsored by a 4-year scholarship from Chinese Scholarship Council (CSC).

Finally, I would thank Dr. Rex Dunham for all the supports from you these years, you are the best major professor.

## Table of Contents

Abstract.....	ii
Acknowledgement.....	iv
List of Tables.....	vi
List of Figures.....	vii
I.     Repressible Transgenic Sterilization in Channel Catfish <i>Ictalurus punctatus</i>	
Introduction.....	1
Materials and methods.....	7
Results .....	15
Discussion.....	52
Conclusions.....	57
References.....	59

## List of Tables

Table 1 Gonadal somatic index, GSI of 1-year-old and 3-year-old transgenic and non-transgenic full-sibling channel catfish, <i>Ictalurus punctatus</i> , grown in a 0.04-ha pond.....	42
Table 2 Body weight of 1-year-old and 3-year-old transgenic and non-transgenic full-sibling channel catfish, <i>Ictalurus punctatus</i> , grown in a 0.04-ha pond.....	47
Table 3 Spawning rates of P1 female channel catfish ( <i>Ictalurus punctatus</i> ) electroporated with constructs designed to disrupt primordial germ cell migration and then either untreated and treated with compounds expected to repress the expression of the transgene.....	50
Table 4 spawning rates of P1 female channel catfish ( <i>Ictalurus punctatus</i> ) electroporated with constructs designed to disrupt primordial germ cell migration and then either untreated or treated with compounds expected to repress the expression of the transgene. Groups are pooled by 7 promoters and 4 knock down strategies.....	51

## List of Figures

Fig.1. Mechanism of the modified tet-off system .....	5
Fig.2. An example of a simplified tet-off like system, Cadmium sensitized salmon transferrin gene is used as promoter .....	6
Fig.3. Primordial germ cell knockdown constructs for the sterilization of channel catfish, <i>Ictalurus punctatus</i> .....	9
Fig.4. Primordial germ cell knockdown sequences for channel catfish, <i>Ictalurus punctatus</i> .....	9
Fig.5. Seven promoters paired with 4 knockdown strategies resulting in 28 sterilization constructs for the knockdown of <i>nanos</i> and <i>deadend</i> in channel catfish, <i>Ictalurus punctatus</i> .....	10
Fig.6. Expression of relative primordial germ cell (PGC) marker genes, <i>nanos</i> , <i>vasa</i> , and <i>dead end (dnd)</i> in non-transgenic channel catfish ( <i>Ictalurus punctatus</i> ) embryos. ....	15
Fig.7. Expression of relative primordial germ cell (PGC) marker genes, <i>nanos</i> , <i>vasa</i> , and <i>dead end (dnd)</i> in the treated and untreated zebrafish <i>racemase</i> gene (RM) promoter fused with 5' end shRNAi targeting channel catfish <i>nanos</i> (N1) F1 transgenic RMN1 channel catfish ( <i>Ictalurus punctatus</i> ) embryos.....	17
Fig.8. Expression of relative primordial germ cell (PGC) marker genes, <i>nanos</i> , <i>vasa</i> , and <i>dead end (dnd)</i> in the treated and untreated yeast <i>mctr3</i> gene (M) promoter fused with 5' end shRNAi targeting channel catfish <i>nanos</i> gene (N1) F1 MN1 transgenic channel catfish ( <i>Ictalurus punctatus</i> ) embryos.....	19
Fig.9. Expression of relative primordial germ cell (PGC) marker genes, <i>nanos</i> , <i>vasa</i> , and <i>dead end (dnd)</i> in untreated yeast <i>mctr3</i> -reduced gene (Mctr) promoter fused with 5' end shRNAi targeting channel catfish <i>nanos</i> gene (N1) F1 MctrN1 transgenic channel catfish ( <i>Ictalurus punctatus</i> ) embryos.....	20
Fig.10. Expression of relative primordial germ cell (PGC) marker genes, <i>nanos</i> , <i>vasa</i> , and <i>dead end (dnd)</i> in treated and untreated zebrafish <i>adss2</i> gene (Adss) promoter fused with 3' end shRNAi targeting channel catfish <i>nanos</i> gene (N2) F1 AdssN2 transgenic channel catfish ( <i>Ictalurus punctatus</i> ) embryos.....	23

- Fig.11. Expression of relative primordial germ cell (PGC) marker genes, *nanos*, *vasa*, and *dead end (dnd)* in zebrafish *racemase* gene (RM) promoter fused with 3' end shRNAi targeting channel catfish *nanos* gene (N2) F1 RMN2 transgenic channel catfish (*Ictalurus punctatus*) embryos.....24
- Fig.12. Expression of relative primordial germ cell (PGC) marker genes, *nanos*, *vasa*, and *dead end (dnd)* in yeast *mctr3* gene (M) promoter fused with 3' end shRNAi targeting channel catfish *nanos* gene (N2) F1 MN2 transgenic channel catfish (*Ictalurus punctatus*) embryos.....26
- Fig.13. Expression of relative primordial germ cell (PGC) marker genes, *nanos*, *vasa*, and *dead end (dnd)* in treated and untreated yeast *mctr3*-reduced gene (Mctr) promoter fused with 3' end shRNAi targeting channel catfish *nanos* gene (N2) F1 MctrN2 transgenic channel catfish (*Ictalurus punctatus*) embryos.....27
- Fig.14. Expression of relative primordial germ cell (PGC) marker genes, *nanos*, *vasa*, and *dead end (dnd)* in treated and untreated salmon *transferrin* gene (T) promoter fused with 3' end shRNAi targeting channel catfish *nanos* gene (N2) F1 TN2 transgenic channel catfish (*Ictalurus punctatus*) embryos.....29
- Fig.15. Expression of relative primordial germ cell (PGC) marker genes, *nanos*, *vasa*, and *dead end (dnd)* in treated and untreated channel catfish *nanos* gene (Nanos) promoter fused with 3' end shRNAi targeting channel catfish *nanos* gene (N2) F1 NanosN2 transgenic channel catfish (*Ictalurus punctatus*) embryos.....29
- Fig.16. Expression of relative primordial germ cell (PGC) marker genes, *nanos*, *vasa*, and *dead end (dnd)* in treated and untreated zebrafish *adss2* gene (Adss) promoter fused with cDNA of channel catfish *nanos* gene (cDNA) F1 AdsscDNA transgenic channel catfish (*Ictalurus punctatus*) embryos.....31
- Fig.17. Expression of relative primordial germ cell (PGC) marker genes, *nanos*, *vasa*, and *dead end (dnd)* in treated and untreated zebrafish *racemase* gene (RM) promoter fused with cDNA of channel catfish *nanos* gene (cDNA) F1 RMcDNA transgenic channel catfish (*Ictalurus punctatus*) embryos.....32
- Fig.18. Expression of relative primordial germ cell (PGC) marker genes, *nanos*, *vasa*, and *dead end (dnd)* in treated and untreated yeast *mctr3* gene (M) promoter fused with cDNA of channel catfish *nanos* gene (cDNA) F1 McDNA transgenic channel catfish (*Ictalurus punctatus*) embryos.....33
- Fig.19. Expression of relative primordial germ cell (PGC) marker genes, *nanos*, *vasa*, and *dead end (dnd)* in treated and untreated yeast *transferrin* gene (T) promoter fused with cDNA of channel catfish *nanos* gene (cDNA) F1 TcDNA transgenic channel catfish (*Ictalurus punctatus*) embryos.....33



- Fig.20. Expression of relative primordial germ cell (PGC) marker genes, *nanos*, *vasa*, and *dead end (dnd)* in treated and untreated zebrafish *adss2* gene (Adss) promoter fused with shRNAi targeting channel catfish *dead end* gene (DND) F1 AdssDND transgenic channel catfish (*Ictalurus punctatus*) embryos.....35
- Fig.21. Expression of relative primordial germ cell (PGC) marker genes, *nanos*, *vasa*, and *dead end (dnd)* in treated and untreated yeast *mctr3* gene (M) promoter fused with shRNAi targeting channel catfish *dead end* gene (DND) F1 MDND transgenic channel catfish (*Ictalurus punctatus*) embryos.....36
- Fig.22. Expression of relative primordial germ cell (PGC) marker genes, *nanos*, *vasa*, and *dead end (dnd)* in treated and untreated salmon *transferrin* gene (T) promoter fused with shRNAi targeting channel catfish *dead end* gene (DND) F1 TDND transgenic channel catfish (*Ictalurus punctatus*) embryos.....36
- Fig.23. Expression of relative primordial germ cell (PGC) marker genes, *nanos*, *vasa*, and *dead end (dnd)* in treated and untreated channel catfish *vasa* gene (Vasa) promoter fused with shRNAi targeting channel catfish *dead end* gene (DND) F1 VasaDND transgenic channel catfish (*Ictalurus punctatus*) embryos.....37
- Fig.24. Expression of relative primordial germ cell (PGC) marker genes, *nanos*, *vasa*, and *dead end (dnd)* in treated and untreated zebrafish *adss2* gene (Adss) promoter fused with 3' end shRNAi targeting channel catfish *nanos* gene (N2) F2 AdssN2 transgenic channel catfish (*Ictalurus punctatus*) embryos.....39
- Fig.25. Expression of relative primordial germ cell (PGC) marker genes, *nanos*, *vasa*, and *dead end (dnd)* in treated and untreated salmon *transferrin* gene (T) promoter fused with shRNAi targeting channel catfish *dead end* gene (DND) F2 TDND transgenic channel catfish (*Ictalurus punctatus*) embryos.....39
- Fig.26. Expression of relative primordial germ cell (PGC) marker genes, *nanos*, *vasa*, and *dead end (dnd)* in treated and untreated yeast *mctr3* gene (M) promoter fused with cDNA of channel catfish *nanos* gene (cDNA) F2 McDNA transgenic channel catfish (*Ictalurus punctatus*) embryos.....40
- Fig.27. Distribution of gonadal somatic index, GSI (= gonad weight/body weight x100) of 1-year-old male (a) and female (b) transgenic and non-transgenic full-sibling channel catfish, *Ictalurus punctatus*,.....43
- Fig.28. Distribution of gonadal somatic index, GSI (= gonad weight/body weight x100) of 3-year-old male (a) and female (b) transgenic and non-transgenic full-sibling channel catfish, *Ictalurus punctatus*, grown in a 0.04-ha pond.....45

# **Repressible Transgenic Sterilization in Channel Catfish, *Ictalurus punctatus***

## **1. Introduction**

The channel catfish (*Ictalurus punctatus*) is an important food fish species in the United States. The production of catfish peaked at 300 million kg in 2003, and then contracted to 226, 127 and 138 million kg in 2007, 2008 and 2011, respectively (NASS 2012; NRC 2002), and has been fairly constant recently at 150 million kg (Hanson and Sites 2015). The factors that caused the decline of the U.S. catfish industry included intense competition from imported products from Asia, and increased feed and fuel costs. Despite this, catfish production is still the most important sector of U.S. food fish aquaculture, valued at around \$423 million in 2012, and with multiplier effects, which are large in the catfish industry; the economic impact of the catfish industry is \$2.5 billion.

Catfish farming appears very profitable for farms that survived this decline; however, foreign imports now have more than 50% of the catfish market in the US. If US farmers do not become more efficient, they could become susceptible during the next economic down turn or if fuel and feed costs rise again. Improving efficiency and recapturing food fish market share would have large economic implications for the US and rural communities as well as contributing to US food security, and could restore the catfish industry to its peak production levels or more.

Genetically enhanced catfish such as hybrid catfish can have traits improved in specific aspects; however, potential maximum improvement in overall performance is not close to being achieved (Dunham et al. 2002). Genetically engineered catfish have great potential for higher growth rate, better disease resistance and increased nutritional value (Dunham et al. 1995), and might help provide greater sustainability and profitability for US catfish industry. Previous experiments have shown that transgenic channel catfish containing salmonid growth hormone genes can grow 33% faster than normal channel catfish under aquaculture conditions (Dunham et al. 1995). Transgenic individuals containing preprocecropin B construct had 2.5-4.0X greater survivals than nontransgenic controls when exposed to

pathogenic bacteria (Dunham et al. 2002). P1 transgenic salmon desaturase common carp had 7.2% higher n-3 fatty acids in their muscle compared to the control (Cheng et al. 2013). The production of transgenic fish would likely have lower culture costs, potential to be altered for better nutritional content, and could also be of improved value for consumers. Most importantly, the transgenic technology provides great potential to better traits for target species.

A major concern regarding the use of transgenic fish is potential ecological impact from escapees or released individuals on natural populations (Rasmussen et al. 2007; Devlin et al. 2015). To minimize environmental risk, all transgenic organisms must be protected against escape both physically and genetically.

While physical confinement is an option to prevent escape, it has inherent deficiencies when careless operational mistakes or damage from weather events may lead to escape of transgenic animals, from aquaculture systems to the natural environment (Mair et al. 2007). Theft is another very real possibility. Physical confinement cannot guarantee that transgenes will never establish in the wild. Genetically engineered repressible transgenic sterilization is one of the best options to ensure that transgenic fish cannot permanently establish themselves in ecosystems.

One option for development of repressible transgenic sterilization involves control of primordial germ cells (PGCs), the embryonic precursors of the gametes. Because the origin of PGCs is far from the developmental site of the gonads, they must migrate to the embryo's genital ridge (Molyneaux et al. 2004). In zebrafish, a number of genetic markers are associated with PGCs proper migration, such as *vasa*, *nanos(nos)*, *askopos*, *dead end* and *dazl*. Knock out of those markers genes can prevent or disrupt the migration of PGCs. Prevention of PGC migration invariably produces sterile fish.

In *Drosophila*, *nanos* is expressed in the early germarium where it is needed for continued egg chamber production, or in mature eggs and the developing zygote it is also required to specify posterior identity. *Nanos* encoded protein can bind to 3' UTR of *hunchback* and *bicoid* mRNA and inhibit their translation (Murata 1995). In zebrafish, *nanos* (or *nos*) is essential for proper migration and survival of PGCs

(Köprunner et al. 2001; Molyneaux et al. 2004). Although the formation of PGCs does not require *nanos* activity, PGCs with *nanos* deficiency demonstrate abnormal conditions such as lack of colonization in the gonad, premature activation of germ cell markers, abnormal morphology, and expression of mRNAs that are normally expressed in the soma. The expression period of *nanos* is relatively shorter than *vasa*, and the mRNA signal can be undetectable after the fifth day of embryonic development.

*Vasa* is an RNA binding protein with an RNA dependent helicase. *Vasa* is a unique PGC marker because of its long-term and continual expression in the germ line (Fan et al. 2008; Molyneaux et al. 2004; Yoon et al 1997). As a PGC marker, the role and functions of *vasa* are not as conserved as other markers. *Vasa* may have evolved to have different functions in different species, which may explain its longer duration of expression compared to other PGC markers (Saito et al. 2006; Herpin et al. 2007). In zebrafish, *vasa* encodes an RNA helicase, and is essential for the assembly of the germ plasm and the migration of PGCs (Braat et al. 2001). Another function of *vasa* is to overcome the repressive effect of *nanos* translational control element, an evolutionarily conserved dual stem-loop structure in the 3' UTR which acts independently of the localization signal to repress translation of *nanos* mRNA (Gavis et al, 1996).

*Dead end* protein is a RNA-binding factor that positively regulates gene expression by prohibiting miRNA-mediated gene suppression, it relieves miRNA repression in germline cells. *Dead end* is the first factor found to play a specific role in the initiation of PGC mobility. Knockdown of *dead end* terminates dorsal movement of PGCs within the deep blastoderm, which is the initial migration step of PGCs (Weidinger et al. 2003). PGCs will die eventually without migration, but the death has no effect on somatic development. If *nanos* and *vasa* along with other markers are normally expressed, even with *dead end* knocked out and primary PGC migration stopped or inhibited, the secondary effect of PGC specification will not be influenced. Both markers will disappear after the death of PGCs (Weidinger et al. 2003).

RNA interference (RNAi) is frequently used in molecular biotechnology to inhibit

gene expression, different strategies such as double-stranded RNA (dsRNA), short hairpin RNA (shRNA), micro RNA (miRNA) and small interfering RNA (siRNA) can be applied to achieve the goal (Saurabh et al. 2014). When exogenous RNA, which is synthesized with a sequence complementary to a gene of interest, is expressed *in vivo*, and the RNAi pathway activated, the target gene is silenced (Daneshmandi 2007).

Ds-shRNA constructs contain a DNA sequence complementary to the target gene. After transcription, the dsRNA product initiates RNAi by activating the ribonuclease protein Dicer, which binds and cleaves dsRNAs into double-stranded fragments of siRNA. Antisense strands from unwound siRNA called guide strand is not degraded, but incorporated into the RNA-induced silencing complex (RISC) and complementarily pairs with the target mRNA to cleave it. Argonaute protein, the catalytic component of the RISC complex, executes the induced cleavage (Daneshmandi 2007). miRNAs endogenously induced gene silencing effects as well as silencing triggered by foreign dsRNA. Mature miRNAs are structurally similar to siRNAs produced from exogenous dsRNA, but expressed from much longer RNA-coding genes as a primary transcript known as pri-miRNAs. Pri-mRNAs is processed to pre-miRNAs by the microprocessor complex. The dsRNA portion of this pre-miRNA is bound and cleaved by Dicer to produce the mature miRNA molecule that can be integrated into the RISC complex (Gregory et al. 2006).

Another option is overexpression of a target gene via full-length cDNA, which should trigger feedback loop or have undesired malicious effects, leading to gene knockdown or knockout (Fire et al. 1997). Function of the bone morphogenetic protein 2 (BMP-2) gene in zebrafish, common carp and channel catfish has been successfully disrupted using the cDNA overexpression approach (Thresher et al. 2009;). Overexpression could complement loss-of-function screens, and has dominant effects (Prelich 2012).

RNAi is an important component of Sterile Feral (SF) technology, a modified Tet-off system (Fig.1)(Thresher et al. 2005, 2009) and this system has been demonstrated to work as a transgenic sterilization system. However, the repressors used in the SF system, tetracycline and doxycycline, are expensive in large-scale use and also environmentally problematic. Additionally, these transgenes contain small

viral sequences, which might be found out by competitors from public record and spread the information that negatively perceived by consumers. Alternative, environmentally friendly, and efficient Tet-off-like systems are needed. Thus, promoters that can be repressed by non-antibiotic chemicals are needed in the new system (Fig.2).

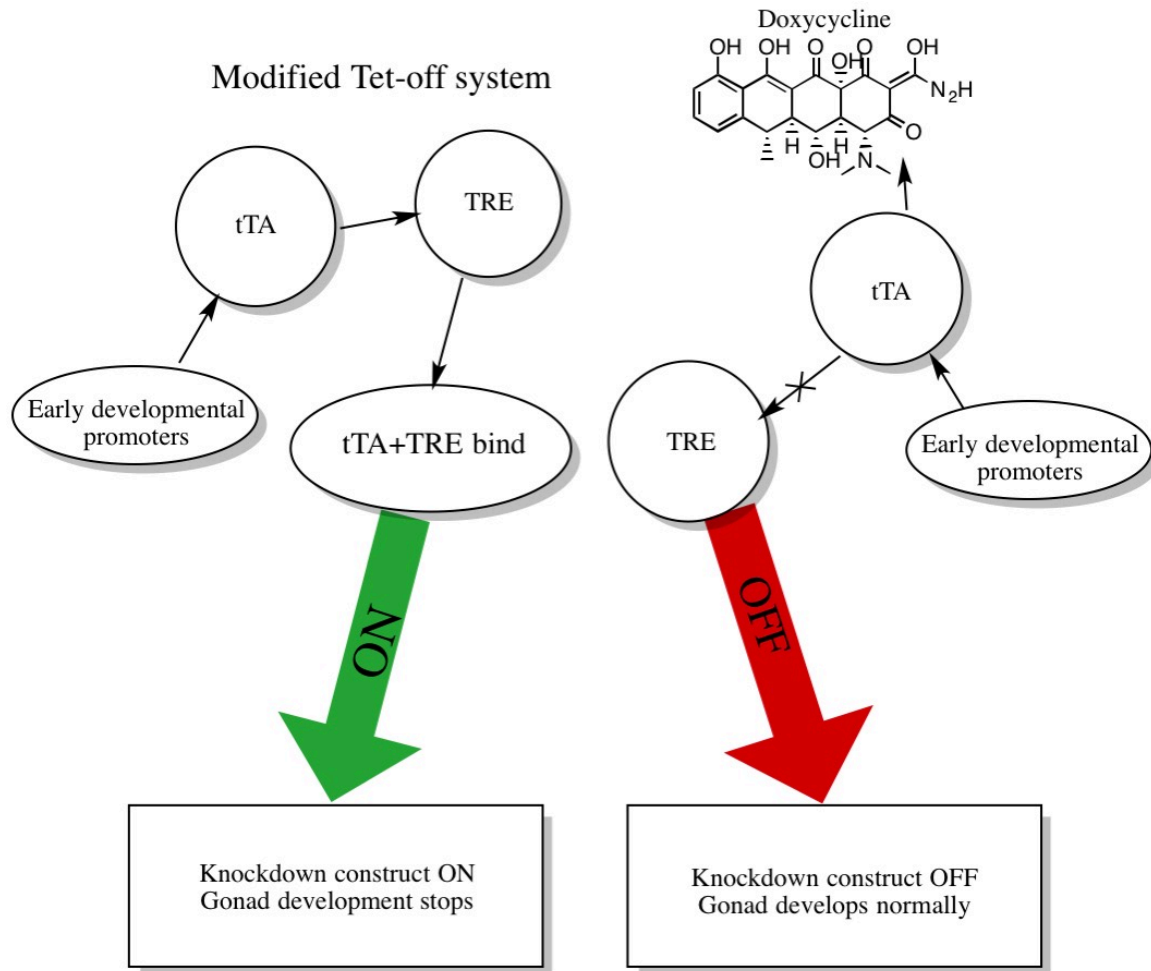

Figure 1. Mechanism of the modified Tet-off system. RNAi is a perfect component for this system to execute target gene knockdown. In this system, tetracycline or doxycycline is necessary to competitively bind with tTA in order to prevent the tTA-TRE complex from turning on the knockdown construct.

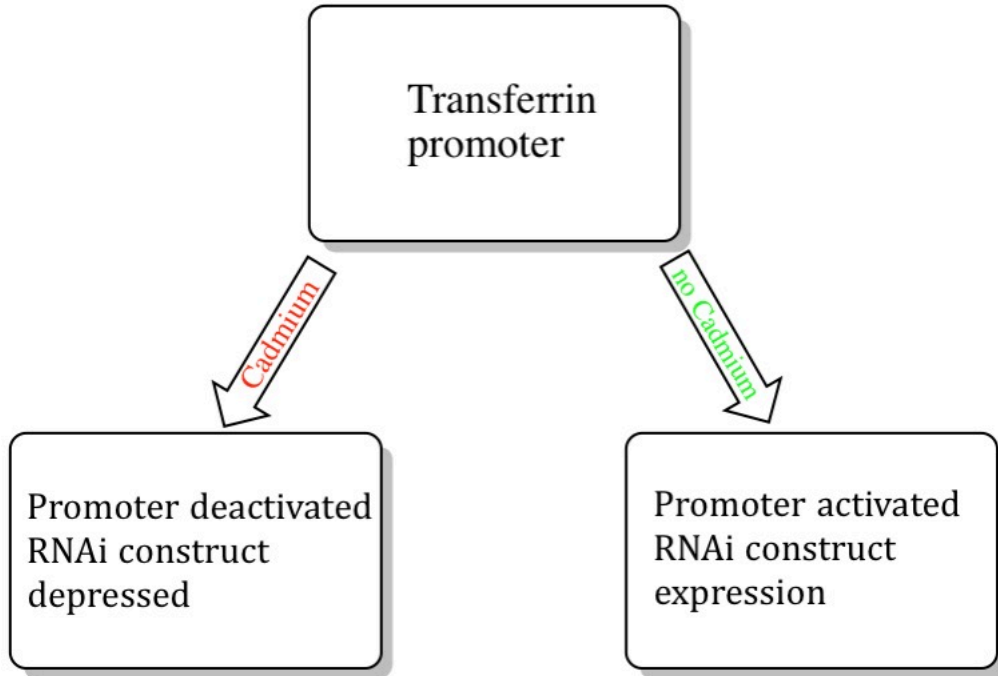

Figure 2. An example of a simplified tet-off like system, Cadmium sensitized salmon transferrin gene is used as promoter. The process is simple compared to Tet-off system.

Several alternatives might be applied as a promoter. Zebrafish *Adss2* and *racemace* (RM) genes are salt sensitive and repressed by high salt levels (Hoshijima et al. 2007). The yeast *ctr3* gene, encodes membrane-associated copper transport proteins, is copper sensitive and repressed by relatively low copper levels not likely to be seen in the environment and is regulated by *MAC1* gene (Labbe et al. 1997). Salmon *transferrin* gene encodes major iron transport protein and should be cadmium chloride sensitive and repressed by relatively low  $\text{CdCl}_2$  levels (Carginale et al. 2002) not likely to be seen in the environment. The gene promoters mentioned above may be good candidates as promoters in Tet-off-like systems because the chemical levels needed are much lower than doxycycline needed in Tet-off systems and the control of the wastes from chemicals are much easier.

Our lab has built transgenic sterilization P1 fish with both Tet-off and alternative promoters systems. In the common carp (*Cyprinus carpio*), promoters that regulate genes that are responsible for copper control, *Mctr* and *M*, and salt sensitive, *ADSS* and *RM*, drove stronger and more consistent PGC knockdown than the traditional Tet-off system (Su et al. 2014). In P1 channel catfish, copper-based systems also

showed promising results in down regulation of the PGC migration-related gene targets *nanos* and *dnd* (Su et al. 2015), among M and Mctr promoters and 4 RNAi strategies, the Mctr promoter-driven constructs and the *nanos* 3' end shRNA strategy pooled by promoter had the best repressible success when treated with copper sulfate.

Our overall objectives were to use transgenic technology to prevent PGC migration and gamete formation leading to sterility in channel catfish, and then repress this process to produce fertile brood stock that generate sterile offspring. In this study, specific objectives were to 1) measure spawning success in repressed and untreated P1 brood stock, 2) demonstrate inheritance of the sterilization constructs in the F1 and F2 generations, 3) determine the PGC marker gene expression in repressed and untreated F1 and F2 generations, 4) determine the gonadal development of putative F1 transgenically sterilized channel catfish, and 5) measure any pleiotropic effects of the transgene on traits such as body weight.

## **2. Materials and methods**

### **2.1 Construction of plasmids**

FRMwg plasmid was used as the vector for all the transgenic constructs in this experiment (Gibbs et al. 2000), and it has three components: insulator, ocean pout terminator and boundary element. In the transgenic constructs, the regulatory promoters that activate the expression of RNAi constructs included 2 antibiotic sensitized, 2 copper sensitized (one of them has reduced sequences and is less sensitive to copper than the other), 2 salt sensitized and 1 cadmium sensitized (the disposal and storage of cadmium and its waste solution followed the SOP of Auburn University). These constructs were designed and built as modified Tet-off or Tet-off-like systems (Fig.3).

The channel catfish *nanos* and *dead end* sequence were determined (Su 2012). Based on these sequences, three RNAi and one cDNA sequences were fused into the knockdown constructs targeting the marker genes (Fig.4). The knockdown strategies included: (1) a ds-sh RNA targeting the 5' end of channel catfish *nanos*



gene (N1), (2) a ds-sh RNA targeting the 3' end of channel catfish *nanos* gene (N2), (3) a full length cDNA sequence of channel catfish *nanos* gene to overexpress *nanos* (cDNA) and (4) a ds-sh RNA targeting channel catfish *dead end* gene (*dnd*). Except for the *nanos* cDNA sequence, all constructs have a short hairpin structure and double stranded RNA.

All 7 systems were applied with 4 knockdown strategies. As a result, we have 28 different knockdown constructs each to be tested with incubation in a repressor in treated group (T) and untreated group (U) (Fig.5).

## 2.2 P1 fish

Plasmids with the transgene of interest were cloned into Invitrogen Top10 *E.coli* cell, following the procedures recommended by the protocol (user guide 280126, Invitrogen). After the appropriate period of cloning cell culture, plasmid DNA was extracted using the Qiagen maxi-prep kit and linearized with *Sfi*I (20,000 units/ml, BioLabs). Plasmids were then purified using the phenol-chloroform-ethanol method and quantified using Thermo scientific Nanodrop2000®. Plasmids with transgenes were transfer into fertilized eggs using electroporation with a Baekon 2000 macromolecule transfer system. Parameters were set at 6 kV, 27 pulses, 0.8 sec burst, 4 cycles, 160 µsec (Powers et al., 1992, Su et al. 2015). Non-contact mode of electroporation with the electrode 1 to 2 mm above the buffer was applied. This procedure generated the P1 brood stock used in the current experiment.

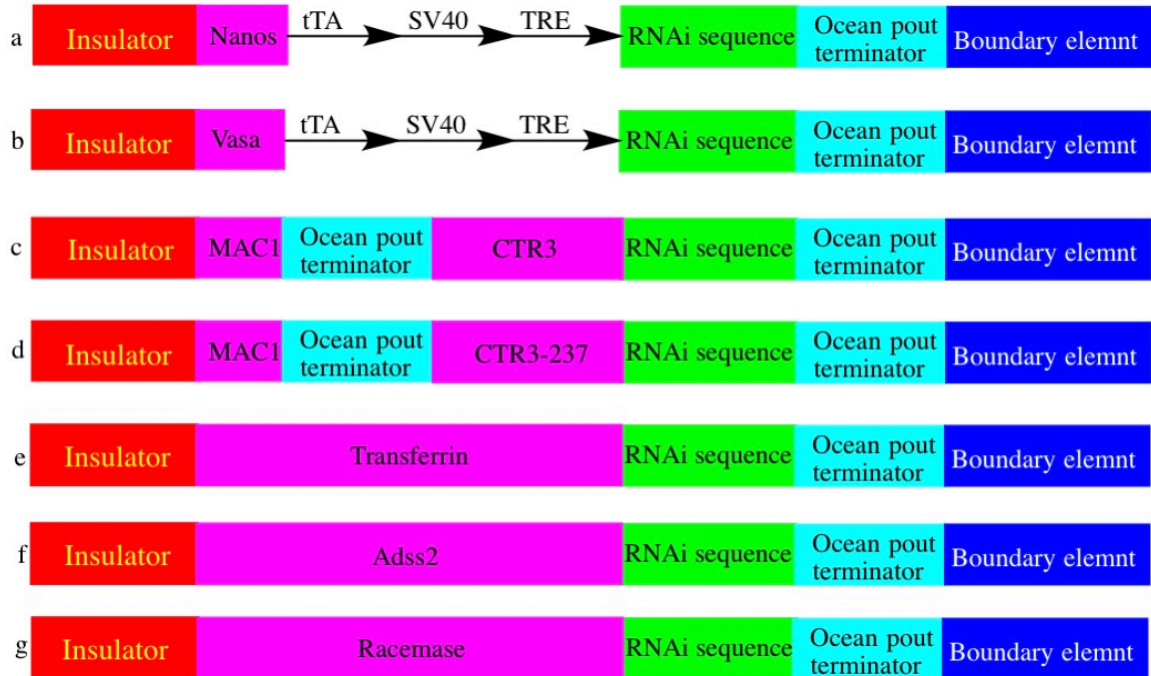

Figure 3. Primordial germ cell knockdown constructs for the sterilization of channel catfish, *Ictalurus punctatus*. **a.** *Nanos*: a modified Tet-off system using the catfish *nanos* promoter. Doxycycline was used at 100ppm or higher to repress this construct. **b.** *Vasa*: a modified Tet-off system using the catfish *vasa* promoter. Doxycycline was used at 100ppm or higher to repress this construct. **c.** Mctr3 (M): The yeast *ctr3* promoter is copper sensitive and repressed by copper levels higher than 0.1ppm and is regulated by *MAC1* gene. **d.** Mctr3-reduced (MCTR): the same concept as Mctr3 but with a reduced *ctr3* gene so that the regulation system is less sensitive to copper than Mctr3 system. **e.** Transferrin (T): The salmon *transferrin* promoter is cadmium chloride sensitive; 0.1 ppm or higher concentration of CdCl<sub>2</sub> in the incubation solution will repress the promoter. **f.** ADSS: zebrafish *Adss2* promoter is salt sensitive and repressed by 4ppt sodium chloride or higher in Holtfreter's solution. **g.** Racemase (RM): zebrafish *racemase* promoter is salt sensitive and repressed by 4ppt sodium chloride or higher in Holtfreter's solution.

**Channel catfish, *Ictalurus punctatus*: deadend ds-shRNA design**

Oligo1. 5'-GTTCCAGAGCGTAGCGCCGCTCTACGAGTTCCGAGCGGCGCTACGCTCTGGAAC-3'

Oligo2. 3'-CAAGGTCTCGCATCGCGGCGAGATGCTCAAGGCTCGCCGCGATGCGAGACCTTG-5'

**Channel catfish, *Ictalurus punctatus*: nanos ds-shRNA design**

**N1 targeting 5' end**

Oligo1. 5'-CTCTCTATCCCGATGACTCGCGATGGTGTGTTTCGCGAGTCATCGGGATAGAGAG-3'

Oligo2. 3'-GAGAGATAGGGCTACTGAGCGCTACCACAAAAAGCGCTCAGTAGCCCTATCTCTC-5'

**N2 targeting 3' end**

Oligo3. 5'-CCGAAAATCTGAACCCCACTCTCACACTCGCTAGAGTGGGGTTCAGATTTTTCGG-3'

Oligo4. 3'-GGCTTTTAGACTTGGGGTGAGAGTGTGAGCGATCTCACCCCAAGTCTAAAAAGCC-5'

**Channel catfish, *Ictalurus punctatus*: nanos full length cDNA**

GTGTTTACAGTAGCCTAGCTACGACTCTTTTTAATAATTATTGTTTTAGTAAACAAACAAACAAAATTAATGGCATGTGCGCGCTGAT  
 TGGTTCCCGCAGCAGCACCCGCTTTACGCGCCACACCGGTGTGCGCTCCAGACTCGCTACTTAAGGGGGTTCCTGGTTGTTTTAAG  
 TTTTCAACCCCTCTCTATCCCGATGACTCGCGATGGTGTGTTTCTCTGCTGCGCTACATCCTGGCGGCTCACGGCTCCATGGAGCCCGAGG  
 ACCAGCGTCACTTCCAGCCGTGGCGGATTACTTGGGTCTCGCGGACACGGTGCCTGCGATGCGGAAACCTCTGGTCCCAGAACCTCACC  
 AGGTCCAGGAGTTCGGGTTACGCCGAGATTTCTATCACCGGGCGTAATGCTGCAATGCTCCAGACTTCCCGAGCCTGAGATGT  
 CCGTGTTCAGAGGAAGACCGAAAACGCAGATGGGGCGACTGAAGTGCCTGCTACCGGGACCACAGGGCCTCCACCTCCATCACCTCAAG  
 GTTCTCGCTCTGGGAAAAGTTCTGCAGTTCTGCAACATAACGGCGAGTCTGAACAAGTGTTCACGTGCGACTGCCTGAGGAGCCGCG  
 GCGGAGCAGTGGCGTGTCTTACCTGCGCCGCTACGTGTGCTCGCAGTGCAGGGGCGACGGGCGACCGCGCGCACACCAACGCTTCTGCC  
 GCTCGTGGACAGCAGTACGCCTCCGTGTACACCCGGCTGCCGTAATGACCGAAAATCTGAACCCCACTCTCACACTCGCTACCAAAAC  
 TGTAGGTTATTCTTTTTTTTTTTTTTTTACTTGGGAAGGTGAACAAGAAGCTTTAGACAAAAGCTGCACAGGTACGTGAGCGGTCCTTA  
 AAGTCCGGTACTGTACCTGGAATGCTTTTATATGTAGGCTTCAACTATATTTTCAAAGGTAATAAGATGTACCAGTTATGATTCAAT  
 TTCAGAGAAAAGCTCAAGTACAGTGGGTGCTTTTATCTGAGAGTGGCTGTAGAAAAGTTGTAAGTCCTTTTAAAAAATAAAAAAAAAA  
 AATCAGCATTATATTTTAAATGTCTGCATTACTGTGCTTATTATATGGCTTAGAGCTGTCGGGTTTAGTTGTTGAAACTCCGGAATGA  
 CCTGCCCTGGGTTACAGCTGTAACACCTGGAACGCTGTGGGTGTCAAGAGTTTGCCTTACTAAGTTTGTGTGCACCTTTGTGTATGCAC  
 TTGTGTTGTGTGTTAATTTTGTATGTTGTTGTTTTGTTTTGAAAGCTGATTTCTCTAACGAGCTTGTGCTCAGGCTCTCTGGCTCATCAC  
 GGTGACGATGTTACAGGTGCGGCTATGACAGGCTTATGATGGACCGTGGATCTCCGACCTGCTATTTTTCTGCTCCATTTTATTG  
 TCCATTGAAAGAACTTCTGACGTGTTGTGACTTTTTAAAGTGTTTAGACCATTGGGATTTGAGTTAATATATCTTTATATGCATGTAA  
 CAAGCCTCAGTGCATTTGTTTTATATATATATAAGACGTGTTGGACTGTTTTGGTACGAATGACCTCGTCGATGCCTCTGAATCT  
 TCTGCAATTCTGAAGTTTCAATTTCTAATATATTTAAAGTGTGAAAAAAAAAAAAAAAAA

Figure 4. Primordial germ cell knockdown sequences for channel catfish, *Ictalurus punctatus*. Loops were in grey shade, stem sequences are underlined.

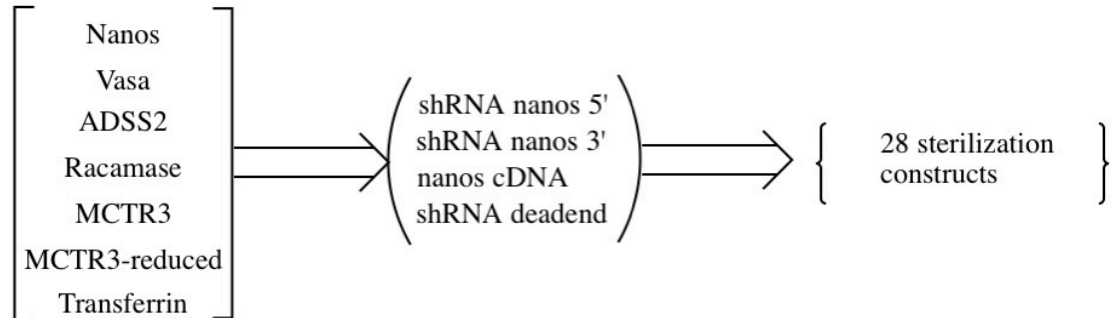

Figure 5. Seven promoters paired with 4 knockdown strategies resulting in 28 sterilization constructs for the knockdown of *nanos* and *deadend* in channel catfish, *Ictalurus punctatus*.

### 2.3 Artificial spawning and embryo culture

During catfish spawning seasons when water temperature was 25 °C or higher, gravid females were injected or implanted with luteinizing hormone releasing hormone analogue (LHRHa) to induce the maturation of eggs and sperm with a priming dose of 30 µg kg<sup>-1</sup> followed by a resolving dose of 150 µg kg<sup>-1</sup> dose 12 hours later (Su et al. 2012). When females began to ovulate they were anesthetized with sodium bicarbonate buffered 200 mgL<sup>-1</sup> tricaine methanesulfonate (MS- 222) for 10 minutes and then rinsed with freshwater (Chatakondi et al. 2011). Eggs were then hand stripped into a metal pan.

To construct P1 transgenic fish, males and females with same transgene constructs were used to produce F1 offspring. Well- developed from meshed and squeezed testes males were euthanized to remove testes. Sperm were collected and then diluted with 0.9% saline at a 1:9 sperm: saline ratio.

For fertilization, 2-3 mL diluted sperm solution was added to about 300 eggs then mixed. Enough pond water to submerge the eggs was added for fertilization. After 5 minutes, the pans with embryos were transferred to a trough with flow through water and calcium for 1 hour for water hardening. Embryos for treated groups (T) were then transferred into Holtfreter's solution (NaCl 3.5 g, NaHCO<sub>3</sub> 0.2 g, KCl 0.05 g, MgSO<sub>4</sub> 333 µL (300 g in 500 mL), CaCl<sub>2</sub> 333 µL (150 g in 500 mL), pH: 7~7.5 in 1.0 L dechlorinated water) (Armstrong et al. 1989). Untreated groups' (U) embryos were transferred into flow through troughs for paddlewheel incubation.

Treatments were administered for repression of promoters in the tubs holding approximately 100 embryos for the first 6 days of embryonic development starting from 40-50 minutes after fertilization. Incubation solutions were changed every 24 hours. Waste CdCl<sub>2</sub> solution was collected using appropriate procedures and disposed of by the Auburn University Environmental Safety Unit.

### 2.4 Embryo sample collection and RNA extraction

Triplicate samples of embryos were collected at 24, 48 and 120 hours post-fertilization (hpf) for both T and U groups. Each sample was immediately frozen in liquid nitrogen. A total of 10-15 embryos were collected per replicate,

paper towel dried and placed into 1.5mL Eppendorf tube. Samples were then stored in -80°C for future RNA or DNA extraction. Non-transgenic samples were also collected as a control.

Samples were ground into powder and dissolved in Invitrogen TRIzol<sup>®</sup> reagent (catalog # 15596-018), and RNA was then extracted following the manufacturer's instructions. The quality and concentration of all the RNA samples were checked by both gel electrophoresis and with a Thermo scientific Nanodrop2000<sup>®</sup>. All extracted samples had an  $A_{260/280}$  ratio greater than 1.8, and were diluted to around 500 ng $\mu$ L<sup>-1</sup>.

## 2.5 PCR

PCR was used to identify transgenic positive families. DNA from all families was extracted using standard procedures, then purified and diluted to work as PCR template. Eight pairs of primers were designed to amplify specific segments of the FRMwg plasmid bone structure sequence corresponding to the 7 different promoter sequences. PCR products were gel electrophoresed to identify positive families.

## 2.6 Real-time PCR

RNAs were reverse transcribed into cDNAs by iScript Synthesis Kit (Bio-Rad, catalog #: 170-8891). Each reaction consisted of a total volume of 10  $\mu$ L containing 4.0  $\mu$ L iScript reaction mix, 1.0  $\mu$ L iScript reverse transcriptase, 500 ng RNA template, and water to reach the 10  $\mu$ L volume. The reaction followed the protocol: 5 minutes at 25 °C, 30 min at 42 °C, 5 min at 85 °C. cDNA were then diluted to 200 ng $\mu$ L<sup>-1</sup>.

Quantitative Real-time PCR (qPCR) was operated on a C1000 Thermal Cycler (Bio-Rad, USA) by using SsoFast EvaGreen supermix kit (Bio-Rad, catalog: #172-5201). Reactions were performed in a 10  $\mu$ L total reaction volume (9.0  $\mu$ L mix and 1.0  $\mu$ L cDNA). The mix contained 1.0  $\mu$ L of each primer (5  $\mu$ mol $\mu$ L<sup>-1</sup>), 4.0  $\mu$ L SsoFast EvaGreen supermix, and 3.0  $\mu$ L RNase/DNase-free water. The same cycling conditions were used for all the tested samples: (1) denaturation, 95°C for 30s, (2) 40 cycles of 95°C for 5s, and 57°C for 15s followed by (3) melting curve analysis, 5s

at 65°C, then up to 95°C with a 0.1 °C temperature increase every second. The mRNA levels of all the samples were normalized to the levels of the non-transgenic control sample of the same time point measure regulation. Ribosome 18s mRNA was used as a reference gene. Crossing-point (Ct) values were exported into Excel sheet from Bio-Rad CRX Manager (Version 1.6.541.1028, 2008) to transfer in to excel format. The relative expression ratio of target gene was analyzed for significance test using a randomization test in the REST (Pfaffl et al. 2002) software assuming 100% efficiencies. The results were graphed with corresponding standard errors.

## 2.7 Gonad and growth evaluation

Approximately, 300 fry from mixed groups (transgenic untreated fish with the promoters, M, Mctr T, and non-transgenic) were stocked into a 0.04 ha pond, 7,500 fis/ha, for gonad and growth evaluation. Fish were ad-libitum with 32 % protein floating catfish feed.

Fish were harvested twice at 1 year of age and 3 years of age to evaluate the gonad development and growth of transgenic and non-transgenic groups. Fish were anesthetized with NaHCO<sub>3</sub> buffered MS-222, and the abdomen opened using a scalpel. One gonad of each fish was taken and weighed. The gonad samples were also used for DNA templates for PCR analysis to identify transgenic individuals. After examination of gonad development status and sampling, the incision was closed with suturing (Bart and Dunham. 1990) and the fish held in tanks for a week to recover before stocking back into the pond. While in the holding tanks, fish were treated with potassium permanganate at 2 ppm for 4 hours to prevent infection (Schlenk et al. 2000). Body weights of 1-year-old and 3-year-old fish were also measured to compare the growth rate between transgenic and non-transgenic groups, as well as transgenic fish with different promoters.

## 2.8 Spawning evaluation

In the summers of 2012, 2013, 2014 and 2015, 239 transgenic P1 females were harvested and induced to spawn. The spawning rates were recorded by transgenic treated and untreated, 7 promoters and 4 knockdown strategies, resulting in 56

groups in total. The records were then summarized and analyzed to reveal the spawning rate differences between knockdown strategies, between promoters and between treated and untreated groups.

## 2.9 Statistical analysis

Fisher's Exact Test and Fisher's Multi-treatment Exact Test were used to compare rates of sexual maturity and spawning between and among the different treatment groups. REST (Relative Expression Software Tool) (Pfaffl et al. 2002), using Pairwise Fixed Reallocation Randomization Test, was applied to compare the RNA expression level of the three PGC migrate marker genes (*nanos*, *vasa* and *dnd*) between treated group, untreated group and non-transgenic group and 18S was used as reference gene. Group means were used to express differences in expression between untreated, non-transgenic and treated samples. Statistical significance was performed by randomization test with 2,000 randomizations per test ( $P < 0.05$ ).

Gonad somatic index (GSI) was used to compare the gonad development of transgenic untreated and non-transgenic fish, which is the gonad weight per body weight  $\times 100$ . T-test was used to show statistical differences at  $P < 0.05$  for GSI and body weight.

### 3. Results

#### 3.1 Expression of *nanos*, *vasa* and *dead end* in channel catfish embryos

At 48 and 120 hpf *nanos* expression was declining relatively slowly, -1.7X and -4.2X, respectively. The level of *vasa* was about 7X lower at 48 hpf than at 24 hpf, and was dramatically lower, -61X at 120 hpf compared to 24 hpf. *Dead end* was down regulated 3.3X at 48hpf and 12.9X at 120hpf compared to 24 hpf (Fig.6).

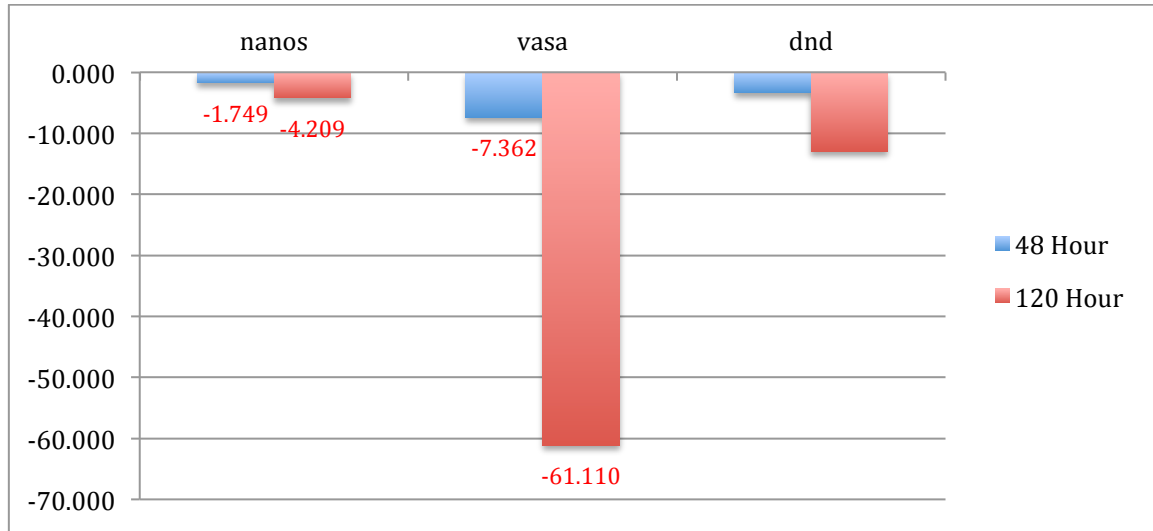

Figure 6. Expression of relative primordial germ cell (PGC) marker genes, *nanos*, *vasa*, and *dead end* (*dnd*) in non-transgenic channel catfish (*Ictalurus punctatus*) embryos. The samples were analyzed at 24, 48 and 120 hours post fertilization (hpf). Relative *nanos*, *vasa* and *dnd* genes expression at 48 hpf and 120 hpf were expressed as fold change over 24 hpf sample as normalized to change in the expression of 18s control. All the red fold values numbers shown were significant at the level of  $p < 0.05$  using Pairwise Fixed Reallocation Randomization Test (PFRR) from REST (Relative Expression Software Tool).

#### 3.2 Real-time quantitative PCR results for the F1 generation transgenic channel catfish

Variability was observed among families for each construct in regards to downregulation of the target gene and repression of the knockdown transgene. Data for 17 of 28 constructs is presented due to various experimental problems.

##### 3.2.1 5' end ShRNAi strategy targeting *nanos* gene (N1)

###### 3.2.1 5' end shRNAi strategy targeting *nanos* gene (N1)

RMN1 untreated were downregulated for *nanos* 6X to 100X at 48 hpf for the three families tested, while knockdown of *nanos* at 48 hpf in treated individuals of family c was also significant but the downregulation was much less than in untreated



individuals, (Fig.7). Also, there were off-target downregulation in *vasa* of family a and c at 24hpf, for 16X and 6X.

MN1 untreated group was significantly upregulated for the only family evaluated at 24 hpf (18X) for *nanos*, 120 hpf (5X) for *vasa*, and at 48hpf for *nanos* (9X) in the treated group, all of which were not expected results. All 3 markers genes were down regulated, 3X, 2X and 4X for *nanos*, *vasa* and *dnd* in the untreated group at 48 hpf (Fig.8). Copper had inconsistent effects on repression of the N1 construct, and even at one time point upregulated expression of *nanos*.

In 3 families sampled at 3 time points, the expression of *nanos* gene in MctrN1 was significantly down regulated 24 and 48hpf, from 5.8X-20X, especially at 48 hpf (20X) (Fig.9). *Dnd* was also down regulated at 48 hpf, for 6X. Expression changes for *nanos* gene were found in untreated individuals.

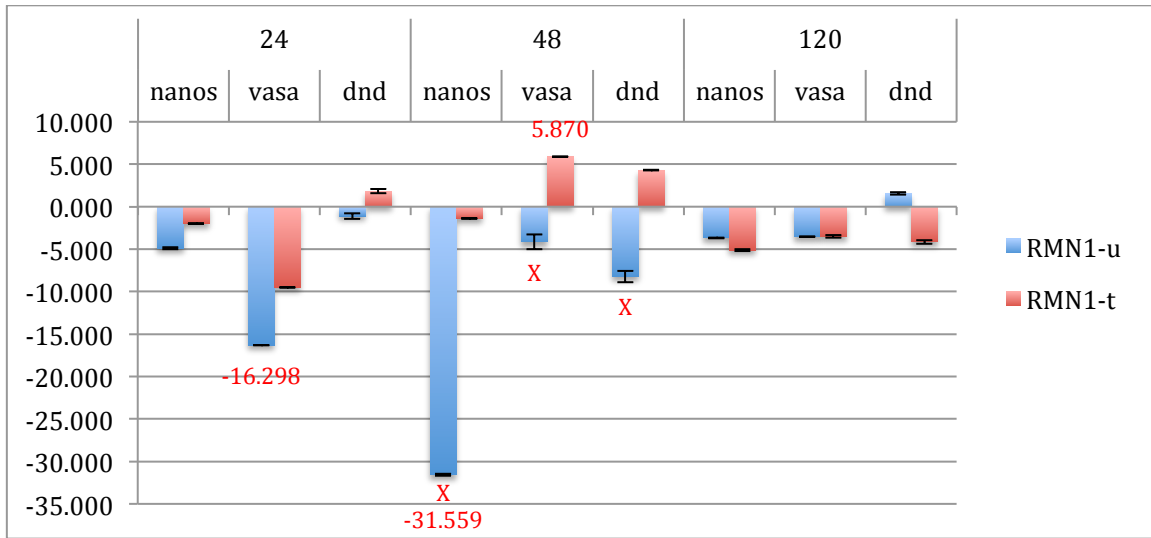

a

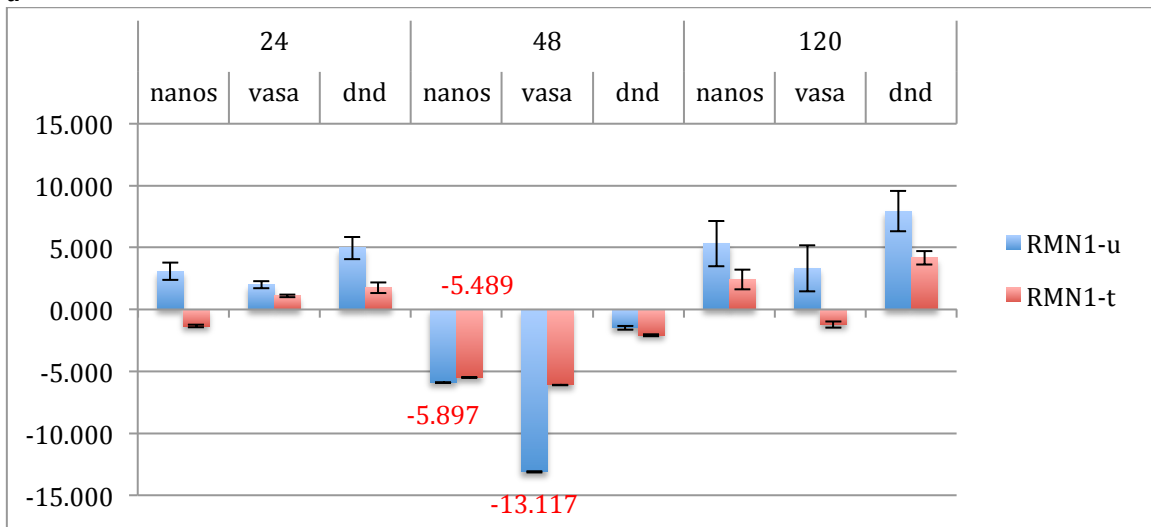

b

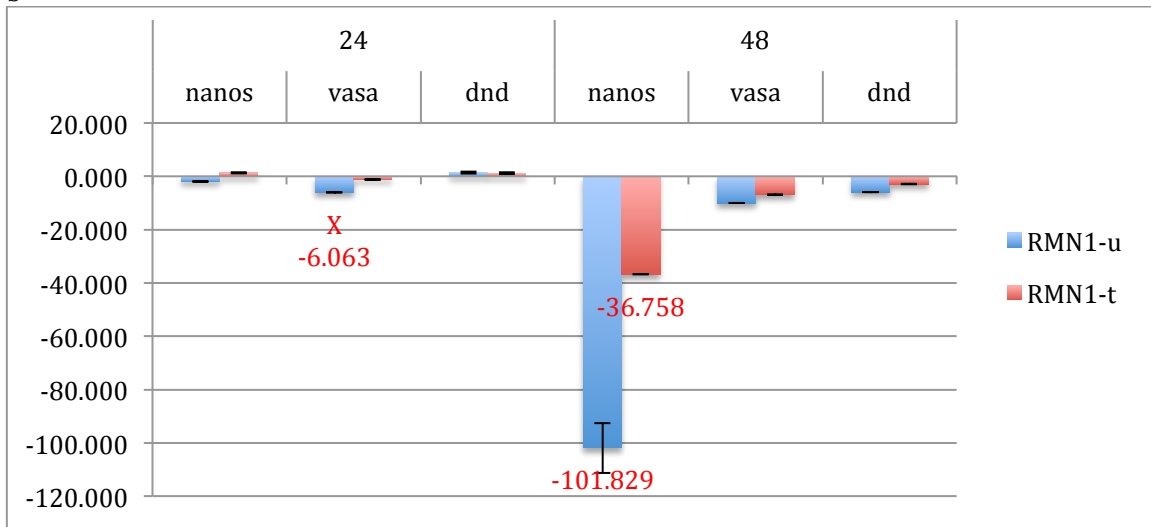

c

Figure 7. Expression of relative primordial germ cell (PGC) marker genes, *nanos*, *vasa*, and *dead end (dnd)* in the treated and untreated zebrafish *racemase* gene (RM) promoter fused with 5' end shRNAi targeting channel catfish *nanos* (N1) F1 transgenic RMN1channel catfish (*Ictalurus punctatus*) embryos. Treated group were treated with 4ppt sodium chloride. Relative *nanos*, *vasa*, and *dead end (dnd)* genes expression were expressed as fold change over non-transgenic control samples at the same time point. All the red fold values numbers shown were significant at the level of  $p < 0.05$  using Pairwise Fixed Reallocation Randomization Test (PFRR) from REST (Relative Expression Software Tool). (a, b) samples were analyzed at 24, 48 and 120 hours post fertilization (hpf), respectively. (c) Samples were analyzed at 24 and 48 hpf. Red X on the SE bar indicated the relative expression between treated and control was significantly different from each other using PFRR.

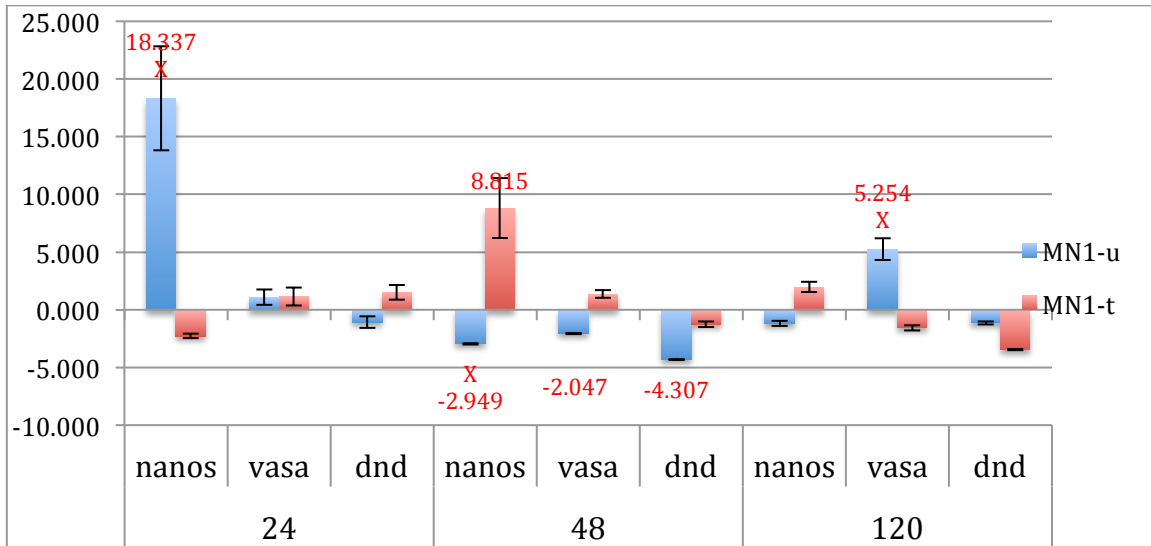
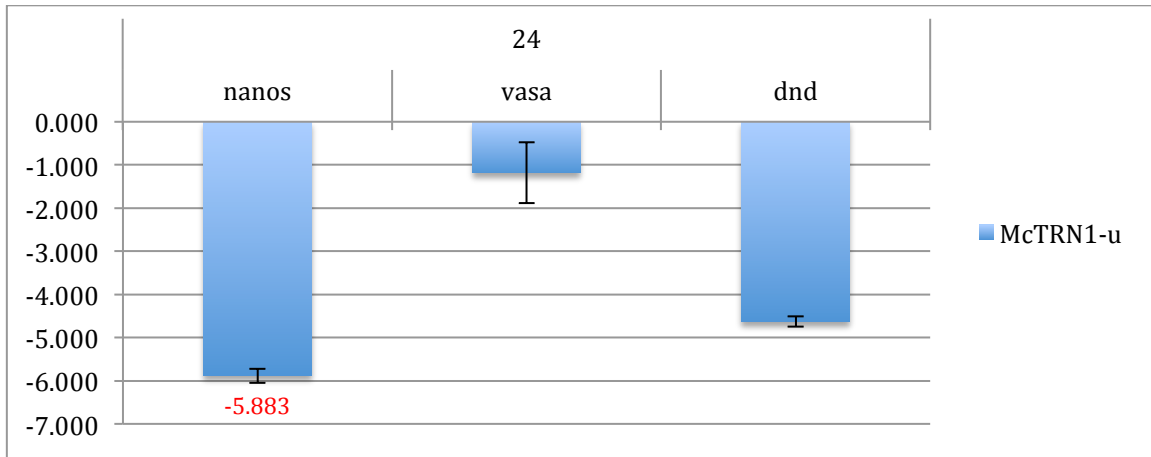
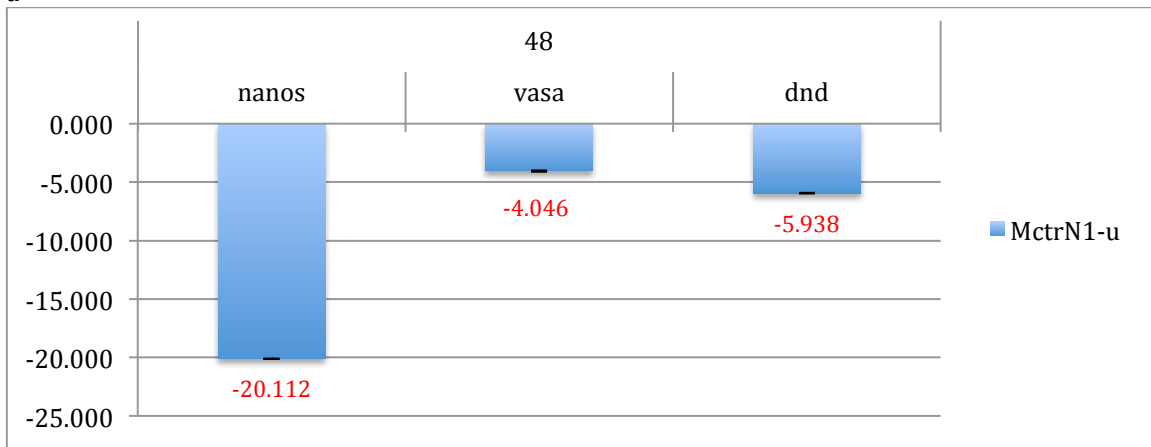

Figure 8. Expression of relative primordial germ cell (PGC) marker genes, *nanos*, *vasa*, and *dead end (dnd)* in the treated and untreated yeast *mctr3* gene (M) promoter fused with 5' end shRNAi targeting channel catfish *nanos* gene (N1) F1 MN1 transgenic channel catfish (*Ictalurus punctatus*) embryos. Treated group were treated with 0.1ppm copper. The samples were analyzed at 24, 48 and 120 hours post fertilization (hpf), respectively. Relative *nanos*, *vasa*, and *dead end (dnd)* genes expression were expressed as fold change over non-transgenic control samples at the same time point. All the red fold values numbers shown were significant at the level of  $p < 0.05$  using Pairwise Fixed Reallocation Randomization Test (PFRR) from REST (Relative Expression Software Tool). Red X on the SE bar indicated the relative expression between treated and control was significantly different from each other using PFRR.



a



b

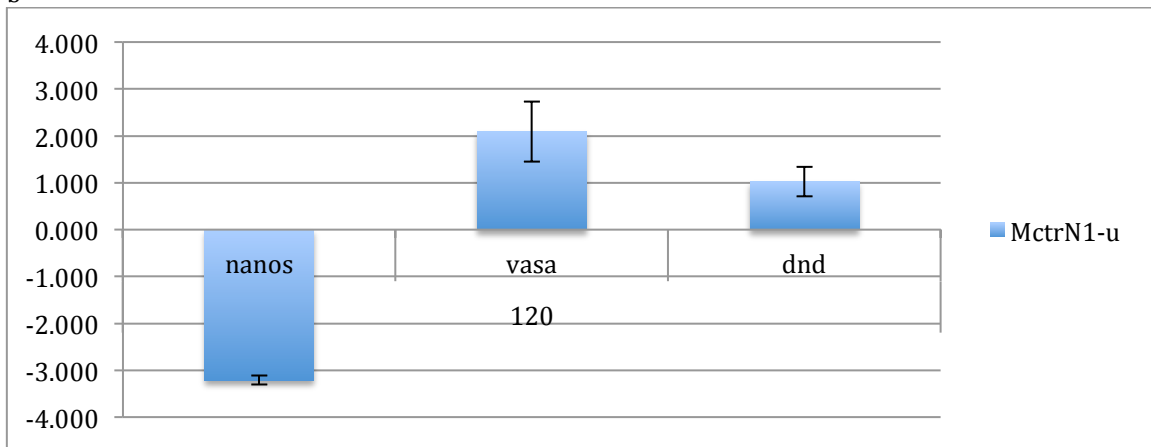

c

Figure 9. Expression of relative primordial germ cell (PGC) marker genes, *nanos*, *vasa*, and *dead end (dnd)* in untreated yeast *mctr3*-reduced gene (Mctr) promoter fused with 5' end shRNAi targeting channel catfish *nanos* gene (N1) F1 MctrN1 transgenic channel catfish (*Ictalurus punctatus*) embryos. Treated group were treated with 0.1ppm copper. The samples were analyzed at 24 (a), 48 (b) and 120 (c) hours post fertilization (hpf). Relative *nanos*, *vasa*, and *dead end (dnd)* genes expression were expressed as fold change over non-transgenic control samples at the same time point. All the red fold values numbers shown were significant at the level of  $p < 0.05$  using Pairwise Fixed Reallocation Randomization Test (PFRR) from REST (Relative Expression Software Tool).

### 3.2.2 3' end shRNAi strategy targeting *nanos* gene (N2)

The one family evaluated for AdssN2 yielded results near that hypothesized. *Nanos* was down regulated at all 3 time points, 16.7X at 48hpf and 40X at 120 hpf (Fig.10), in the untreated group. Most time points from the treated group had similar expression patterns as the non-transgenic control, except *dnd* at 48 hpf, which was significantly up regulated for 11.8X.

In the case of RMN2, all 4 untreated families were down regulated for *nanos* (1.6X to 60X). This was especially significant at 24 hpf in family a and 120 hpf in family d, 60x and 55X downregulation, respectively (Fig.11). In some cases, off-target effects occurred as *vasa* and *dnd* also had decreased expression. For treated groups, 120 hpf *nanos* and *vasa* were significantly up regulated in response to the salt treatment.

*Nanos* was significantly down regulated by MN2 in the untreated group at 24 hpf in family b (19X) and 120 hpf in family a (10X) (Fig.12). At 120 hpf in family a of the untreated group, *vasa* and *dnd* were slightly down regulated. In the treated group of family a, the following were upregulated, *vasa* (3.9X) at 48 hpf, *dnd* (5.4X) at 48 hpf and *nanos* (6.3X) at 120 hpf.

MctrN2 was another construct for which the hypothetical downregulation of *nanos* and repression by copper met expectations (Fig.13). In the untreated groups for all three families evaluated, *nanos* gene was strongly down regulated at all time points, from 3.9X to 20.5X. Significant down regulation was observed at 48 hpf for family a (12.4X), 24 hpf for family b (20.5X) and 48 hpf for family c (8.9X). A very strong off target effect was observed for 24 hpf *vasa* from family b.

A single example of TN2 also downregulated *nanos* as expected and the cadmium chloride successfully prevented promotion by the salmon transferrin promoter of the construct (Fig. 14). In the untreated group, *nanos* was significantly down regulated at all time points, 17.1X at 24 hpf, 25.2X at 48 hpf and 10.8x at 120 hpf. A strong off target effect depressed *vasa* expression at 24 hpf (11.9X) and 48 hpf (21X), but not at 120 hpf (1.7X).

The single example of NanosN2 did not function as expected. The knock down of *nanos* was ineffective at all 3 time points in the untreated group (Fig.15). Significant

off target effects were observed for the untreated *vasa* group but in variable directions at 24 (down 4,4X), 48 (down 11.6X) hpf and 120 (up 11X) hpf.

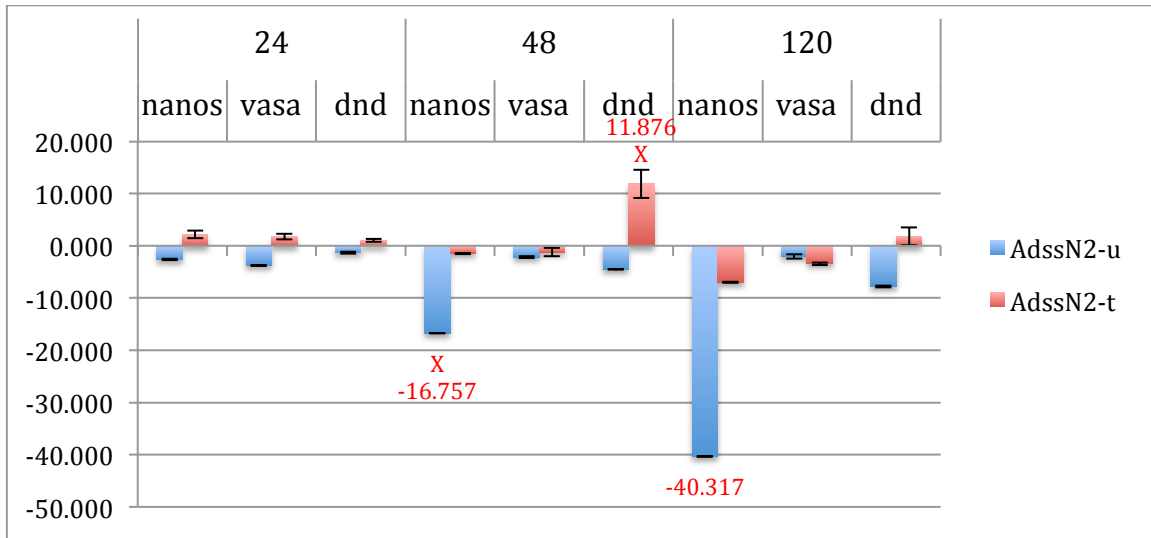
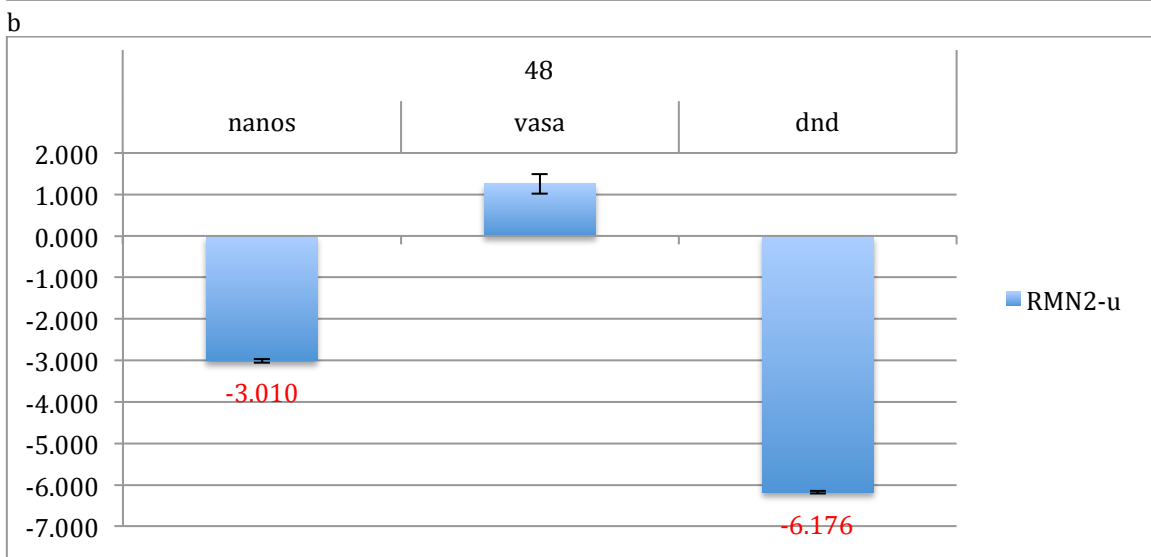
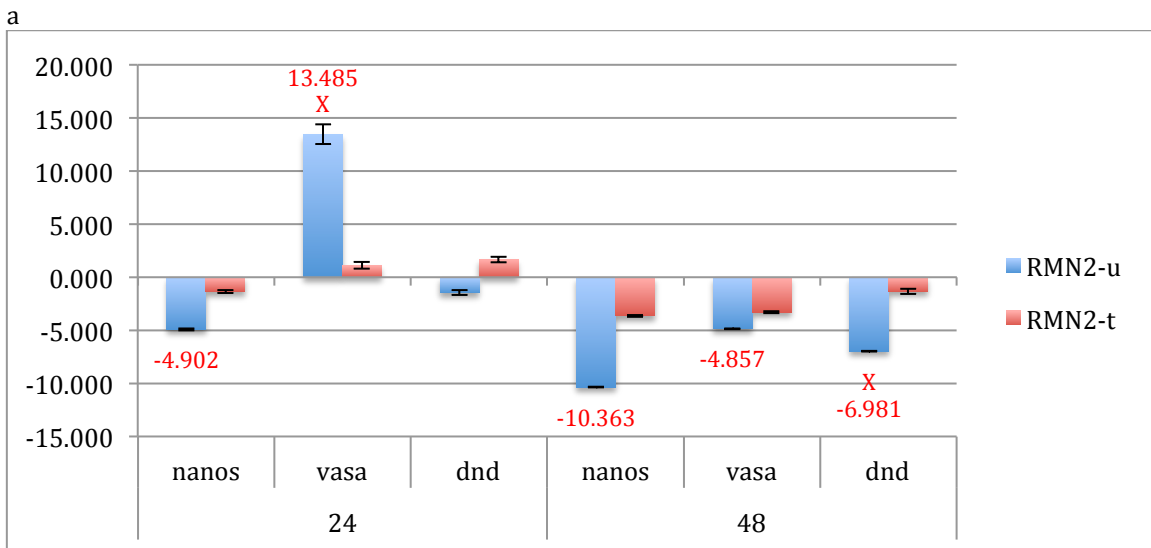
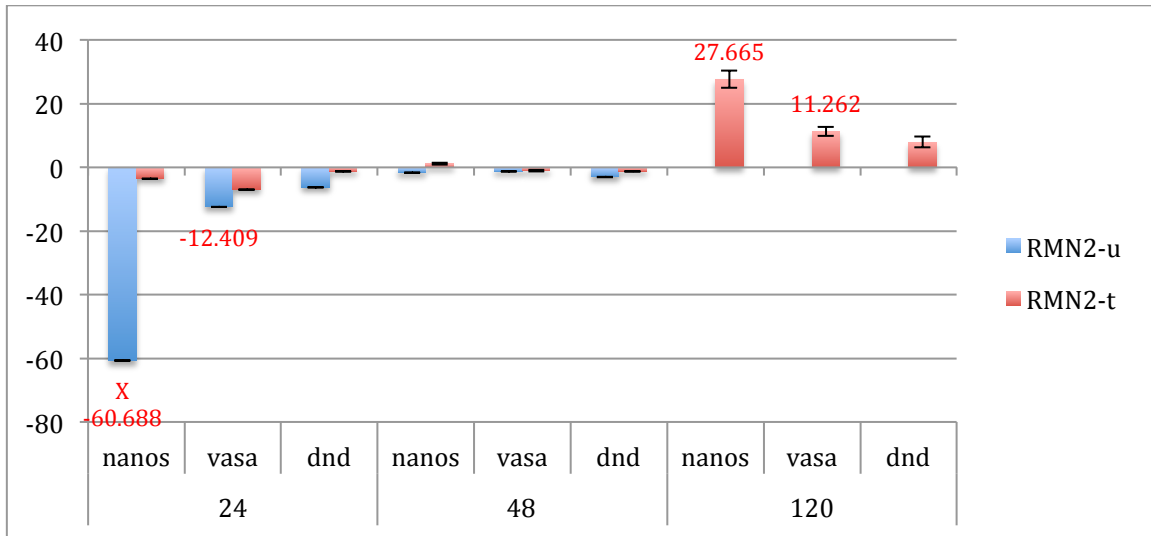
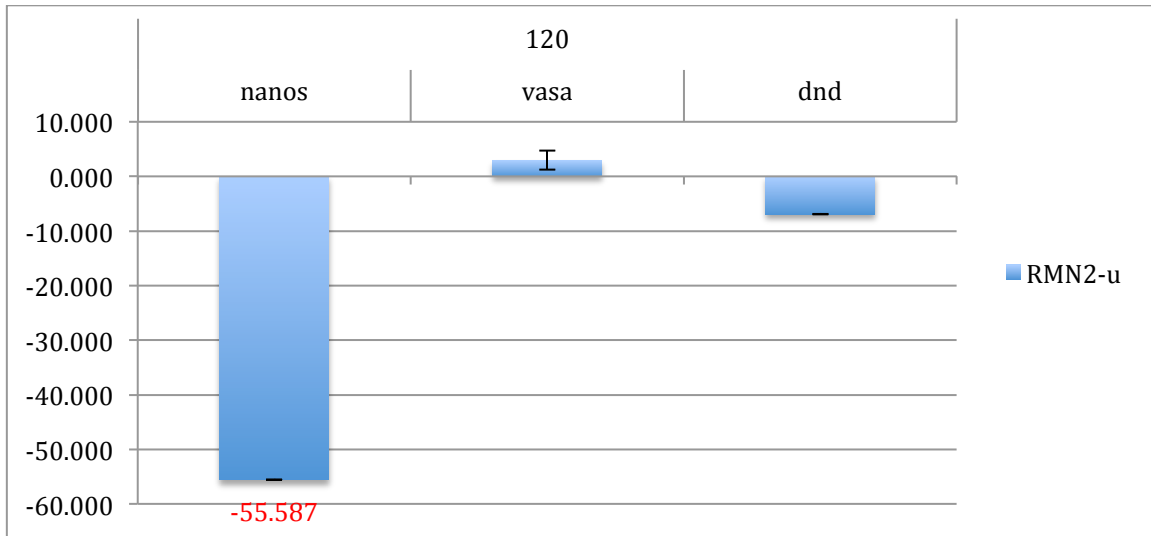

Figure 10. Expression of relative primordial germ cell (PGC) marker genes, *nanos*, *vasa*, and *dead end (dnd)* in treated and untreated zebrafish *adss2* gene (*Adss*) promoter fused with 3' end shRNAi targeting channel catfish *nanos* gene (N2) F1 *AdssN2* transgenic channel catfish (*Ictalurus punctatus*) embryos. Treated group were treated with 4ppt sodium chloride. The samples were analyzed at 24, 48 and 120 hours post fertilization (hpf), respectively. Relative *nanos*, *vasa*, and *dead end (dnd)* genes expression were expressed as fold change over non-transgenic control samples at the same time point. All the red fold values numbers shown were significant at the level of  $p < 0.05$  using Pairwise Fixed Reallocation Randomization Test (PFRR) from REST (Relative Expression Software Tool). Red X on the SE bar indicated the relative expression between treated and control was significantly different from each other using PFRR.





c



d  
 Figure 11. Expression of relative primordial germ cell (PGC) marker genes, *nanos*, *vasa*, and *dead end (dnd)* in zebrafish racemase gene (RM) promoter fused with 3' end shRNAi targeting channel catfish *nanos* gene (N2) F1 RMN2 transgenic channel catfish (*Ictalurus punctatus*) embryos. Treated group were treated with 4ppt sodium chloride. (a) The samples were analyzed at 24, 48 and 120 hours post fertilization (hpf) in treated and 24, 48 in untreated. (b) The samples were analyzed at 24 and 48 in untreated and treated (c) The samples were analyzed at 48 in untreated. (d) The samples were analyzed at 120hpf in untreated. Relative *nanos*, *vasa*, and *dead end (dnd)* genes expression were expressed as fold change over non-transgenic control samples at the same time point. All the red fold values numbers shown were significant at the level of  $p < 0.05$  using Pairwise Fixed Reallocation Randomization Test (PFRR) from REST (Relative Expression Software Tool). Red X on the SE bar indicated the relative expression between treated and control was significantly different from each other using PFRR.

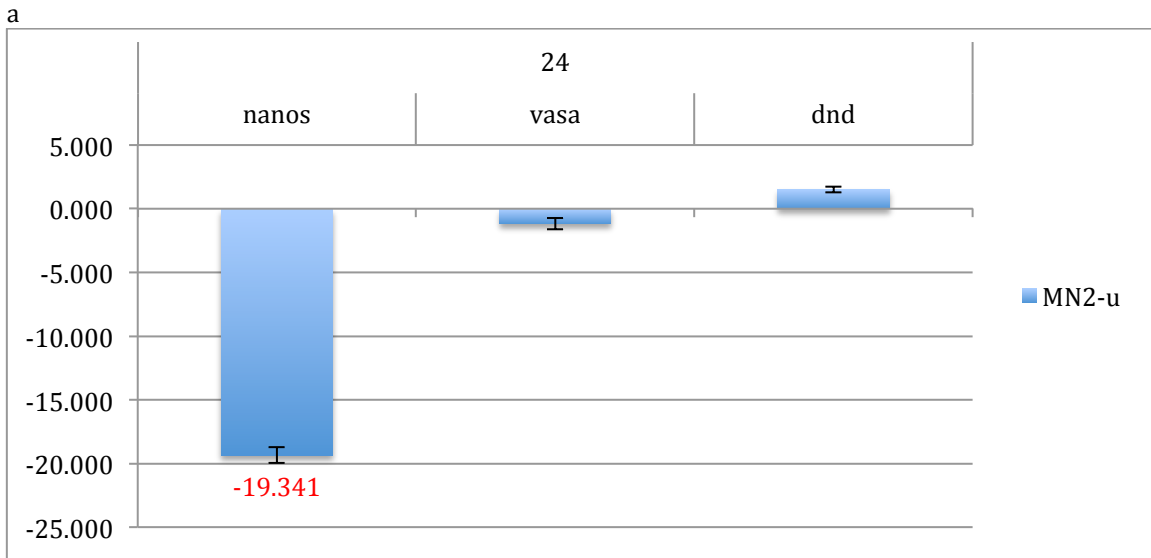
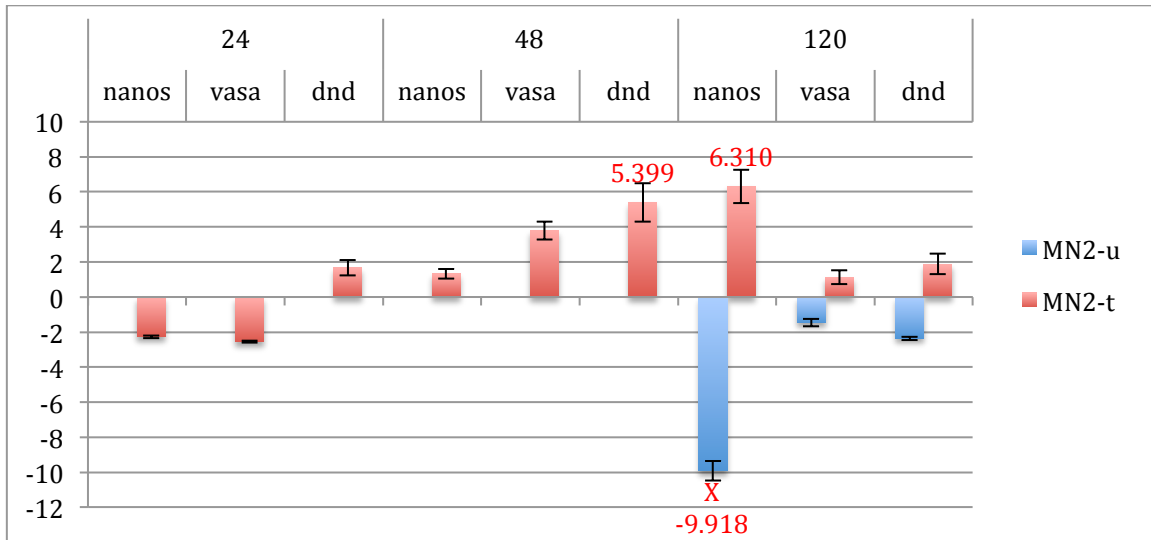

b

Figure 12. Expression of relative primordial germ cell (PGC) marker genes, *nanos*, *vasa*, and *dead end (dnd)* in yeast *mctr3* gene (M) promoter fused with 3' end shRNAi targeting channel catfish *nanos* gene (N2) F1 MN2 transgenic channel catfish (*Ictalurus punctatus*) embryos. Treated group were treated with 0.1ppm copper. (a) The samples were analyzed at 24, 48 and 120 hours post fertilization (hpf) in treated and 120 hpf in untreated. (b) The samples were analyzed at 24 hpf in untreated. Relative *nanos*, *vasa*, and *dead end (dnd)* genes expression were expressed as fold change over non-transgenic control samples at the same time point. All the red fold values numbers shown were significant at the level of  $p < 0.05$  using Pairwise Fixed Reallocation Randomization Test (PFRR) from REST (Relative Expression Software Tool). Red X on the SE bar indicated the relative expression between treated and control was significantly different from each other using PFRR.

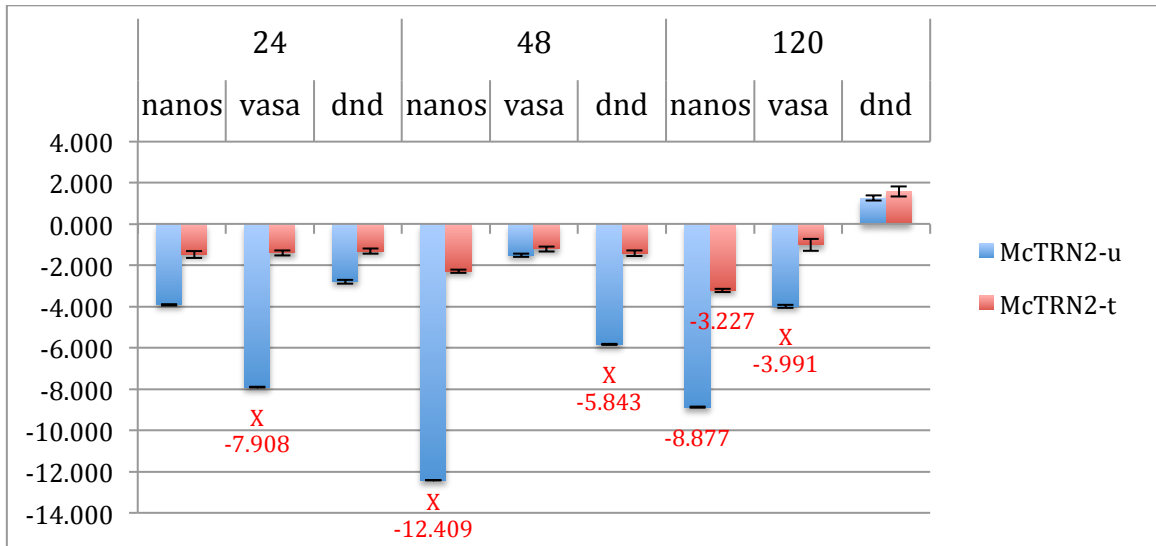

a

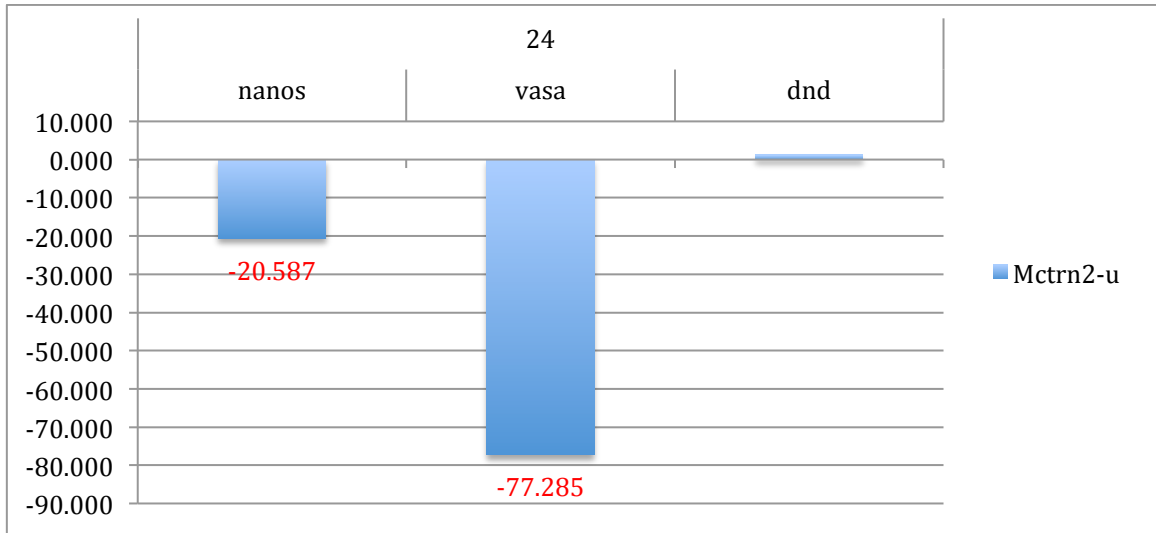

b

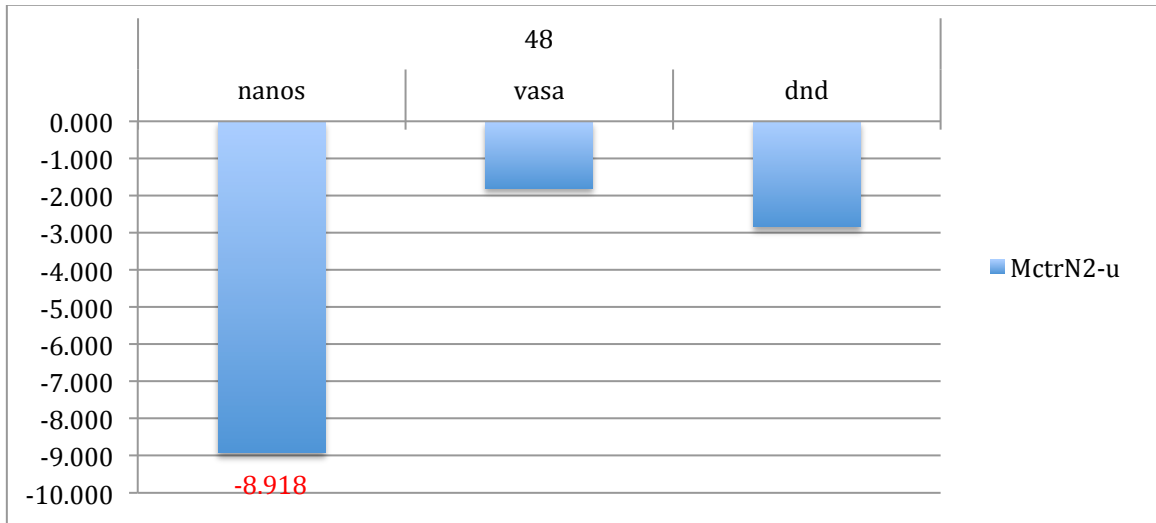

c

Figure13. Expression of relative primordial germ cell (PGC) marker genes, *nanos*, *vasa*, and *dead end (dnd)* in treated and untreated yeast *mctr3*-reduced gene (Mctr) promoter fused with 3' end shRNAi targeting channel catfish *nanos* gene (N2) F1 MctrN2 transgenic channel catfish (*Ictalurus punctatus*) embryos. Treated group were treated with 0.1ppm copper. (a) The samples were analyzed at 24, 48 and 120 hours post fertilization (hpf), respectively. (b) The samples were analyzed at 24 hpf in untreated. (c) The samples were analyzed at 48 hpf in untreated. Relative *nanos*, *vasa*, and *dead end (dnd)* genes expression were expressed as fold change over non-transgenic control samples at the same time point. All the red fold values numbers shown were significant at the level of  $p < 0.05$  using Pairwise Fixed Reallocation Randomization Test (PFRR) from REST (Relative Expression Software Tool). Red X on the SE bar indicated the relative expression between treated and control was significantly different from each other using PFRR.

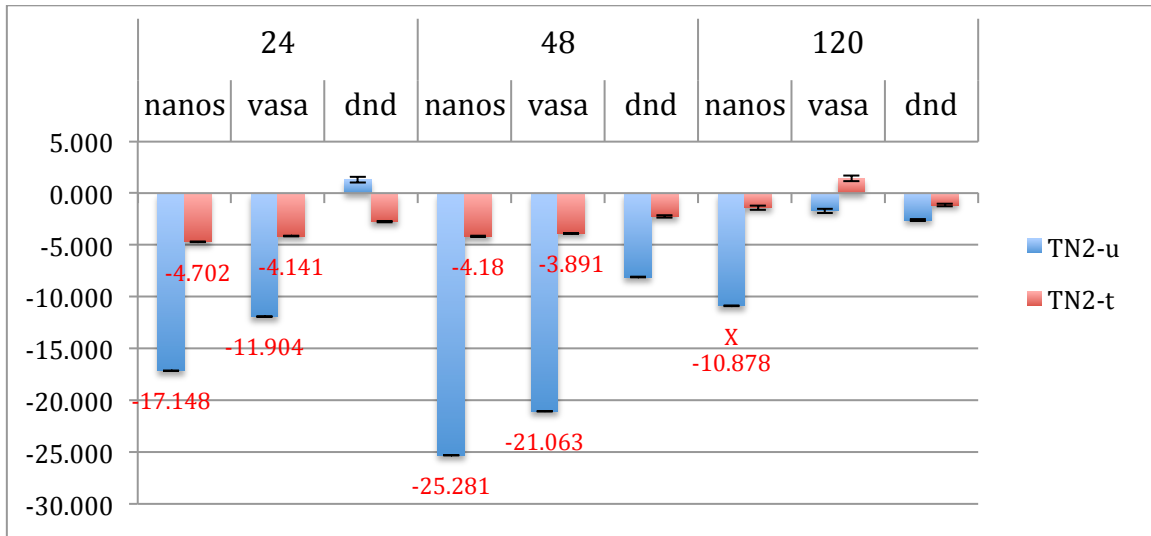

Figure 14. Expression of relative primordial germ cell (PGC) marker genes, *nanos*, *vasa*, and *dead end (dnd)* in treated and untreated salmon *transferrin* gene (T) promoter fused with 3' end shRNAi targeting channel catfish *nanos* gene (N2) F1 TN2 transgenic channel catfish (*Ictalurus punctatus*) embryos. Treated group were treated with 0.1ppm cadmium chloride. The samples were analyzed at 24, 48 and 120 hours post fertilization (hpf), respectively. Relative *nanos*, *vasa*, and *dead end (dnd)* genes expression were expressed as fold change over non-transgenic control samples at the same time point. All the red fold values numbers shown were significant at the level of  $p < 0.05$  using Pairwise Fixed Reallocation Randomization Test (PFRR) from REST (Relative Expression Software Tool). Red X on the SE bar indicated the relative expression between treated and control was significantly different from each other using PFRR.

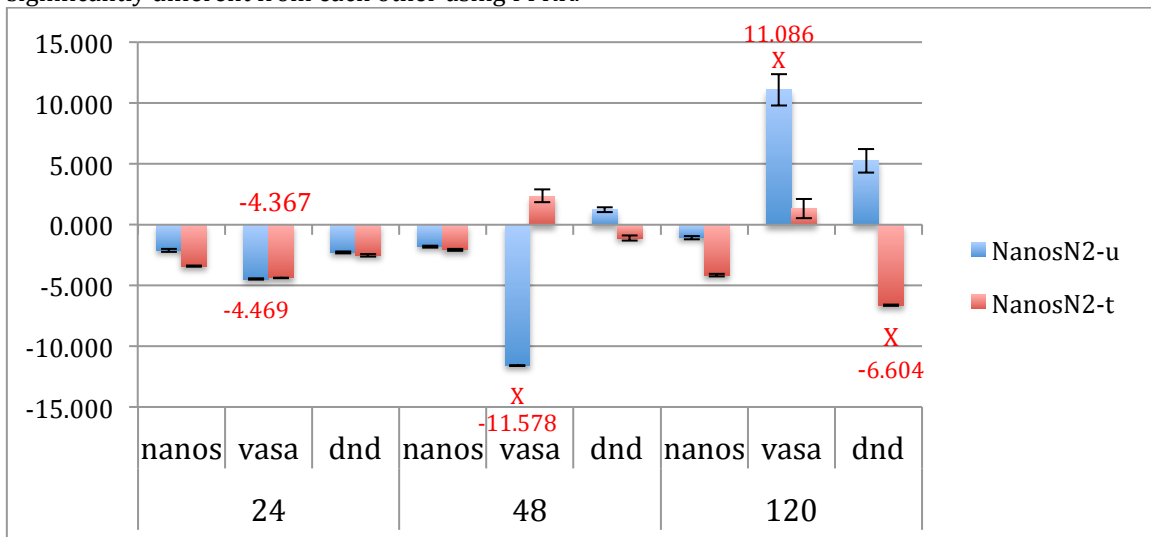

Figure 15. Expression of relative primordial germ cell (PGC) marker genes, *nanos*, *vasa*, and *dead end (dnd)* in treated and untreated channel catfish *nanos* gene (Nanos) promoter fused with 3' end shRNAi targeting channel catfish *nanos* gene (N2) F1 NanosN2 transgenic channel catfish (*Ictalurus punctatus*) embryos. Treated group were treated with 100ppm doxycycline. The samples were analyzed at 24, 48 and 120 hours post fertilization (hpf), respectively. Relative *nanos*, *vasa*, and *dead end (dnd)* genes expression were expressed as fold change over non-transgenic control samples at the same time point. All the red fold values numbers shown were significant at the level of  $p < 0.05$  using Pairwise Fixed Reallocation Randomization Test (PFRR) from REST (Relative Expression Software Tool). Red X on the SE bar indicated the relative expression between treated and control was significantly different from each other using PFRR.

### 3.2.3 *nanos* cDNA target catfish *nanos* gene (cDNA)

AdsscDNA down regulated *nanos* at all times in the untreated groups (Fig.16), especially at 48 hpf (9.3X) in family a and 24 hpf (23.6X) in family b. Fish with this construct were consistently downregulated for *vasa*.

The untreated RMcDNA *nanos* group was significantly up regulated at 48 hpf and 120 hpf from 5.5X to 13.5X in two families (Fig.17). In the treated group, *nanos* was also significantly up regulated at all three time points for both families (from 3.5X-9.2X). Strong off-target effects were apparent for family a at 24 hpf (up 9.1X) and 120 hpf (up 11.4X) and for family b at 120 hpf (down 6.8X) for *vasa*.

The untreated McDNA group was significantly up regulated for *nanos* at 48 (2.5X) and 120 hpf (10.1X) (Fig.18). Off-target effects, downregulation, occurred at 48 hpf (2.7x) and 120 hpf (8.2X) for *vasa* and 48hpf hpf (7.2X) for *dnd*.

In the untreated group, TcDNA, *nanos* was significantly up regulated at 48 (22X) and 120 hpf (9.4X) (Fig.19). For the treated group, *nanos* was significantly down regulated at 48 (4.6X) and 120 hpf (3.7X), indicating that the 4 ppt sodium chloride treatment was very effective for turning off the TcDNA construct.

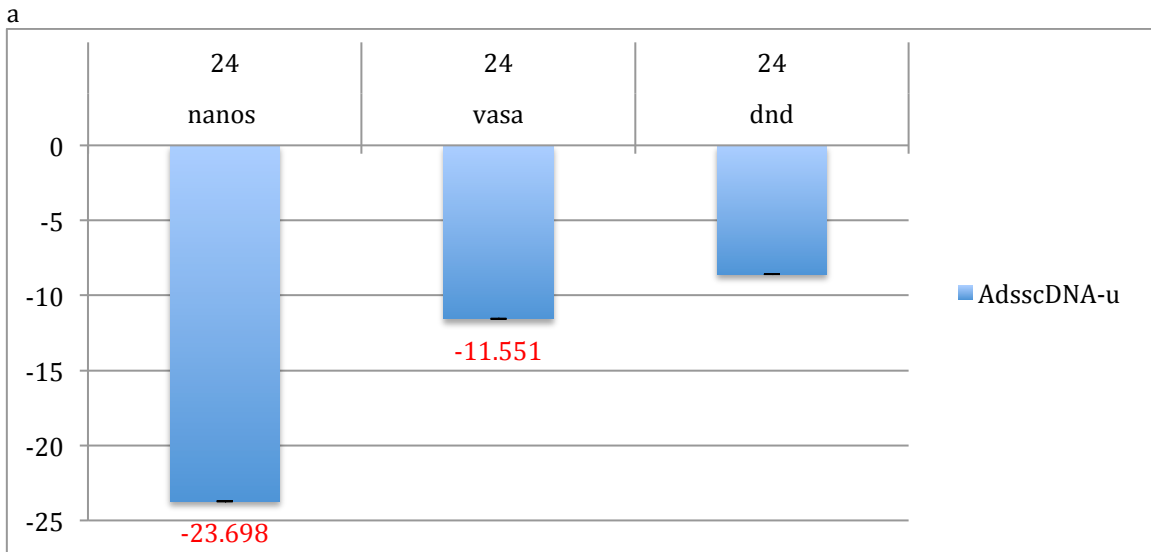
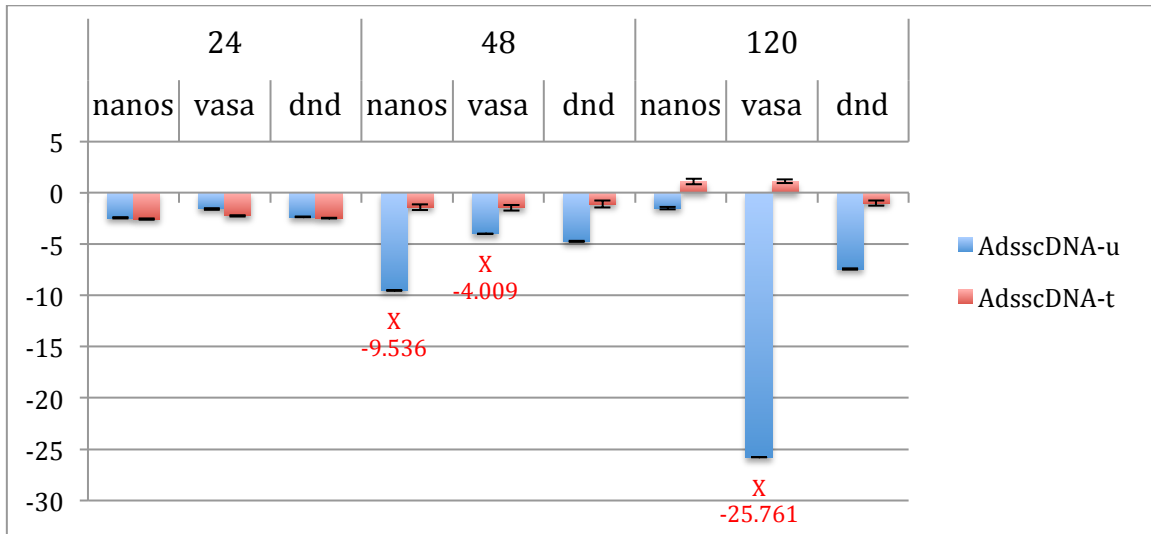

b

Figure 16. Expression of relative primordial germ cell (PGC) marker genes, *nanos*, *vasa*, and *dead end (dnd)* in treated and untreated zebrafish *adss2* gene (*Adss*) promoter fused with cDNA of channel catfish *nanos* gene (cDNA) F1 AdsscDNA transgenic channel catfish (*Ictalurus punctatus*) embryos. Treated group were treated with 4ppt sodium chloride. (a) The samples were analyzed at 24, 48 and 120 hours post fertilization (hpf), respectively. (b) The samples were analyzed at 24 hpf in untreated. Relative *nanos*, *vasa*, and *dead end (dnd)* genes expression were expressed as fold change over non-transgenic control samples at the same time point. All the red fold values numbers shown were significant at the level of  $p < 0.05$  using Pairwise Fixed Reallocation Randomization Test (PFRR) from REST (Relative Expression Software Tool). Red X on the SE bar indicated the relative expression between treated and control was significantly different from each other using PFRR.



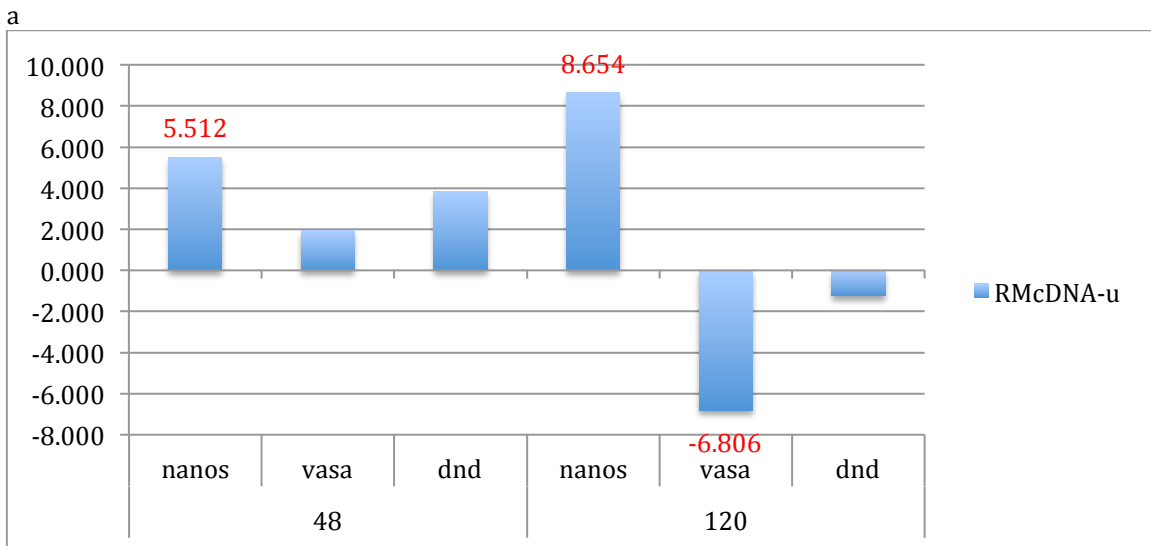
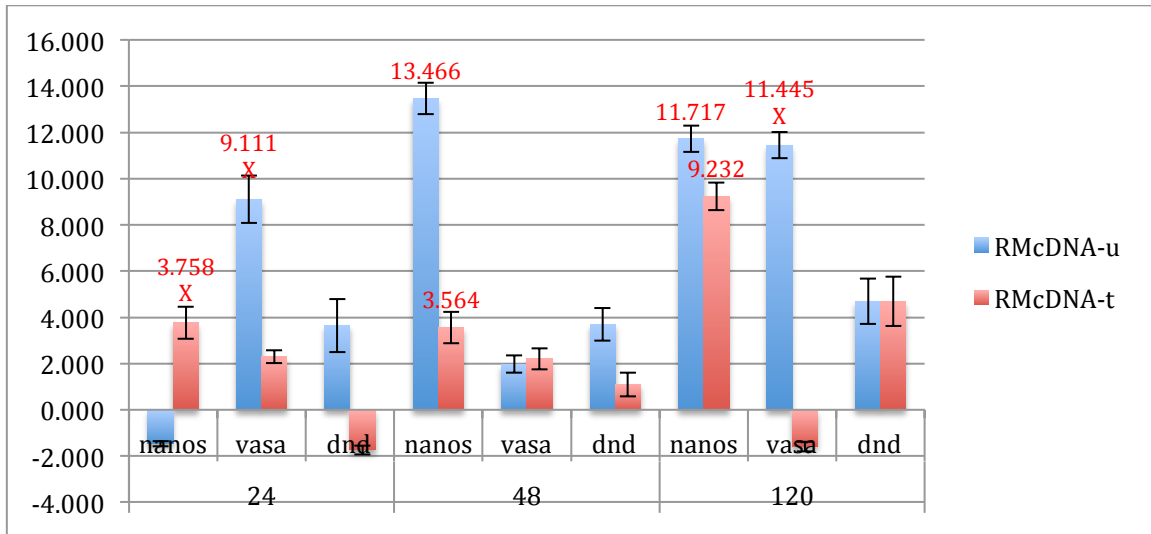

b

Figure 17. Expression of relative primordial germ cell (PGC) marker genes, *nanos*, *vasa*, and *dead end (dnd)* in treated and untreated zebrafish *racemase* gene (RM) promoter fused with cDNA of channel catfish *nanos* gene (cDNA) F1 RMcDNA transgenic channel catfish (*Ictalurus punctatus*) embryos. Treated group were treated with 4ppt sodium chloride. (a) The samples were analyzed at 24, 48 and 120 hours post fertilization (hpf), respectively. (b) The samples were analyzed at 48 and 120 hpf in untreated. Relative *nanos*, *vasa*, and *dead end (dnd)* genes expression were expressed as fold change over non-transgenic control samples at the same time point. All the red fold values numbers shown were significant at the level of  $p < 0.05$  using Pairwise Fixed Reallocation Randomization Test (PFRR) from REST (Relative Expression Software Tool). Red X on the SE bar indicated the relative expression between treated and control was significantly different from each other using PFRR.

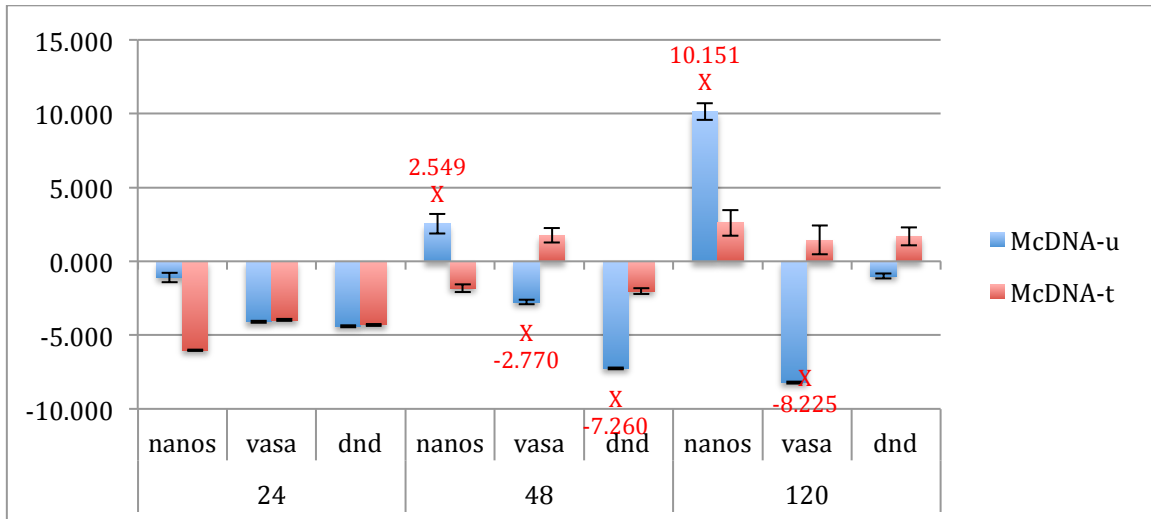

Figure 18. Expression of relative primordial germ cell (PGC) marker genes, *nanos*, *vasa*, and *dead end (dnd)* in treated and untreated yeast *mctr3* gene (M) promoter fused with cDNA of channel catfish *nanos* gene (cDNA) F1 McDNA transgenic channel catfish (*Ictalurus punctatus*) embryos. Treated group were treated with 0.1ppm copper. The samples were analyzed at 24, 48 and 120 hours post fertilization (hpf), respectively. Relative *nanos*, *vasa*, and *dead end (dnd)* genes expression were expressed as fold change over non-transgenic control samples at the same time point. All the red fold values numbers shown were significant at the level of  $p < 0.05$  using Pairwise Fixed Reallocation Randomization Test (PFRR) from REST (Relative Expression Software Tool). Red X on the SE bar indicated the relative expression between treated and control was significantly different from each other using PFRR.

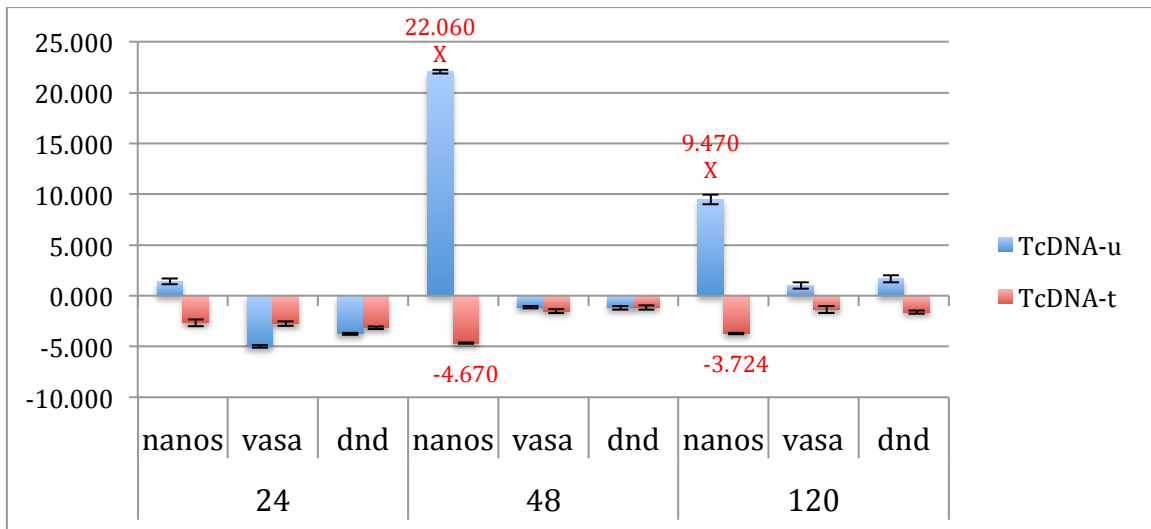

Figure 19. Expression of relative primordial germ cell (PGC) marker genes, *nanos*, *vasa*, and *dead end (dnd)* in treated and untreated salmon *transferrin* gene (T) promoter fused with cDNA of channel catfish *nanos* gene (cDNA) F1 TcDNA transgenic channel catfish (*Ictalurus punctatus*) embryos. Treated group were treated with 0.1ppm cadmium chloride. The samples were analyzed at 24, 48 and 120 hours post fertilization (hpf), respectively. Relative *nanos*, *vasa*, and *dead end (dnd)* genes expression were expressed as fold change over non-transgenic control samples at the same time point. All the red fold values numbers shown were significant at the level of  $p < 0.05$  using Pairwise Fixed Reallocation Randomization Test (PFRR) from REST (Relative Expression Software Tool). Red X on the SE bar indicated the relative expression between treated and control was significantly different from each other using PFRR.

### 3.2.4 shRNAi targeting catfish *dead end* gene

The untreated AdssDND group was significantly down regulated for *dead end* at 48 hpf (13.3X) in family a and 120hpf (18.6X) in family b (Fig.20). Significant off-target down regulation was observed in both untreated *nanos* and *vasa* at all 3 time points. 24 hpf in family a's *nanos* (8.6X) and *vasa* (9.5X) and 120hpf (11.2X) in family b's *nanos*.

An example of the MDND system worked well. MDND untreated embryos were down regulated at 24, 48 and 120 hpf for *dnd*, from 2.7X to 6.6X (Fig.21), Full-sibling embryos treated with copper sulfate were not down regulated for *dnd*. This construct had off target effects for untreated individuals at 24hpf for *vasa* and at 120 hpf for *nanos* as both treated and untreated embryos were significantly down regulated.

The expression of pattern of *dnd* in untreated TDND individuals was near expectations as *dnd* was significantly down regulated, 9.5X, 24.9X and 18.7X, at 24, 48 and 120 phf, respectively (Fig.22). The cadmium chloride treatment returned expression levels to near normal. Strong and significant off target effects were observed at 48hpf for *vasa* (82.7X, down) for untreated individuals, and 120 hpf for *nanos* for treated and untreated embryos (11.3X and 34.8X, down, respectively).

One example of the VasaDND system appeared relatively ineffective as PGC marker gene expression was not significantly changed in untreated individuals. Embryos treated with doxycycline actually had increased *dnd* expression (23.3X) at 24hpf (Fig.23).

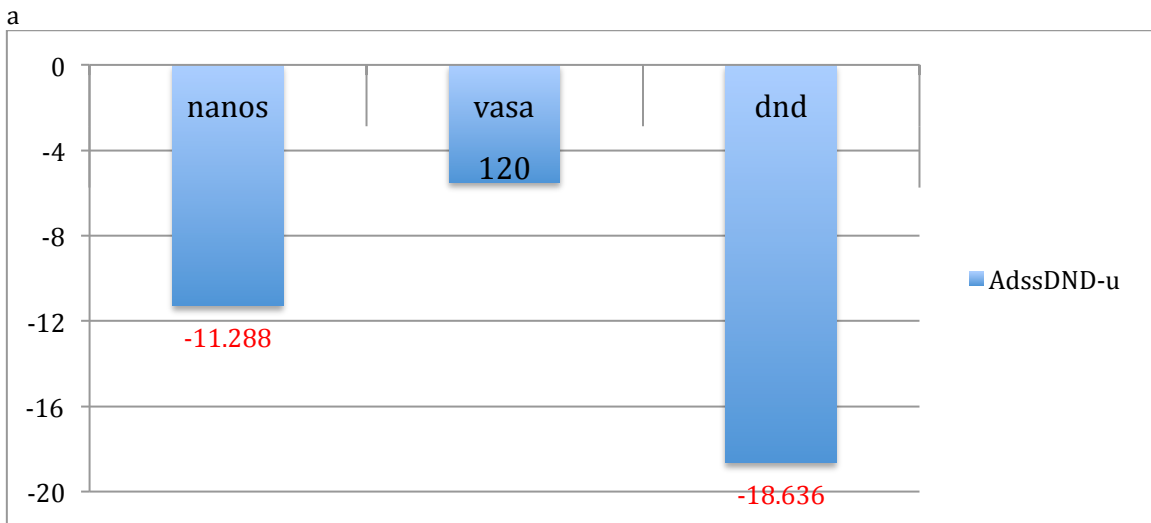
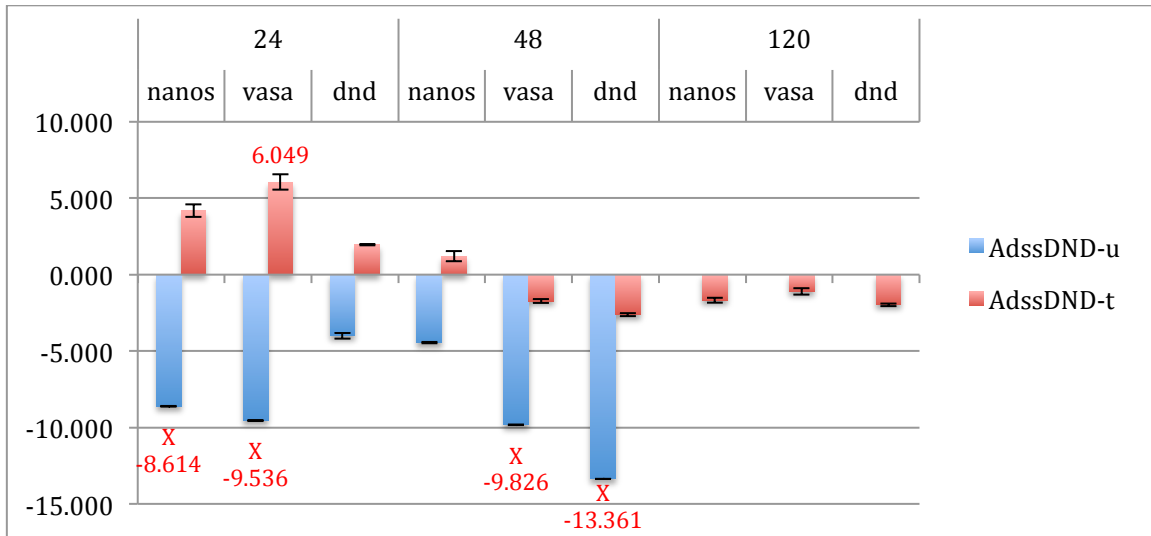

b

Figure 20. Expression of relative primordial germ cell (PGC) marker genes, *nanos*, *vasa*, and *dead end (dnd)* in treated and untreated zebrafish *adss2* gene (*Adss*) promoter fused with shRNAi targeting channel catfish *dead end* gene (DND) F1 *AdssDND* transgenic channel catfish (*Ictalurus punctatus*) embryos. Treated group were treated with 4ppt sodium chloride. (a) The samples were analyzed at 24, 48 and 120 hours post fertilization (hpf) in treated, 48 and 120 hpf in untreated. (b) The samples were analyzed at 120 hpf in untreated. Relative *nanos*, *vasa*, and *dead end (dnd)* genes expression were expressed as fold change over non-transgenic control samples at the same time point. All the red fold values numbers were significant at the level of  $p < 0.05$  using Pairwise Fixed Reallocation Randomization Test (PFRR) from REST (Relative Expression Software Tool). Red X on the SE bar indicated the relative expression between treated and control was significantly different from each other using PFRR.

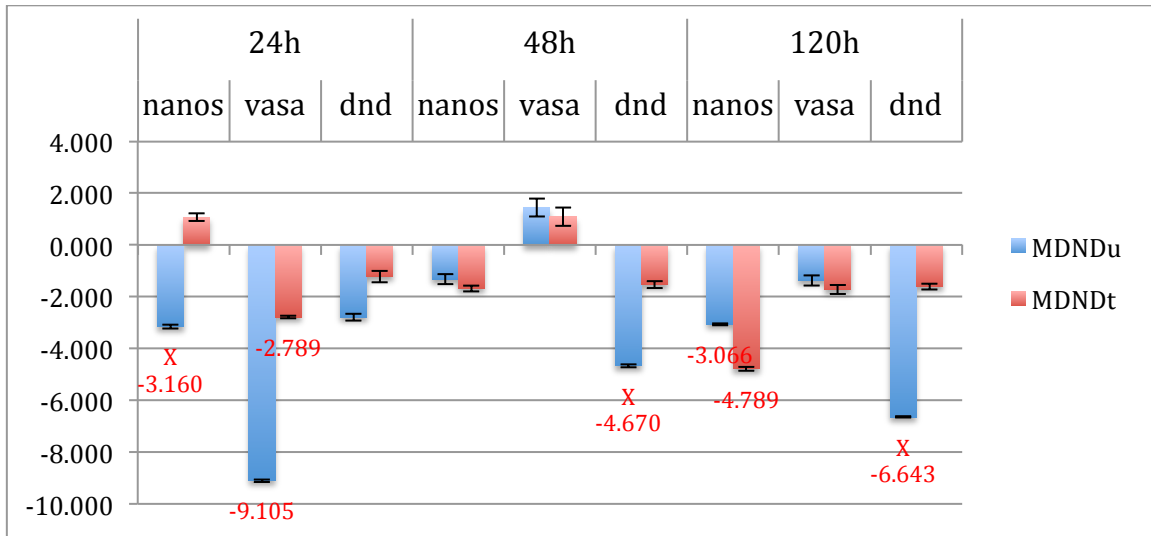

Figure 21. Expression of relative primordial germ cell (PGC) marker genes, *nanos*, *vasa*, and *dead end (dnd)* in treated and untreated yeast *mctr3* gene (M) promoter fused with shRNAi targeting channel catfish *dead end* gene (DND) F1 MDND transgenic channel catfish (*Ictalurus punctatus*) embryos. Treated group were treated with 0.1ppm copper. The samples were analyzed at 24, 48 and 120 hours post fertilization (hpf) in treated, 48 and 120 hpf in untreated. Relative *nanos*, *vasa*, and *dead end (dnd)* genes expression were expressed as fold change over non-transgenic control samples at the same time point. All the red fold values numbers shown were significant at the level of  $p < 0.05$  using Pairwise Fixed Reallocation Randomization Test (PFRR) from REST (Relative Expression Software Tool). Red X on the SE bar indicated the relative expression between treated and control was significantly different from each other using PFRR.

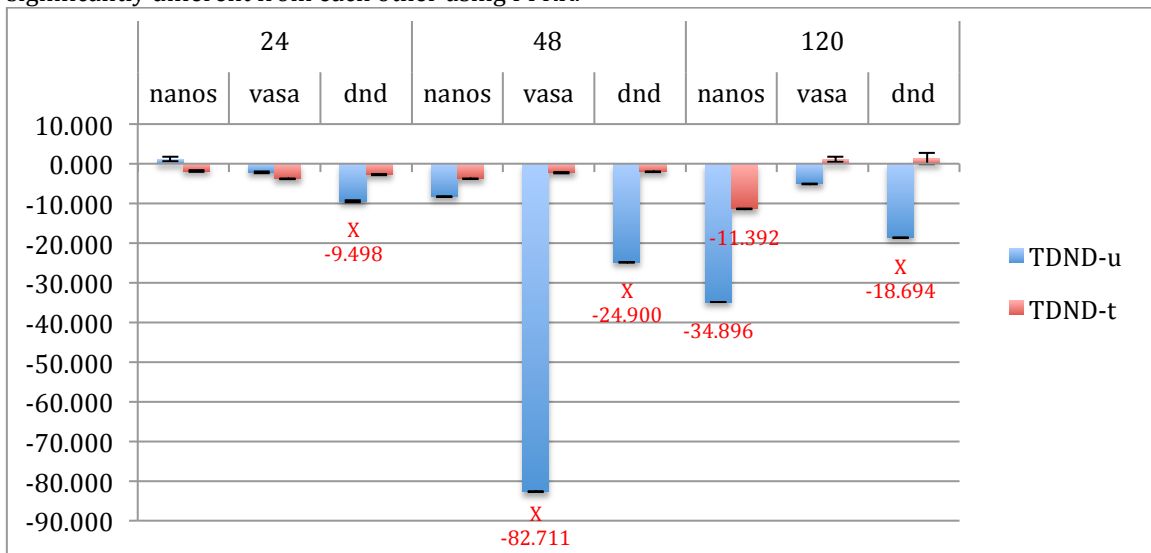

Figure 22. Expression of relative primordial germ cell (PGC) marker genes, *nanos*, *vasa*, and *dead end (dnd)* in treated and untreated salmon *transferrin* gene (T) promoter fused with shRNAi targeting channel catfish *dead end* gene (DND) F1 TDND transgenic channel catfish (*Ictalurus punctatus*) embryos. Treated group were treated with 0.1ppm cadmium chloride. The samples were analyzed at 24, 48 and 120 hours post fertilization (hpf) in treated, 48 and 120 hpf in untreated. Relative *nanos*, *vasa*, and *dead end (dnd)* genes expression were expressed as fold change over non-transgenic control samples at the same time point. All the red fold values numbers shown were significant at the level of  $p < 0.05$  using Pairwise Fixed Reallocation Randomization Test (PFRR) from REST (Relative Expression Software Tool). Red X on the SE bar indicated the relative expression between treated and control was significantly different from each other using PFRR.

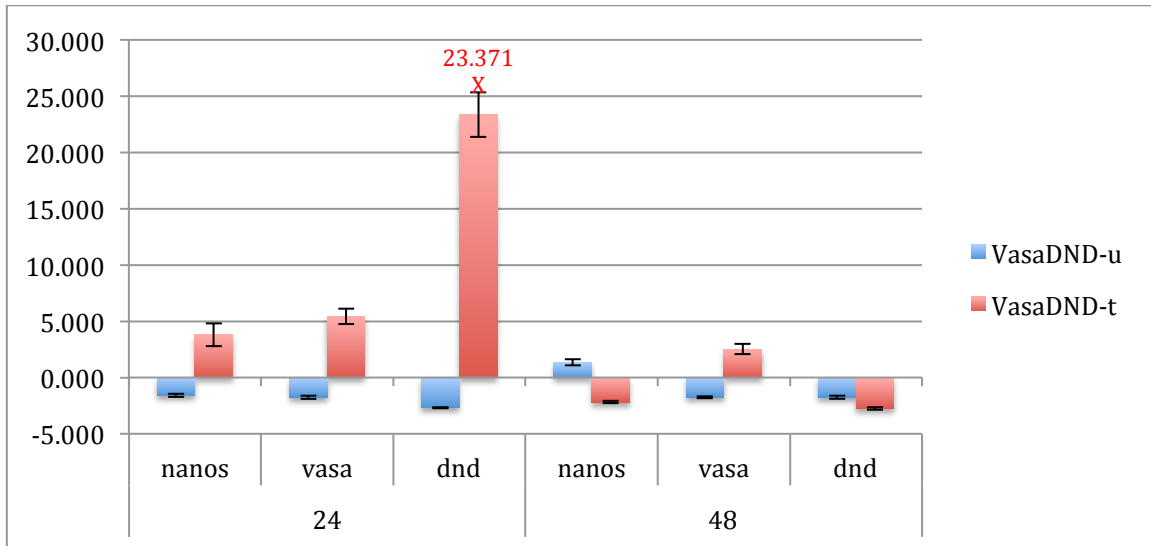

Figure 23. Expression of relative primordial germ cell (PGC) marker genes, *nanos*, *vasa*, and *dead end (dnd)* in treated and untreated channel catfish *vasa* gene (*Vasa*) promoter fused with shRNAi targeting channel catfish *dead end* gene (DND) F1 *VasaDND* transgenic channel catfish (*Ictalurus punctatus*) embryos. Treated group were treated with 0.1ppm cadmium chloride. The samples were analyzed at 24 and 48 hours post fertilization (hpf) in treated and untreated, respectively. Relative *nanos*, *vasa*, and *dead end (dnd)* genes expression were expressed as fold change over non-transgenic control samples at the same time point. All the red fold values numbers shown were significant at the level of  $p < 0.05$  using Pairwise Fixed Reallocation Randomization Test (PFRR) from REST (Relative Expression Software Tool). Red X on the SE bar indicated the relative expression between treated and control was significantly different from each other using PFRR.

### 3.3 Real-time quantitative PCR results for the F2 generation of transgenic channel catfish

Variability was observed among families for each construct in regards to downregulation of the target gene and repression of the knockdown transgene. F1 transgenic brood stocks were only 2-year-old, and only 3 families were successfully spawned to produce F2 progeny.

The relationship between untreated and salt treated AdssN2 individuals was as expected for relative expression, but not for absolute expression (Fig.24). *Nanos* was only down regulated at 48 hpf (6.6X down) and expression levels were near normal for PGC marker expression. However, salt treatment resulted in up regulation.

The TDND system worked nearly as predicted. All PGC marker genes were down regulated at 48 hpf, and *nanos* was strongly depressed at 120 hpf. *Dnd* down regulation was (21X) at 48 hpf in the untreated group (Fig.25). Significant off-target effects were observed at 48 hpf for *nanos* (29.4X) and *vasa* (40X), and at 120 hpf for *nanos* (49.3X) and *vasa* (3.6X). The cadmium chloride appeared effective for repressing the T promoter, again, as expression of treated individuals was near that of the non-transgenic control.

The one example for McDNA did not respond as hypothesized. Up regulation for *nanos* in McDNA was inconsistent in the untreated group, from -2.6X to 3.6X. Off-target effects were observed in both treated and untreated groups for *nanos* and *vasa* at multiple time points (Fig.26).

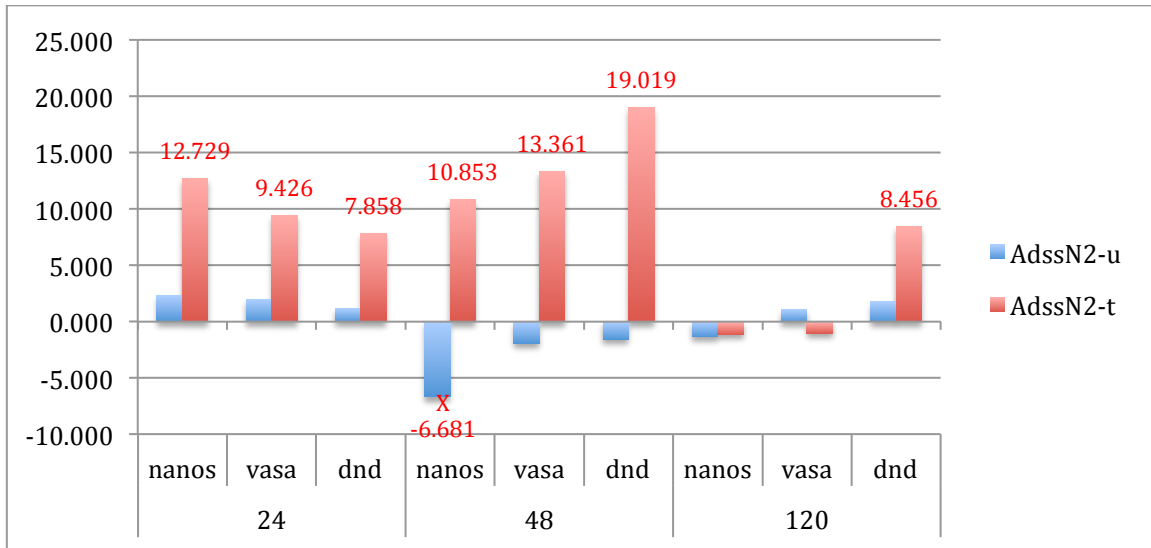

Figure 24. Expression of relative primordial germ cell (PGC) marker genes, *nanos*, *vasa*, and *dead end (dnd)* in treated and untreated zebrafish *adss2* gene (Adss) promoter fused with 3' end shRNAi targeting channel catfish *nanos* gene (N2) F2 AdssN2 transgenic channel catfish (*Ictalurus punctatus*) embryos. Treated group were treated with 4ppt sodium chloride. The samples were analyzed at 24, 48 and 120 hours post fertilization (hpf), respectively. Relative *nanos*, *vasa*, and *dead end (dnd)* genes expression were expressed as fold change over non-transgenic control samples at the same time point. All the red fold values numbers shown were significant at the level of  $p < 0.05$  using Pairwise Fixed Reallocation Randomization Test (PFRR) from REST (Relative Expression Software Tool). Red X on the SE bar indicated the relative expression between treated and control was significantly different from each other using PFRR.

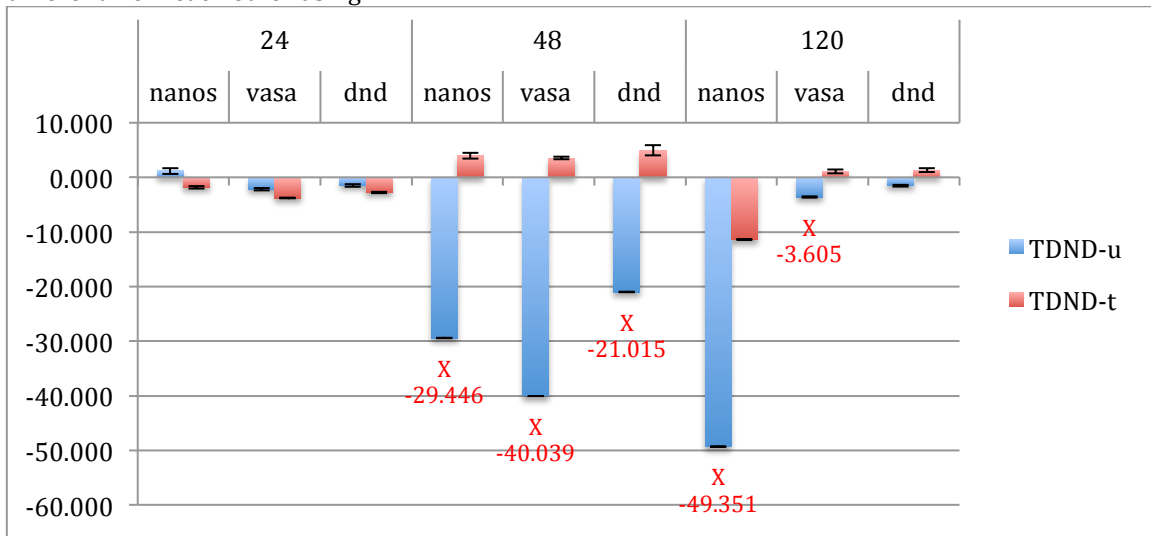

Figure 25. Expression of relative primordial germ cell (PGC) marker genes, *nanos*, *vasa*, and *dead end (dnd)* in treated and untreated salmon *transferrin* gene (T) promoter fused with shRNAi targeting channel catfish *dead end* gene (DND) F2 TDND transgenic channel catfish (*Ictalurus punctatus*) embryos. Treated group were treated with 0.1ppm cadmium chloride. The samples were analyzed at 24, 48 and 120 hours post fertilization (hpf) in treated, 48 and 120 hpf in untreated. Relative *nanos*, *vasa*, and *dead end (dnd)* genes expression were expressed as fold change over non-transgenic control samples at the same time point. All the red fold values numbers shown were significant at the level of  $p < 0.05$  using Pairwise Fixed Reallocation Randomization Test (PFRR) from REST (Relative Expression Software Tool). Red X on the SE bar indicated the relative expression between treated and control was significantly different from each other using PFRR.



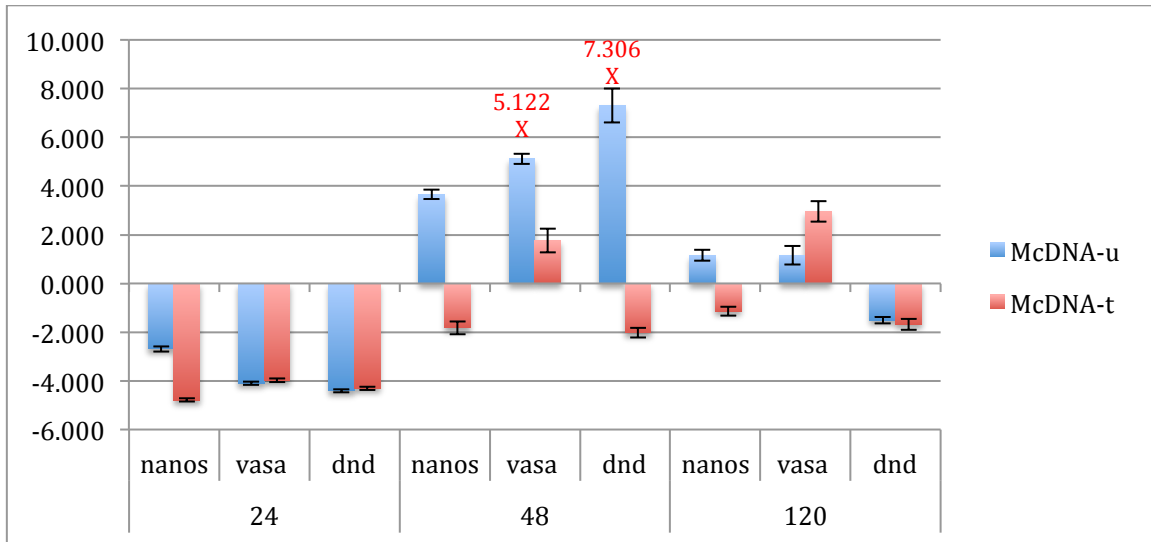

Figure 26. Expression of relative primordial germ cell (PGC) marker genes, *nanos*, *vasa*, and *dead end (dnd)* in treated and untreated yeast *mctr3* gene (M) promoter fused with cDNA of channel catfish *nanos* gene (cDNA) F2 McDNA transgenic channel catfish (*Ictalurus punctatus*) embryos. Treated group were treated with 0.1ppm copper. The samples were analyzed at 24, 48 and 120 hours post fertilization (hpf), respectively. Relative *nanos*, *vasa*, and *dead end (dnd)* genes expression were expressed as fold change over non-transgenic control samples at the same time point. All the red fold values numbers shown were significant at the level of  $p < 0.05$  using Pairwise Fixed Reallocation Randomization Test (PFRR) from REST (Relative Expression Software Tool). Red X on the SE bar indicated the relative expression between treated and control was significantly different from each other using PFRR.

### 3.4.1 GSI for 1-year-old channel catfish

One hundred 1-year-old F1 channel catfish were examined for GSI. A total of 29 of 63 males were transgenic and 10 of 37 females were transgenic (Table 1).

Transgenic group had excess males and the sex ratio, 2.9 males: 1.0 females, differed ( $P=0.037$ ) from 1:1 and to that of the non-transgenic full-siblings, 1.3:1 ( $P=0.089$ ).

After the first year of development prior to complete sexual maturity, the difference in GSI, 23.1%, between transgenic untreated ( $\bar{x}=0.039$ ) and non-transgenic male fish ( $\bar{x}=0.048$ ) was not significant ( $P>0.05$ ). Mean GSI values for 1-year-old males in transgenic and non-transgenic groups were 0.039 and 0.048 (Fig.27). There was only one individual with a GSI greater than 0.25, which was a non-transgenic individual with a GSI of 0.5.

However, the mean GSI was different for females at one year of age, with that of non-transgenic females, 0.524, larger than that of transgenic females, 0.259 (Fig.27). The largest GSI for 1-year-old transgenic females was 0.5, however, almost 50% of the non-transgenic females had ovaries that were larger than this with some double-to-triple that of the transgenic females. Three transgenic females have smaller gonads than all non-transgenic female full-siblings.

Table 1. Gonadal somatic index, GSI (= gonad weight/body weight x100), gonad weight and body weight of 1-year-old transgenic and non-transgenic full-sibling channel catfish, *Ictalurus punctatus*, grown in a 0.04-ha pond. Transgenic individuals had one of five possible constructs, M (MN1, MN2 and MDND), MctrN2 and TDND. Mctr3 (M): The yeast *ctr3* promoter (copper sensitive, regulated by MAC1 gene). Mctr3-reduced (MCTR): reduced *ctr3* gene (less sensitive to copper). Transferrin (T): The salmon *transferrin* promoter (cadmium chloride sensitive). N1: 5' end ds-shRNA targeting channel catfish *nanos* gene. N2: 3' end ds-shRNA targeting channel catfish *nanos* gene. DND: ds-shRNA targeting channel catfish *dead end* gene.

Gender	Female				Male				
Group	Transgenic			Non	Transgenic			Non	
Promoter	M	MctrN2	Sum		M	MctrN2	TDND	Sum	
Number	6	4	10	27	9	19	1	29	34
GSI	0.242	0.285	0.259	0.524	0.0472	0.0362	0	0.039	0.048
Body weight	187	238	218	288	366	228	183	269	214
Gonad weight	0.33	0.77	0.51	1.74	0.22	0.13	0	0.15	0.20

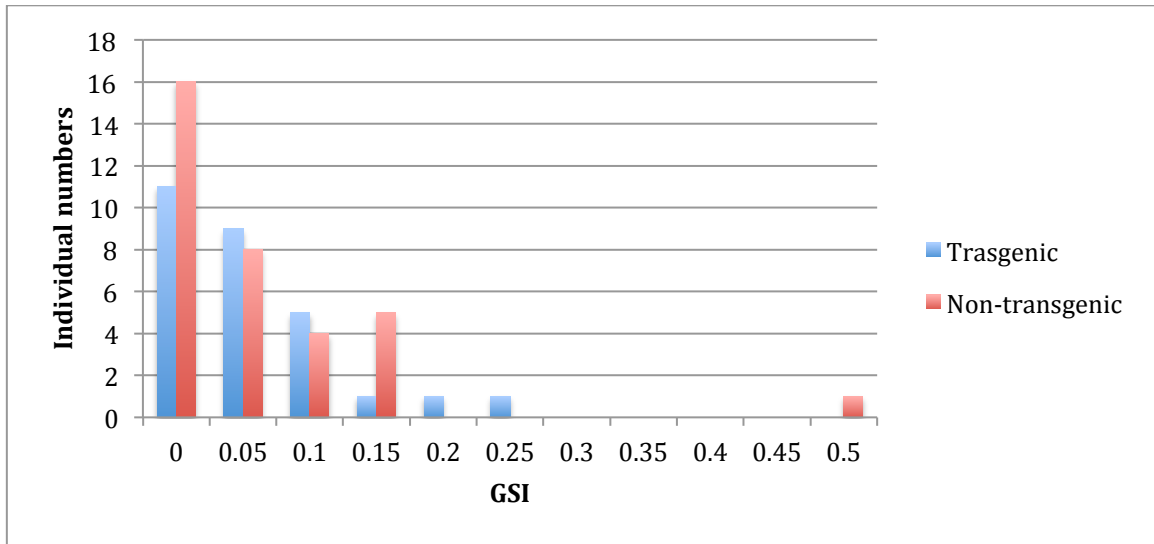

a

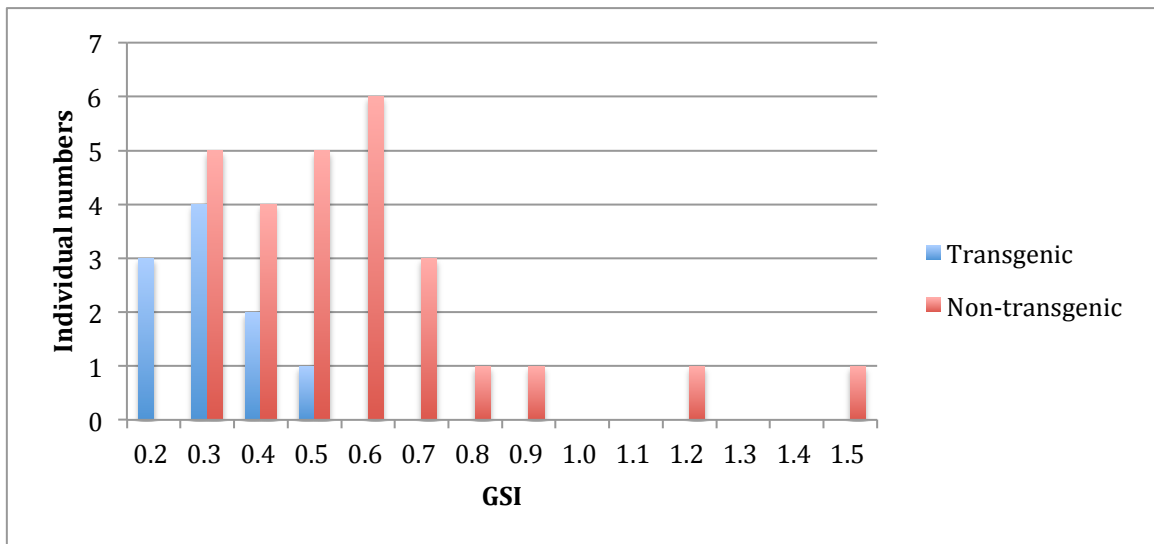

b

Figure 27. Distribution of gonadal somatic index, GSI (= gonad weight/body weight x100) of 1-year-old male (a) and female (b) transgenic and non-transgenic full-sibling channel catfish, *Ictalurus punctatus*, grown in a 0.04-ha pond. Transgenic individuals had one of five possible constructs, M (MN1, MN2 and MDND), MctrN2 and TDND. Mctr3 (M): The yeast *ctr3* promoter (copper sensitive, regulated by MAC1 gene). Mctr3-reduced (Mctr): reduced *ctr3* gene (less sensitive to copper). Transferrin (T): The salmon *transferrin* promoter (cadmium chloride sensitive). N1: 5' end ds-shRNA targeting channel catfish *nanos* gene. N2: 3' end ds-shRNA targeting channel catfish *nanos* gene. DND: ds-shRNA targeting channel catfish *dead end* gene.

### 3.4.2 GSI for 3-year-old channel catfish

Fish from the same pond were examined again when they were 3 years old. A total of 18 of 51 were transgenic males and 17 of 62 were transgenic females. Sex ratios shifted over the 2-year-period. The transgenic male: female ratio was 1.1:1.0 and different ( $P=0.05$ ) from when they were one-year-old. Sex ratio for non-transgenic full-siblings was 0.7:1.0, and although there was an observed change from majority male to majority female, the change was not significant ( $P=0.13$ ). Overall, males were disappearing from the population.

GSI differences were larger between transgenic and non-transgenic groups at 3 years of age than as 1-year-olds for both sexes. Mean GSI values for males in transgenic and non-transgenic populations were 0.044 and 0.580, while for females the values were 0.956 and 14.54, respectively (Table 2 a). Gonad development for both males and females was significantly ( $P<0.05$ ) suppressed in the transgenic untreated group (Fig. 28). Gonad size in the transgenic untreated group was 93.4% smaller than the non-transgenic group for females, and 92.3% for males.

Twenty-nine of 33 non-transgenic males had a GSI larger than all transgenic males at 3 years of age, and the four with the smallest values were equivalent to those for the four transgenic males with the largest gonads (Fig. 28). Non-transgenic females had ovaries that were 10-200X larger than their transgenic full-sibling females.

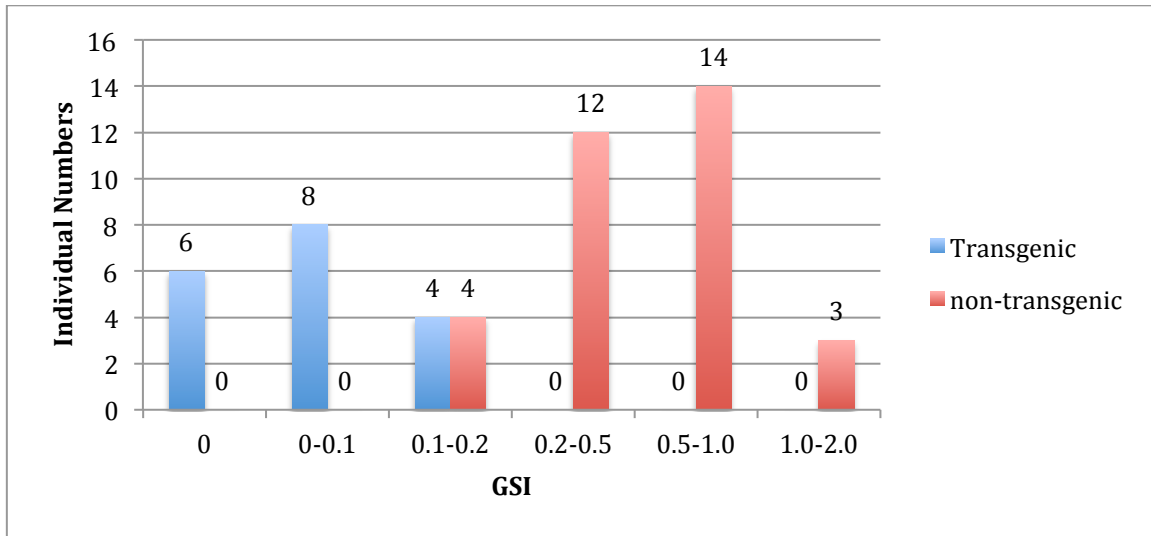

a

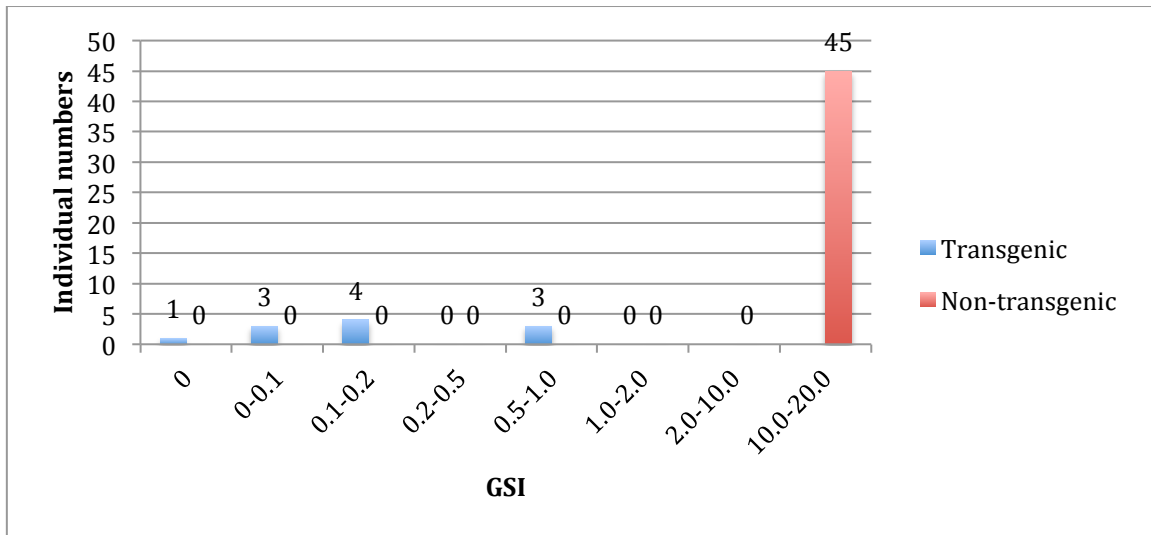

b

Figure 28. Distribution of gonadal somatic index, GSI (= gonad weight/body weight x100) of 3-year-old male (a) and female (b) transgenic and non-transgenic full-sibling channel catfish, *Ictalurus punctatus*, grown in a 0.04-ha pond. Transgenic individuals had one of five possible constructs, M (MN1, MN2 and MDND), MctrN2 and TDND. Mctr3 (M): The yeast *ctr3* promoter (copper sensitive, regulated by MAC1 gene). Mctr3-reduced (Mctr): reduced *ctr3* gene (less sensitive to copper). Transferrin (T): The salmon *transferrin* promoter (cadmium chloride sensitive). N1: 5' end ds-shRNA targeting channel catfish *nanos* gene. N2: 3' end ds-shRNA targeting channel catfish *nanos* gene. DND: ds-shRNA targeting channel catfish *dead end* gene.

### 3.4.3 Percentage of adult individuals with no gonad development in transgenic untreated group

Eight of 18 males and 6 of 17 females in the 3-year-old transgenic untreated group had no gonadal development (Table 2 a). All non-transgenic adult channel catfish had gonadal development.

### 3.4.4 Growth rate

Non-transgenic females (288g) were larger than transgenic females (218g), but non-transgenic males (214g) were smaller than transgenic males (269g) at one year of age. Transgenic females (782g) and males (884g) were smaller than non-transgenic counterparts (984g and 1254g) at three years of age, a 25.8% and 41.9% difference for females and males, respectively. For both 1-year-old and 3-year-old fish, females with M (MN1, MN2 and MDND) constructs ( $\bar{x}=767$ ) were smaller in body size than females with MctrN2 ( $\bar{x}=799$ ) construct, and males were the opposite with those with M ( $\bar{x}=933$ ) constructs larger than males with the MctrN2 ( $\bar{x}=823$ ) construct (Table 2 b). When detach gonad weight from body weight, obvious change happened for 3-year-old females, body weight difference of transgenic (774g) and non-transgenic (830g) was decreased to 7.2%.

### 3.4.5 Survival

Fish sampled at one year of age were 39% transgenic, while those sampled at three years of age were 31% transgenic. Although the observed % of transgenic individuals is decreasing, the implied survival difference was not significant ( $P=0.25$ ). As indicated above percentage of males was decreasing for both transgenic and control genotypes.

Table 2. a. Gonadal somatic index, GSI (= gonad weight/body weight x100) of 3-year-old transgenic and non-transgenic full-sibling channel catfish, *Ictalurus punctatus*, grown in a 0.04-ha pond. b. Body weight and gonad weight of 3-year-old transgenic and non-transgenic full-sibling channel catfish, *Ictalurus punctatus*, grown in a 0.04-ha pond. Transgenic individuals had one of five possible constructs, M (MN1, MN2 and MDND), MctrN2 and TDND. Mctr3 (M): The yeast *ctr3* promoter (copper sensitive, regulated by MAC1 gene). Mctr3-reduced (Mctr): reduced *ctr3* gene (less sensitive to copper). Transferrin (T): The salmon transferrin promoter (cadmium chloride sensitive). N1: 5' end ds-shRNA targeting channel catfish *nanos* gene. N2: 3' end ds-shRNA targeting channel catfish *nanos* gene. DND: ds-shRNA targeting channel catfish *dead end* gene. All weights measured in gram (g). No gonad reflects percentage of individuals without gonad development.  $\rho$  is correlation coefficient of body weight and gonad weight in same construct group.

	Male				Female			
	N	GSI	No gonad	Range	N	GSI	No gonad	Range
MN1	4	0.059	50%	0-0.188	4	0.587	0%	0.313-0.814
MN2	5	0.046	20%	0-0.118	4	1.379	50%	0-5.067
MDND	1	0.169	N/A	0.169	1	0	N/A	0
MctrN2	8	0.022	62.5%	0-0.135	8	1.049	37.5%	0-4.486
Sum transgenic	18	0.044	44.4%	0-0.188	17	0.956	35.3%	0-5.067
Non transgenic	33	0.580	0%	0.138-1.120	45	14.540	0%	11.348-19.639

a



	Male					Female				
	N	Body weight	Gonad weight	$\rho$	BW range	N	Body weight	Gonad weight	$\rho$	BW range
MN1	4	808	0.73	0.954	440-1330	4	950	5.75	0.823	640-1200
MN2	5	864	0.40	-0.098	530-1130	4	645	10.25	0.632	480-750
MDND	1	1780	3.0	N/A	1780	1	520	0	N/A	520
MctrN2	8	823	0.29	0.878	540-1480	8	799	9.10	0.343	580-1170
Sum transgenic	18	884	0.58	0.861	440-1780	17	782	8.05	0.278	480-1200
Non transgenic	33	1254	7.83	0.693	480-1710	45	984	143.71	0.814	630-1570

b

### 3.5 Spawning evaluation

From 2012-2015, 239 P1 females electroporated with the sterilization constructs as one-cell embryos were injected with LHRHa to induce spawning or were evaluated for spawning readiness. A total of 140 were from the untreated group and 99 were from the treated group (Table 3). The overall spawning rates for pooled untreated group and treated group were 56% to 88%, the observed difference was significant ( $P < 0.05$ ). Fish from 6, AdssN1, AdssN2, RMDND, McDNA, MctrN2 and MctrcDNA, of 28 constructs in the untreated group had spawning rates lower than 50%; while females from 11 of 28 constructs in the treated group had 100% spawning rates. There were significant differences ( $P < 0.05$ ) between treated and untreated groups of AdssN2 and MctrN2.

When spawning rates in untreated groups and treated groups were pooled by promoters, fish with Adss and Mctr promoters had significant differences ( $p < 0.05$ ) between transgenic treated and untreated groups. The ratio of treated spawning rate/ untreated spawning rate was 1.7-2.0 for fish with those 4 promoters (Table 4).

When pooling by Knock down strategy, spawning rates for untreated and treated groups of N2 and cDNA had the best knock down/repress efficiency ( $P < 0.05$ ). With a 1.24:1 ratio of spawning rates between knockdown and repressed AdssN1, AdssN2, RMDND, McDNA, MctrN2 and MctrcDNA groups, N1 appeared to be most inefficient knock down strategy (Table 4).

Table 3. Spawning rates of P1 female channel catfish (*Ictalurus punctatus*) electroporated with constructs designed to disrupt primordial germ cell migration and then either untreated or treated with compounds expected to repress the expression of the transgene. ADSS: zebrafish *adss2* promoter (salt sensitive). Racemase (RM): zebrafish *racemase* promoter (salt sensitive). Mctr3 (M): The yeast *ctr3* promoter (copper sensitive, regulated by MAC1 gene). Mctr3-reduced (MCTR): reduced *ctr3* gene (less sensitive to copper). Transferrin (T): The salmon *transferrin* promoter (cadmium chloride sensitive). Nanos: modified tet-off system using the catfish *nanos* promoter. (Doxycycline sensitive). Vasa: modified tet-off system using the catfish *vasa* promoter (Doxycycline sensitive). N1: 5' end ds-shRNA targeting channel catfish *nanos* gene. N2: 3' end ds-shRNA targeting channel catfish *nanos* gene. cDNA: full length cDNA sequence of channel catfish *nanos* gene. DND: ds-shRNA targeting channel catfish *dead end* gene. Asterisk behind the construct name means the difference untreated and treated spawning rates of fish possessed that construct is significant (P<0.05).

	Untreated			Treated		
	Spawned	Total	%	Spawned	Total	%
AdssN1	1	4	25	0	0	0
AdssN2*	2	8	25	4	4	100
AdsscDNA	8	13	62	8	8	100
AdssDND	6	8	75	5	5	100
RMN1	7	9	78	8	8	100
RMN2	6	8	75	8	10	80
RMcDNA	2	3	67	3	3	100
RMDND	2	5	40	2	3	67
MN1	7	9	78	2	3	67
MN2	6	9	67	10	10	100
McDNA*	0	2	0	5	5	100
MDND	3	6	50	5	7	71
MctrN1	5	7	71	3	4	75
MctrN2*	3	10	30	7	8	88
MctrcDNA	2	7	29	0	0	0
MctrDND	4	6	67	2	3	67
TN1	2	4	50	1	2	50
TN2	2	4	50	3	3	100
TcDNA	3	4	75	1	1	100
TDND	5	9	56	4	5	80
NanosN1	0	0	0	0	0	0
NanosN2*	0	1	0	2	2	100
NanoscDNA	1	1	100	0	1	0
NanosDND	0	1	0	0	0	0
VasaN1	0	0	0	0	0	0
VasaN2	0	1	0	0	0	0
VasacDNA	0	0	0	0	0	0
VasaDND	1	1	100	4	4	100
Total	78	140	56	87	99	88

Table 4. Spawning rates of P1 female channel catfish (*Ictalurus punctatus*) electroporated with constructs designed to disrupt primordial germ cell migration and then either untreated or treated with compounds expected to repress the expression of the transgene. Groups are pooled by 7 promoters and 4 knock down strategies. ADSS: zebrafish ADSS2 promoter (salt sensitive). Racemase (RM): zebrafish ADSS2 promoter (salt sensitive). *Ctr3* (M): The yeast *ctr3* promoter (copper sensitive, regulated by MAC1 gene). *Ctr3-reduced* (Mctr): reduced *ctr3* gene (less sensitive to copper). Transferrin (T): The salmon transferrin promoter (cadmium chloride sensitive). Nanos: modified tet-off system using the catfish *nanos* promoter. (doxycycline sensitive). Vasa: modified tet-off system using the catfish *vasa* promoter (doxycycline sensitive). N1: 5' end ds-shRNA targeting channel catfish *nanos* gene. N2: 3' end ds-shRNA targeting channel catfish *nanos* gene. cDNA: full length cDNA sequence of channel catfish *nanos* gene. DND: ds-shRNA targeting channel catfish *dead end* gene. Ratio T/U: treated spawning rate/ untreated spawning rate. An asterisk behind the RNAi construct name means the difference between the spawning rates of fish untreated and treated for a RNAi construct was significant (P<0.05).

	Untreated			Treated			Ratio of T/U
	Spawned	Total	%	Spawned	Total	%	
Adss*	17	33	52%	17	17	100%	1.94
Rm	17	25	68%	21	24	88%	1.29
M	16	26	62%	22	25	88%	1.43
Mctr*	14	30	47%	12	15	80%	1.71
T	12	21	57%	9	11	82%	1.43
Nanos	1	3	33%	2	3	67%	2.00
Vasa	1	2	50%	4	4	100%	2.00
N1	22	33	67%	14	17	82%	1.24
N2*	19	41	46%	34	37	92%	1.98
cDNA*	16	30	53%	17	18	94%	1.77
DND	21	36	58%	22	27	81%	1.40

#### 4. Discussion

Knockdown constructs, shRNAi and cDNA, targeting the PGC genes, *nanos* and *dnd*, which play important roles in PGC migration were electroporated into channel catfish to achieve transgenic sterilization by inhibiting gonad and gamete development. These constructs were designed to be repressed by application of various compounds to accomplish repressible transgenic sterilization. Gene expression of PGC marker genes during the early development of P1 electroporated individuals that were either untreated or untreated (Su, 2012, Su et al. 2015) and of F1 and F2 transgenic individuals in the current study indicated that the sterilization constructs were downregulating the key PGC genes, and that the repression could be successful. Spawning data on P1 treated and untreated brood stock and a limited number of F1 brood stock indicated that the repressible system was partially, if not fully achieved. Additionally, many complementary off-target effects on the related PGC genes were observed. The essential 100% knockout of gonadal development in F1 transgenic males and females was achieved. However, the transgenic F1 exhibited the undesirable pleiotropic effects of decreased growth rates and probable reduced survival.

From 24 to 120 hpf, levels of *nanos* mRNA dropped naturally, *dead end* dropped slightly faster than *nanos*, and *vasa* was dramatically lower, at 120 hpf compared to 24 hpf in normal, non-transgenic embryos. Either the expression of mRNA of those 3 PGC migration marker genes were down regulated naturally or there was maternally derived mRNA of those marker genes in the early phase of embryonic development, which was being degraded later in embryogenesis. However, maternally derived *nanos* mRNA in zebrafish degrades rapidly before gastrulation (Kopranner et al. 2001), and Xu et al (2014) have shown that during embryogenesis in Asian seabass, , the *vasa* transcript is high in early stages, and persists at a reduced and detectable level in late stages, supporting the premise that the decreases in the *nanos*, *vasa*, and *dead end* mRNA levels in channel catfish are due to natural and transgenic downregulation, and not just degradation.

These observations on embryonic expression levels of *nanos*, *vasa*, and *dead end* mRNA might have implications for different knockdown strategies to prevent

migration of PGCs and their potential success in channel catfish and other fish species (Su et al. 2015). Knockdown efficiency might be altered by the factors that are naturally occurring for decreased mRNA levels of the PGC migration related genes.. A more detailed study of the expression level of these three mRNAs in embryonic development of channel catfish might be beneficial for identifying the transgenic sterilization constructs with the best probability of success and further refinement of the repressible transgenic sterilization systems.

Previous data on P1 embryos have shown that zebrafish, salmon, channel catfish and yeast promoters were able to drive transcription in channel catfish and common carp embryos that had been electroporated with the knockdown constructs and likely had large copy numbers in their cytoplasm (Su 2012, Su et al. 2014, 2015). The expression data on the PGC targets of the F1 transgenic embryos that had integrated copies of the transgenic sterilization constructs was in general agreement with the results from the P1.

Overall, the series of constructs designed to cleave a 5' mRNA target of channel catfish *nanos* (N1) exhibited large variability in downregulation and subsequent repression. However, the knockdown of *nanos* was consistent in MctrN1 at all 3 time-points that were measured during embryonic development. Although some of these constructs appeared promising for terminating PGC migration, a perfectly accurate prediction of their potential usefulness is not possible, as it is not yet known when exactly in development are the critical time points to disrupt PGC migration, and the necessary initiation of and duration of downregulation to prevent PGCs from reaching the genital ridge.

All of the constructs with 3' shRNA targeting channel catfish *nanos gene* (N2) were able to knock down the expression level of *nanos*, and more consistently than N1. Targeting the 3' end of *nanos* appeared more effective for downregulation than the 5' end. AdssN2, RMN2, MN2, MctrN2 and TN2 appeared to have more effective knockdown than the tet-off system, NanosN2.

One approach to knockdown of the native *nanos* mRNA was the overexpression of channel catfish *nanos* cDNA. RMcDNA, McDNA and TcDNA upregulated *nanos*, but AdsscDNA had the opposite effect on *nanos* expression. *Dead end* was effectively

knocked down with AdssDND, MDND and TDND by targeting the 5' sequence of channel catfish *dead end* (DND) with shRNAi, but VasaDND, a tet-off system driven by the native channel catfish *vasa* promoter was relatively ineffective compared to the other constructs. Knockdown of *nanos* and *dnd* mRNA expression by constructs using N2 and DND produced results that were the most like the expectation, while N1 seemed relatively inconsistent for *nanos* knock down. In general, cDNA constructs increased expression *nanos*, which still might have the desired effect of preventing the functionality of the mRNA.

Usually, knockdown was observed at some but not all embryonic stages evaluated. It is not known when is the critical period of PGC marker gene knockdown that ensures that the PGC does not reach the genital ridge or dies. Based on our results, it appears it is not necessary to knockdown the PGC gene expression during all of embryogenesis to achieve sterilization. However, further research is necessary to confirm these apparent results.

The downregulation in the F1 transgenic embryos was sometimes similar, but often greater than their parents (Su 2012, Su et al. 2015) that were exposed to the constructs via electroporation the previous generation when they were embryos. There were a couple of exceptions as in the parental generation the overexpression of the *nanos* cDNA was dramatically higher than in the F1 embryos. One odd consistency was that MN1 was up rather than downregulated *nanos* in both the P1 and F1 generations. For the shRNAi constructs, the integrated transgenes were more effective than the presumed concatamers expressing in the cytoplasm of the P1 embryos. These results also show that although data on P1 for embryonic traits generated from exposure to transgenes has some value and relationship to what might be obtained in integrated F1 individuals, the relationship may not be perfectly predictive. Results for P1 and F1 common carp exposed or containing a shRNAi targeting aromatase were contradictory (Zhang 2016). In this case, usefulness of the P1 data may be further compromised as the trait in question, gender, is determined several days after hatching.

Strong off-target effects for related PGC genes were common in the P1 generation (Su 2012, Su et al. 2015) and in the current study. The off-target effects might be

cause by mismatch of siRNA (Saxena et al. 2003, Scacheri et al. 2004). Also there might be strong genetic interaction effects among *nanos*, *vasa* and *dead end*, such as *dnd* protein acts to counteract the inhibitory function of several miRNAs, thereby allowing the expression of PGC specific proteins such as *nanos* and *tdrd7* (Slanchev et al. 2009, kedde et al. 2007), or in *Drosophila*, the *vasa* gene encodes an ATP-dependent RNA helicase of the DEAD-box family and is required for promoting translation of at least two known mRNAs, *nanos* and *gurken* (Raz 2000). If the off-target effects were restricted to PGC migration loci, they may contribute to sterility.

In spite of some strong off-target effects or failed repression at a few time points in particular samples, the repression was successful in most cases. Repression of sterilization constructs was variable, sometimes not complete, but often almost exactly as originally hypothesized. Additional research is needed regarding the minimum doses needed to repress the knockdown constructs. This is especially important as if the promoters are too sensitive and can be repressed at low but naturally found levels of copper, cadmium or salt, escaped transgenic channel catfish could establish in the wild, negating the usefulness of the sterilization constructs evaluated in the current study. The repression of the promoters was more consistent and effective in the F1 generation compared to the P1 generation.

Only 3 F2 families were produced. As seen in the two previous generations, results were variable. The knockdown and repression in TDND and McDNA were similar as the same constructs F1. TDND knockdown and repression was especially as planned at 48 hpf. However, salt treatment for the one F2 family transgenic for AdssN2 resulted in strong upregulation for *nanos* and *vasa* at 3 time points and for *dnd* at 120 hpf rather than repressing the Adss promoter.

GSI is a tool for measuring the sexual maturity of animals since it measures ovarian and testicular development (Hunter and Macewicz. 2001). Testicular development is minimal in young catfish males, and not surprisingly, mean GSI was not different between transgenic and non-transgenic fish in 1-year-old males. By the time the males reached 3 years of age, GSI of non-transgenic males was much larger than that of the control males. In females, mean GSI was smaller for transgenic



individuals compared to non-transgenic in 1-year-old fish, and the difference was much larger when they were 3-years-old. The distribution of GSI was highly suggestive that 100% of transgenic males and females, which represented 4 families for constructs of MN1, MN2, MDND and MctrN2, were sterile. This is the level of sterilization essential for preventing transgene flow into native populations in the event of escape of transgenic catfish. A noticeable fact is that beside of all adult transgenics had repressed or null germline development, forty % of them had no gonadal development. *Although other studies indicate that expression of clift, dsh-2, sdf-1 and etc. are responsible for gonad development, little is known about the precursors of the gonad in channel catfish. Does our work indicate that nanos, deadend and vasa also have a role in gonad development or are these constructs causing more off-target effects, especially since the knockdown constructs may continuously expressing after the embryonic development stages.*

Unfortunately, the families with the confirmed depressed or absent gonad development also had negative pleiotropic effects for growth and survival. One-year-old transgenic females were smaller than full-sibling controls. In the case of males, for which controls do not have much gonadal development at one year, the transgenic males were actually had observed mean body weight higher than full-sibling non-transgenic controls. However, when reached 3-year-old and approximately one kg in size, a typical harvest weight, transgenic males were approximately 41.9% smaller than controls. Transgenic females were 25% smaller than controls with gonad, and only 7% smaller than controls when gonad weight was detached from body weight. The stocking density was relatively low and growth was relatively slow in this pond, thus these growth differences need to be confirmed in various culture environments because genotype-environment interactions are common in transgenic comparisons (Dunham 2011, Abass et al 2016).

Although survival was not statistically different between transgenic and control channel catfish, sex ratios were changing over time indicating lower survival for transgenic males. Sex hormones, especially testosterone for male, are obviously necessary for aggressive behavior in catfish (Tucker and Hargreaves. 2004). With null or limited testis development and sexual hormone secretion, adult male and

female channel catfish would likely be less aggressive and competitive, providing one possible explanation for decreased growth and survival. If the lack of essential hormones can be proved responsible for the decreasing of growth and survival, culture transgenic and non-transgenic fish separately might be a solution to minimize the competition pressure for transgenic fish.

Both sterilization and repression must be achieved for application of the functional repressible transgenic system. Evidence from the P1 generation for which embryos were exposed to sterilization constructs, but did not necessarily integrate them was encouraging as embryos treated with the repressor compounds had higher spawning and maturity rates than embryos not exposed to the repressors. Assuming that the larger the difference between treated and untreated P1 for spawning the greater the potential of a fully functional repressible transgenic sterilization system, Adss, Mctr, Nanos and Vasa appeared to be the most promising promoters, although replication was minimal for Vasa and Nanos, and N2 and cDNA the most promising knockdown strategies. In regards to the results from specific promoter and knockdown combinations, AdssN2, McDNA, MctrN2, TN2 and NanosN2 (minimal replication, but consistent with other unpublished results) had the lowest spawning rates of the untreated fish coupled with high spawning rates for the treated/repressed brood stock.

## **5.Conclusion**

Novel constructs designed to knockdown PGC marker gene expression acted in a dominant fashion, as expected, significantly altered expression of the PGC genes and appeared to produce 100% sterility in F1 transgenic channel catfish containing these constructs. Spawning and sexual maturity rates of P1 individuals exposed to the PGC knockdown constructs and then either treated or not treated with the repressor compounds, sodium chloride, copper sulfate, cadmium chloride or doxycycline as well as supporting gene expression data suggest that these constructs are repressible, which would allow the application of repressible transgenic sterilization systems. Additional confirmation of these initial positive results is needed for F1 brood stock that are treated or not treated with the

repressor compounds during embryonic development as well as evidence of sterilization in the F2 generation. However, these systems may have limited application if the negative pleiotropic effects on growth and survival are not overcome. This decrease in growth and survival needs to be examined in a variety of culture environments. The intent is to couple this technology with transgenesis for performance traits. Channel catfish transgenic for both growth hormone gene and the PGC knockdown genes may be able to compensate for the negative pleiotropic effects. However, it is not logical that such compensation would be expected for fish transgenic for traits that are not growth related. With these possible shortcomings, negative pleiotropic effects, to overcome, it becomes more important to compare repressible transgenic sterilization systems with new promising alternatives such as gene editing of reproductive hormone genes coupled with hormone therapy (Qin et al. 2015) or application of CRISPRi (Qi et al. 2013).

## References

- Abass, N.Y., Dunham, R.A., et al. 2016. Genotype-environment interactions for survival and growth rate at varying salinity for channel catfish, albino catfish, and transgenic channel catfish by cDNA growth hormone (GH). *Aquaculture*. DOI:10.13140/RG.2.1.4220.3286
- Armstrong, J.B., Duhon, S.T., and Malacinski, G.M. 1989. Raising the axolotl in captivity. In J. B. Armstrong and G. M. Malacinski (eds.) *Developmental Biology of the Axolotl*. New York: Oxford University Press, pp. 220-227.
- Braat, A. K., van de Water, S., Korving, J., Zivkovic, D. 2001. A zebrafish vasa morphant abolishes Vasa protein but does not affect the establishment of the germline. *Genesis* 30(3): 183-185. DOI: 10.1002/gene.1060
- Bart, A. N., Dunham, R. A., 1990. Factors Affecting Survival of Channel Catfish after Surgical Removal of Testes. *The Progressive Fish-Culturist*. Volume 52, Issue 4, 1990. DOI:10.1577/1548-8640
- Carginale, V., Capasso, C., Scudierob, R., Parisia, E. 2002. Identification of cadmium-sensitive genes in the Antarctic fish *Chionodraco hamatus* by messenger RNA differential display. *Gene*, Volume 299, Issues 1-2, 16 October 2002, Pages 117-124. DOI:10.1016/S0378-1119(02)01020-X
- Cheng, Q. 2013. The Effect of Diet and the Masou Salmon Delta5-Desaturase Transgene on Delta6-Desaturase and Stearoyl-CoA Desaturase Gene Expression and N-3 Fatty Acid Level in Common Carp (*Cyprinus carpio*) Thesis. *Fisheries and Allied Aquacultures*. Auburn University. 2013-07-10.
- Daneholt, Bertil. 2007 "Advanced Information: RNA interference". The Nobel Prize in Physiology or Medicine 2006. Archived from the original on 2007-01-20. Retrieved 2007-01-25.
- Schlenk, D., Colley, W. C., El-Alfy, A., Kirby, R., Griffin, R.B. 2000. Effects of the Oxidant Potassium Permanganate on the Expression of Gill Metallothionein mRNA and Its Relationship to Sublethal Whole Animal Endpoints in Channel Catfish. *Toxicol. Sci.* (2000) 54 (1): 177-182 doi:10.1093/toxsci/54.1.177
- Devlin, R.H., Sundström, L.F. and Leggatt, R.A. (2015). "Assessing ecological and evolutionary consequences of growth-accelerated genetically engineered fishes". *BioScience* 65 (7): 685-700.
- Dunham, R.A., Chen, T.T., Powers, D.A., Nichols, A., Argue, B., and Chitmanat, C., 1995. Predator avoidance, spawning, and foraging ability of transgenic channel catfish with rainbow trout growth hormone gene. In: *Biotechnology Risk Assessment: Proceedings of the Biotechnology Risk Assessment Symposium*, June 6-8, 1995. (Eds. M. Levin, C. Grim and J.S. Angle). *TechniGraphix*, Reston,

VA. Pp. 127-139.

- Dunham, R. A., Warr, G., Nichols, A., Duncan, P.L., Argue, B., Middleton, D., and Liu, Z., 2002. Enhanced bacterial disease resistance of transgenic channel catfish, *Ictalurus punctatus*, possessing cecropin genes. *Marine Biotechnology* 4:338-344
- Dunham, R.A., 2011. Aquaculture and Fisheries Biotechnology: Genetic Approaches, 2nd ed. *CABI Publishing, Cambridge, MA, USA*
- FAO (2012). The State of World Fisheries and Aquaculture 2012: FAO. Online resource: [www.fao.org/docrep/016/i2727e/i2727e.pdf](http://www.fao.org/docrep/016/i2727e/i2727e.pdf)
- Fan, L., Moon, J., Wong, T.T., Crodian, J., & Collodi, P. 2008. Zebrafish Primordial Germ Cell Cultures Derived from *vasa::RFP* Transgenic Embryos. *Stem Cells and Development*, 17(3), 585–597. <http://doi.org/10.1089/scd.2007.0178>
- Fire, A., Xu, S., Montgomery, M. K., Kostas, S. A., Driver, S. E., Mello, C. C. 1997. Potent and specific genetic interference by double-stranded RNA in *Caenorhabditis elegans*. *Nature* 391, 806-811 (19 February 1998) Doi:10.1038/35888
- Gavis, E.R., Lunsford, L., Bergsten, S.E., Lehmann, R. 1996. A conserved 90 nucleotide element mediates translational repression of nanos RNA. *Development*. 1996 Sep;122(9):2791-800.
- Gibbs, P. D., and Schmale, M. C. 2000. GFP as a Genetic Marker Scorable Throughout the Life Cycle of Transgenic Zebra Fish. *Mar Biotechnol.* 2(2):107-125.
- Gregory, R., Chendrimada, T., Shiekhattar, R. 2006. "MicroRNA biogenesis: isolation and characterization of the microprocessor complex". *Methods Mol Biol* 342: 33–47. doi:10.1385/1-59745-123-1:33
- Hanson, T., Site, D. 2015. 2014 Catfish Industry Review and 2015 Outlook. *2014 U.S catfish database*.
- Herpin, A., Rohr, S., Riedel, D., Kluever, N., Raz, E., Schartl, M. 2007. Specification of primordial germ cells in medaka (*Oryzias latipes*). *BMC Dev Biol.* 2007;7:3. DOI: 10.1186/1471-213X-7-3
- Hunter, J.R. and Macewicz, B.J. (2001). Improving the accuracy and precision of reproductive information used in fisheries: modern approaches to assess maturity and fecundity of warm- and cold-water fish squids. *Fishery bulletin*, 90(1): 101-128.
- Kazuyuki, Hoshijima. Shigehisa, Hirose. 2007. Expression of endocrine genes in zebrafish larvae in response to environmental salinity. *J Endocrinol* 193 (3) 481-491, doi: 10.1677/JOE-07-0003

- Kedde, M., Strasser, M. J., Boldajipour, B., Vrieling, J.A., Slanchev, K., le Sage, C., Nagel, R., Voorhoeve, P.M., van Duijse, J., Orom, U.A., Lund, A.H., Perrakis, A., Raz, E., Agami, R. 2007. RNA-binding protein Dnd1 inhibits microRNA access to target mRNA *Cell*, 131 (2007), pp. 1273–1286. DOI:10.1016/j.cell.2007.11.034
- Köprunner, M., Thisse, C., Thisse, B., Raz, E. 2001. A zebrafish nanos-related gene is essential for the development of primordial germ cells. *Genes & Development*. 2001; 15(21): 2877-2885. DOI: 10.1101/gad.212401.
- Labbe S, et al. (1997) Copper-specific transcriptional repression of yeast genes encoding critical components in the copper transport pathway. *J Biol Chem* 272(25):15951-8 DOI: 10.1074/jbc.272.25.15951
- Mair, G. C., Nam, Y. K., Solar, I. 2007. Environmental risk assessment of genetically modified organisms, Volume 3. Methodologies for transgenic fish. *School of Biological Sciences, Flinders University, GPO Box 2100, Adelaide, SA 5001, Australia*. DOI: 10.1079/9781845932961.0209
- Molyneaux, K., Wylie, C. 2004. Primordial germ cell migration. *Int J Dev Biol*. 2004;48(5-6):537-44. DOI: 10.1387/ijdb.041833km
- Murata, Y., Wharton, P.R. 1995. Binding of pumilio to maternal hunchback mRNA is required for posterior patterning in drosophila embryos. *Cell*. Volume 80, Issue 5, p747–756, 10 March 1995. DOI:http://dx.doi.org/10.1016/0092-8674(95)90353-4
- National research council, 2002. Animal biotechnology: Scientific Concerns. NRC, Washington, D.C. ([www.nap.edu](http://www.nap.edu))
- NASS 2012. Census of Aquaculture (2012), Volume 3, Special Studies, Part 2. *USDA Census of Aquaculture*. Electronic version available at [www.agcensus.usda.gov/Publications](http://www.agcensus.usda.gov/Publications).
- Pfaffl, M. W., Horgan, G. W., Dempfle, L.. 2002. Relative Expression Software Tool (REST) for Group-Wise Comparison and Statistical Analysis of Relative Expression Results in Real-Time PCR. *Nucleic Acids Res* 30, no. 9.
- Prelich, G. (2012). Gene Overexpression: Uses, Mechanisms, and Interpretation. *Genetics*, 190(3), 841–854. <http://doi.org/10.1534/genetics.111.136911>
- Qi, L. S., Larson, M. H., Gilbert, L. A., Doudna, J. A., Weissman, J. S., Arkin, A. P., & Lim, W. A. (2013). Repurposing CRISPR as an RNA-Guided Platform for Sequence-Specific Control of Gene Expression. *Cell*, 152(5), 1173–1183. <http://doi.org/10.1016/j.cell.2013.02.022>

- Rasmussen, R.S. and Morrissey, M. T. (2007). "Biotechnology in aquaculture: transgenics and polyploidy". *Comprehensive Reviews in Food Science and Food Safety* 6 (1): 2–16.
- Raz, E. (2000). The function and regulation of vasa-like genes in germ-cell development. *Genome Biology*, 1(3), reviews1017.1–reviews1017.6.
- Saito, T., Fujimoto, T., Maegawa, S., Inoue, K., Tanaka, M., Arai, K., Yamaha, E. 2006. Visualization of primordial germ cells in vivo using GFP-nos1 3'UTR mRNA. *Int J Dev Biol.* 2006;50:691–699. DOI: 10.1387/ijdb.062143ts
- Satyajit, S., Vidyarthi, A.S., Prasad, D. (2014). "RNA interference: concept to reality in crop improvement". *Planta* 239 (3): 543–564. DOI:10.1007/s00425-013-2019-5
- Saxena, S., Jonsson, Z. O. and Dutta, A. (2003) Small RNAs with imperfect match to endogenous mRNA repress translation. *J. Biol. Chem.*, 278, 44312–44319.
- Scacheri, P. C., Rozenblatt-Rosen, O., Caplen, N. J., Wolfsberg, T. G., Umayam, L., Lee, J. C., Hughes, C. M., Shanmugam, K. S., Bhattacharjee, A., Meyerson, M. and Collins, F. S. (2004) Short interfering RNAs can induce unexpected and divergent changes in the levels of untargeted proteins in mammalian cells. *Proc. Natl Acad. Sci. USA*, 101, 1892–1897.
- Slanchev, K., Stebler, J., Goudarzi, M., Cojocar, V., Weidinger, G., Raz, E. (2009) Control of Dead end localization and activity--implications for the function of the protein in antagonizing miRNA function. *Mech Dev.* 2009 Mar-Apr;126(3-4):270-7. doi: 10.1016/j.mod.2008.10.006.
- Su, BF. 2012. Reproductive Confinement of Common Carp, *Cyprinus carpio*, and Channel Catfish, *Ictalurus punctatus*, via Transgenic Sterilization. Dissertation. *Fisheries and Allied Aquacultures. Auburn University.* 2012-12-05.
- Su, BF., Shang, M., Grewe, P.M., Patil, J.G., Peatman, E., Perera, D.A., Cheng, Q., Li, C., Weng, C-C., Li, P., Liu, ZJ., Dunham, R.A. (2015) Suppression and restoration of primordial germ cell marker gene expression in channel catfish, *Ictalurus punctatus*, using knockdown constructs regulated by copper transport protein gene promoters: Potential for reversible transgenic sterilization. *Theriogenology*. Volume 84, Issue 9, December 2015, Pages 1499–1512. doi:10.1016/j.theriogenology.2015.07.037
- Thresher, Ron., Grewe, P., Patil, J. G., Whyard, S., Templeton, Ch.M., Chaimongol, A., Hardy, C., Hinds, L. A., and Dunham, R. A., 2009. Development of Repressible Sterility to Prevent the Establishment of Feral Populations of Exotic and Genetically Modified Animals. *Aquaculture* 290, no. 1–2: 104-09.

- Thresher, Ron., Hinds,L.A., Hardy,C., Whyard, S., Vignarajan, S., Grewe, P., and Patil, J.,2005. Repressible Sterility of Animals. USA.
- Tucker C.S., Hargreaves J.A. (2004) Biology and Culture of Channel Catfish.
- Weidinger, G., Stebler, J., Slanchev, K., Dumstrei, K., Wise, C., Lovell- Badge, R., et al. (2003) Dead end, a Novel Vertebrate Germ Plasm Component, Is Required for Zebrafish Primordial Germ Cell Migration and Survival. *Current Biology*, Volume 13, Issue 16, 1429 – 1434. DOI: 10.1016/S0960-9822(03)00537-2
- Wong, T-T., Collodi, P. (2013) Inducible Sterilization of Zebrafish by Disruption of Primordial Germ Cell Migration. *PLoS ONE* 8(6): e68455. doi:10.1371/journal.pone.0068455
- Xu, H., Lim, M., Dwarakanath, M., Hong, Y. 2014. Vasa Identifies Germ Cells and Critical Stages of Oogenesis in the Asian Seabass. *Int J Biol Sci* 2014; 10(2):225-235. doi:10.7150/ijbs.6797.
- Yoon, C., Kawakami, K., Hopkins. N. (1997) Zebrafish vasa homologue RNA is localized to the cleavage planes of 2- and 4-cell-stage embryos and is expressed in the primordial germ cells. *Development*. 1997 124: 3157-3165;