

**An Approach for the Industrial Designer to Incorporate Virtual DIY Communities as a
Resource in Product Design**

by

W. Travis Lontz

A thesis submitted to the Graduate faculty of
Auburn University
In partial fulfillment
For the Degree of
Master of Industrial Design

Auburn, Alabama
August 6, 2011

Keywords: DIY, Technical Resource, Design Assistance,

Copyright 2011 by William Travis Lontz

Approved by

Tsailu Liu, Chair, Associate Professor of Industrial Design
Clark Lundell, Professor and Department Head of Industrial Design
Shea Tillman, Associate Professor of Industrial Design

Abstract

Product development by industrial designers is an expensive, time consuming, risky process. It requires a significant dedication of resources and capital. However, the DIY community consistently produces innovative, unique solutions with minimal investment. These individual development efforts are often assisted by online communities arranged around common interests. The practical knowledge and experience available in online forums, blogs, newsgroups and build logs could be an important resource to designers if they know where to look and are willing to become part of these communities. This research provides an example of a portion of the design process conducted with assistance from virtual DIY communities.

Acknowledgements

This thesis would not have been possible without the support of many people. I first must recognize the encouragement and patience of my wife in support of this venture. Not only did she adapt to my time away from the family, but she also has remained upbeat and helpful in the process. I would also like to thank Professor Tsailu Liu, without whom I would not have learned or experienced many things that made this program worthwhile. To these and the rest of the wonderful faculty at Auburn, I give my thanks.

Table of Contents

Abstract	ii
Acknowledgements	iii
Table of Contents.....	iv
List of Tables.....	vi
List of Figures	vii
Definition of Key Terms and Acronyms.....	ix
Introduction.....	1
DIY	4
DIY online.....	9
The Virtual Community	10
Blogs and Build Logs.....	13
Instructables	17
Forums	18
Project.....	24
Project Background.....	24
ICE Bicycles	26
Electric Bicycles.....	29
Bicycle Trailers.....	33
Attachment methods.....	36
One vs. Two wheel trailer	40

Project Implementation	42
Project Outcome	81
Observations and Recommendations.....	98
Types of Assistance.....	98
Encouragement	98
Links to Other Informational Sites.....	98
Links to Products	99
Context Specific Searches.....	100
Non-COTS (Commercial-Off-the-Shelf) Parts.....	100
Inspiration to Innovate	101
Caution.....	103
Technical knowledge and nomenclature.....	104
“How to” information	104
Disadvantages and Limitations.....	105
Lack of control	105
Spam	106
Information discovery limitations.....	106
Site reliability	106
Recommendations.....	107
References.....	112

List of Tables

Table 1: Comparison of one and two wheeled trailers	41
Table 2: User needs	82
Table 3: Metrics and target specifications	83
Table 4: Addressed needs	96

List of Figures

Figure 1: Operations map of a product.....	2
Figure 2: Concept order of operations	3
Figure 3: Graph of responses to need vs. effort.....	7
Figure 4: "Completed" e-bike build	8
Figure 6: Home page of Maushammer's build log.....	14
Figure 7: DIY R2D2 Droid.....	15
Figure 8: Instructables.com home page	17
Figure 9: Topic listing on Product Design Forums website.....	21
Figure 11: Internal combustion engine kit for bicycle.....	26
Figure 12: Internal combustion engine kit components	27
Figure 13: Grease and electrical tape on bicycle engine	28
Figure 14: Fuel leak on bicycle engine kit	29
Figure 15: Neodymics cyclemotor kit.....	30
Figure 16: Cyclemotor kit installed.....	31
Figure 17: The \$12,000 Optibike 850R	32
Figure 18: Hauling heavy loads with a bicycle trailer.....	34
Figure 19: Antique pusher trailer design	34
Figure 20: Moving people with bicycle trailers	34
Figure 21: DIY pusher trailer from scooter parts	35
Figure 22: Ridekick electric assist trailer ("Ridekick™", 2010).....	36

Figure 23: 6.5 hp pusher trailer attaching to seat post.....	37
Figure 24: Diagram of forces from a seat post trailer.....	38
Figure 25: Fork and hinge from BOB trailer	39
Figure 26: BOB Yak single wheel trailer	40
Figure 27: Initial sketches to explore geometry	85
Figure 28: Additional geometry explorations	86
Figure 29: Form and mass sketching	87
Figure 30: Exploring placement of batteries	87
Figure 31: Form and feature concepts.....	88
Figure 32: Initial CAD models of trailer with bike	89
Figure 33: CAD model exploring component arrangement	90
Figure 34: Final form of trailer project.....	91
Figure 35: Trailer with multiple styles of bikes	92
Figure 36: Trailer concept in use	92
Figure 37: Feature details of final concept.....	93
Figure 38: wireless controller concept in use	94
Figure 39: Wireless throttle and display	94
Figure 40: Trailer being charged	95
Figure 41: Streamlined Art Deco locomotive	97
Figure 42: Product logo.....	97
Figure 43: YouTube video of inspiring concept.....	103
Figure 44: Recommended process for designing amongst virtual communities.....	110

Definition of Key Terms and Acronyms

BMS – battery management system – Electronics designed to protect the cells in the battery from potentially damaging too high or too low voltage

Bump – add a post to the end of a thread to make it appear higher in the chronological list on the topic in a forum

COTS – commercial off the shelf

DIY – do it yourself – a belief or practice that prompts an individual to solve problems using their own skills and resources instead of purchasing a solution

DIYer – a practitioner of the DIY ethic

ICE – internal combustion engine

LVC – low battery cutoff – Electronic switch that will turn off the batteries when their voltage dips too low

Mouseover – a graphic change in a website when the computer mouse icon passes over the active portion of the page

Reads – the number of unique users that have read a post on a forum

Thread – a recorded forum conversation consisting of a post and replies

Introduction

Industrial designers are constantly faced with challenges that arrive with each new project they begin. As professionals, industrial designers must work with the latest developments in electronics, mechanisms, and technology. Frequently the designs they are tasked with creating must include systems that are new or unfamiliar to them. The designers must gain a working knowledge of the components, arrangement, interactions, and limitations of the components that they must incorporate into the new design. The more understanding designers have about how the technical features of a product work, the more efficient they will be with their time and resources.

For example, in a recent university studio, a design student tasked with producing concepts for a new line of generators spent time looking at the human interaction with a currently available product. The student documented the steps needed to start and operate the unit and compiled a map of positions the user needed to access. The seven steps for starting the unit included rotary switches, linear switches, and plungers to pump and rotate. This instruction list had potential for simplification. This problem discovery was performed and documented well, providing an area for product improvement.

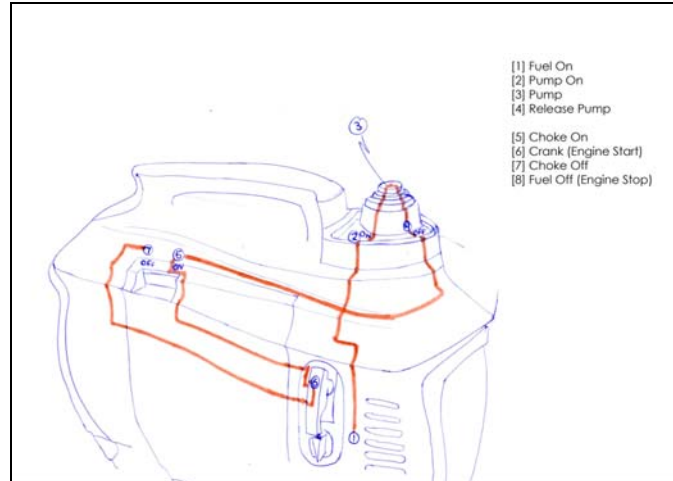

Figure 1: Operations map of a product

The concept the designer developed significantly simplified and improved the type of interaction a user would have with the product. Instead of moving to different positions on the product and operating multiple kinds of switches and levers, the steps were reduced to an indexed rotation of a single handle. This design was well considered and documented.

However, when the client's engineer reviewed the design, it was discarded because it would have required electronic, mechanical, and cord routing complexities that were not mechanically possible to implement. The designer's lack of knowledge of the technical function of the parts for which he was designing caused him to spend time on designs that were impossible. A better working knowledge of the function of the choke, fuel valve, and recoil mechanisms would have made him better prepared to answer their concerns or would have directed him to work on concepts with potential future.

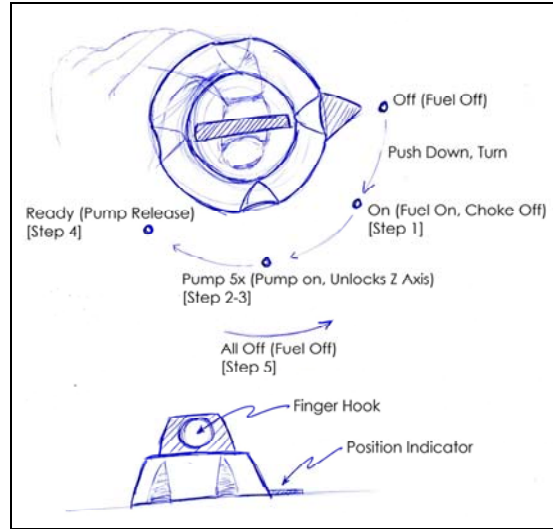

Figure 2: Concept order of operations

Where can industrial designers find this technical information about the latest developments and innovations around which they are designing products? Increasingly, bookshelf-filled libraries are not useful in gaining this type of information because the pace of technological and product development does not allow for timely publication of books or even journal articles about the pertinent information. Frequently, books and technical journals are too technical and academic for the designer to quickly understand and absorb practical information useful to their design. Often, proprietary design information about some products is not shared by manufacturers, and can only be gained by expensive reverse engineering of existing products. More frequently, technical components come from offshore vendors, and may not have sufficient or accurate usage, function, or performance documentation.

Industrial design jobs exist in many different types of businesses, ranging from huge multinational corporations to contract design houses and the independent freelance proprietor. Some designers have an in-house staff of engineers that can offer the support of their technical

knowledge of the unfamiliar components. Occasionally, the inventor of a new technology is available to assist designers with questions they have about the function of specified parts. Contacting manufacturers and distributors of new products is frequently a great resource to insure the correct usage of technical components.

However, not all industrial designers have access to these resources, or the information does not exist through typical channels. This lack of a knowledge resource costs designers money and time. Money and hours can be wasted purchasing and dismantling competing products. Time can be spent prototyping and testing concepts that do not ever work.

This research study is intended to raise awareness of another potential source of technical information that designers can use to improve the integration of technical components into their designs: online communities of do-it-yourself (DIY) enthusiasts. Online communities are internet-based gatherings for discussion of a topic of shared interest. DIYers use these groups to brag about what they have built, complain, encourage, assist, and learn about others' creations. Topics for these DIY forums range from motorcycles to photography to cooking or butterfly collecting. This researcher will document an example interface with these communities and propose an approach for designers to join, participate in, and benefit from these communities. Of particular interest to this research is the online forum.

DIY

Do It Yourself, or DIY, is a widely used term that refers to the attitude or action of an individual to create, repair, improve, or assemble desired outcomes by a combination of effort and skill instead of simple purchase. The modern marketplace has embraced the ideals of the DIYer and supports them with shopping opportunities, project instructions, tools, and venues

for cooperation and communication. This support exists not only in the physical world, but virtually as well by means of the internet.

DIY is not unique to the internet age. However, there is some question as to when the term was first used, as it can be applied to describe very different types of communities. In fact, this is part of the usefulness to the designer of the DIY ethic, in that it is actually a sub-culture of multiple different genres. DIYers can be found participating in diverse areas from media to construction, and birthing to house moving. The diversity of application of the DIY ethic is a benefit to industrial designers because the support available can be found for the diverse projects designers are tasked to work on.

Musicians and writers created a movement of self publication and distribution in the 1940s and 50s that continued with punk culture and anti-consumerism in the 70s and 80s (Spencer, 2005). Teal describes the fan magazines (zines) of the 1930's that were self-published communications of individual interests and ideals. Later punk music zines continued to use the rougher, hand-crafted look to "to create a recognizable graphic design aesthetic" (Teal, 2006). This media is currently described as DIY, and clearly is, but the originators were interested in the ideal, not the label.

Much of the DIY literature today refers to home improvement. In the post-war era of WWI and again after WWII, a lack of resources and skilled labor created a need for individuals to meet their own needs. It became necessary, and then even fashionable, to develop the skills necessary to mend and create. Media helped to promote the desirable nature of DIY home improvement with books and magazines.

Atkinson (2006), while attempting to define DIY, divided the topic into several areas. He described a difference between a “need” based DIY and a “leisure” focus. An additional clarification broke down DIY by division into “the making of objects” versus “the maintenance of the home.” Additional attempts at classification analyze the differences between “art”, “craft,” and “design” (Atkinson, 2006). While these clarifications are necessary if creating a strict definition of DIY, it is the “skills and resourcefulness” of the adherents, regardless of their focus, that is pertinent to this research.

All consumers eventually face a need or problem that requires a product or tool that they do not have. The solution to meet this need will involve some associated effort. If the need is not too great, the problem can be ignored or endured. If the need is great, then it can be worth the effort and expense to purchase a device that solves the problem. If such a product does not exist, there can be reactions ranging from active to passive. The individuals can wait for someone else to solve the problem or solve the problem themselves. DIYers may or may not have higher skill levels than those without the DIY ethic. So even if the effort to solve their own problems is not lower for them than others, they are willing to do the extra work.

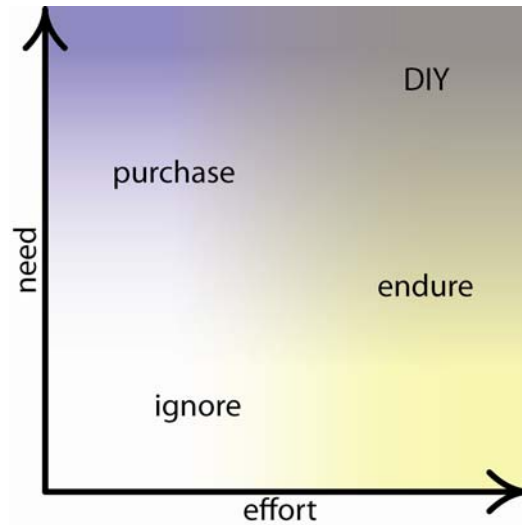

Figure 3: Graph of responses to need vs. effort

Unlike professional designers who must design a finished product with thousands of diverse users, a DIYer has only one customer to please. Issues such as ergonomics, aesthetics, and safety are entirely up to the single user, and therefore the level of finish is normally low. A forum member posted a picture of his newly completed bike (Figure 4). The resulting device is not considered a prototype, but a “completed build.” The user is satisfied with the finish and quality of the project, and therefore it is complete. However, it may be true that all of the projects on the forums are simply working prototypes since the users are constantly tweaking and improving them.



Figure 4: "Completed" e-bike build

<http://visforvoltage.org/forum/9686-i-finished-my-ebike-project>

There is a broad range of problem-solving ability and level of finish produced by DIY users. Some are trying to solve a problem with the least effort and difficulty possible. The products resulting from this type of effort are typically barely functional and may not last very long. Other DIY builders create for the love of the medium and demonstrate an incredible level of skill in their creations.



Figure 5: Contrast between highly finished veneer bicycle camping trailer and cheap quick modification

Regardless of the quality, all of these users have decided that the obstacles encountered in creating new things are worth the effort. There are countless decisions to make when creating something without instruction. The builder must consider which tools are required, how many fasteners, where to source the components, and if the parts are strong enough. Even with the most basic designs, information on how and why these creations were attempted can be valuable to others attempting something similar, and certainly to designers interested in the “why” and not just the “how.”

The practical information available from the builders of these projects is of significant value to designers. Anyone can comment and complain about the lack of products to fill a need, and this type of information is easily available with user reviews and opinions posted on almost every retail website. Frequently, even the most impractical users can propose ideas of how to solve problems. Anyone can look at a situation and form an opinion about how to improve it. But it is the DIY individual that will try things and actually attempt to solve difficulties with real solutions. The trial and error documentation of these efforts, both success and failure, from a group of these people enables the designer to avoid similar mistakes, adopt successful concepts, and skip forward past the testing and evaluation of some elements of their designs.

DIY online

DIY forums are unique amongst online groups in that they not only discuss and give opinions on topics, but the members are actively engaged in making something new. As an example, the Google groups directory lists 696 English-speaking groups organized around recreational cycling ("Google groups," 2011). Most of these groups are used to arrange group

rides, discuss training, or give product purchase advice. This is an active set of online communities, but only a few of these groups or a small subset of their members actively creates their own bicycles and therefore can be categorized as DIY. It is this drive to create, when combined with encouragement and inspiration from others of the same interests, that creates a DIY online community.

The Lawn Mower forum, (<http://www.lawnmowerforum.com/#lawn-mower-forums>) has 2435 members as of 3/22/11. Most topics contain conversations about lawn care, purchasing, and general mower-related discussions. However, there is a topic reserved specifically for “build it yourself” (<http://www.lawnmowerforum.com/build-yourself/>) where members post and discuss problems they have overcome by designing and building or modifying their own equipment. The initiative, creativity, practical knowledge, and willingness to experiment of these particular members are the vital elements needed to assist designers.

The Virtual Community

Humans are social by design. It is the interaction with other people that makes people who they are (Christakis & Fowler, 2009). Historically, face-to-face interaction amongst people as they go about their lives and the geographic location where this occurs is the basis for community. Increasingly though, interaction with others involves the use of computers, and this electronic communication removes the requirement of co-location. Communities can exist entirely online in internet-based groups that have been given the label virtual communities.

Harold Rheingold is credited for coining this phrase as a title for a 1993 book documenting his exploration of an online gathering called “the WELL” starting in 1985.

"When you think of a title for a book, you are forced to think of something short and evocative, like, well, 'The Virtual Community,' even though a more accurate title might be: 'People who use computers to communicate, form friendships that sometimes form the basis of communities, but you have to be careful to not mistake the tool for the task and think that just writing words on a screen is the same thing as real community.'" – Howard Rheingold

WELL stands for “Whole Earth ‘Lectronic Link” and has been in constant operation for 25 years at <http://www.well.com/>. Rheingold joined this community of intelligent early adopters who became members of a group to share experiences, discuss philosophy, and encourage exploration of this new medium of exchange.

Early in his description of his interaction with the group, he relates a story about a medical question about his young daughter that he and his wife took different approaches to answer. At 11:30 pm, his wife called the pediatrician, and he posted the question on a parenting conference on the Well. He had gotten an answer and provided the medical attention needed before the pediatrician even called back. What impressed him most:

“...wasn't just the speed with which we obtained precisely the information we needed to know, right when we needed to know it. It was also the immense inner sense of security that comes with discovering that real people--most of them parents, some of them nurses, doctors, and midwives--are available, around the clock, if you need them. There is a magic protective circle around the atmosphere of this particular conference. We're talking about our sons and daughters in this forum, not about our computers or our opinions about philosophy, and many of us feel that this tacit understanding sanctifies the virtual space.

The atmosphere of the Parenting conference--the attitudes people exhibit to each other in the tone of what they say in public--is part of what continues to attract me. People who never have much to contribute in political debate, technical argument, or intellectual gamesmanship turn out to have a lot to say about raising children. People you knew as fierce, even nasty, intellectual opponents in other contexts give you emotional support on a deeper level, parent to parent, within the boundaries of Parenting, a small but warmly human corner of cyberspace" (Rheingold, 1993).

This personal interaction available in multitudes of online meeting sites draws millions to spend their time conversing amongst the community members. With Rheingold, the first attraction was this parenting topic, but he goes on to relate many such stories of interaction with other people on other topics using the web as a communication tool. With the DIY community, the draw is the other members with similar interests that post about their creations.

There are currently many different methods of communication on the web. DIY users employ many different tools to interact with others. Blogs, Instructables, YouTube, Flickr[®], IM and Facebook all provide ways to share their interests. However, DIY forums are the unique form of recorded conversation that this researcher believes is the best venue and creates the clearest unfettered plug into the DIY community for technical research and assistance.

Blogs and Build Logs

A weblog, or blog, is an online site that consists of dated entries. People began to use this form of communication in the late 1990's, and there were only 23 weblogs being maintained at the beginning of 1999. The term weblog, pronounced "wee blog," was shortened to blog by Cameron Barrett. Barrett maintained an early list of sites of this type. New software released in mid-1999 enabled less technical users to publish their own blogs, and an explosion of new sites resulted. These sites are basically public diaries or journals in which people record their thoughts on any topic they wish, and frequently provide links to other sites (Blood, 2000).

DIYers use blogs to document things they are interested in and publish information about what they have created. There is a unique form of blog called a build log that documents the steps used to build a project. For instance, John Maushammer, at http://www.maushammer.com/systems/watch/Build_Log/Build_Log.html, has a build log in which he documents his progress building watches.

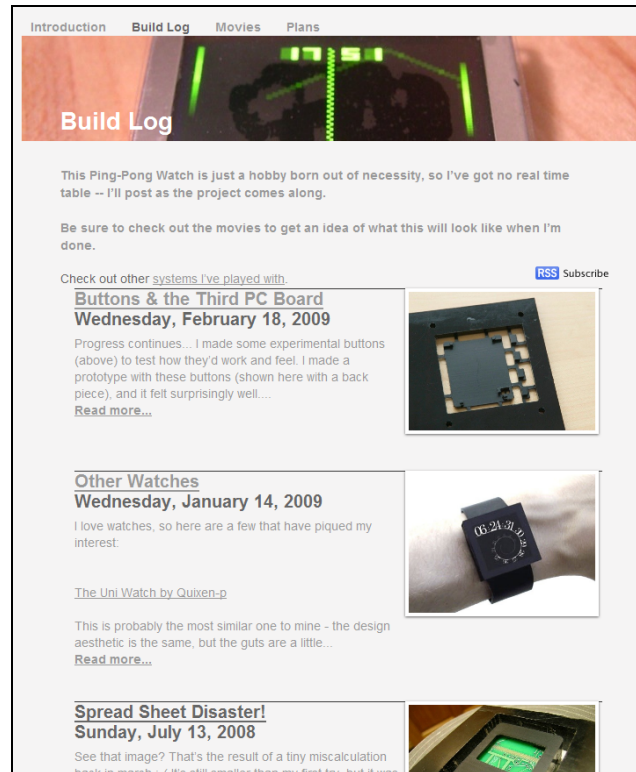

Figure 6: Home page of Maushammer's build log

Anyone in the world can read this incremental documentation as he posts his decisions, designs, mistakes, and corrections. This type of information would be invaluable to a designer tasked with creating something similar. However, at this particular site no one can leave comments or ask clarifying questions except through email on a one-to-one basis. This information then is not available for anyone else to learn.

One interesting item to note is that, during research, a site called BuildLog.net was discovered. This is a site set up as a specialized forum to allow users to post descriptions of their attempts to build a personal CNC laser. The name of this site does not fit with the categorizations in this research. This site is a forum (described beginning p.18) unlike most build logs, which are blogs. A characteristic of DIY users is their propensity, or even need, to

defy convention and labeling. It is not surprising that a DIYer has chosen a name that does not fit a particular set of nomenclature rules.

At a build log called “Victor’s R2D2 Building Diary,” a software engineer named Victor Franco “documents my (mis)adventures in attempting to build my own R2D2” (Franco, 2011). This site is a detailed recording of his progress from 2005 to present of building a working model of an R2D2 droid from the movie *Star Wars*.



Figure 7: DIY R2D2 Droid

Franco’s build log presents details of his decision making, craftsmanship, and purchasing. There is room for comments after each post, but there are few. In his build log, he describes his discovery of other R2 builders and subsequent invitation to a Yahoo group. This group of 10000 was founded in 1999 with the purpose of providing a meeting place for others interested in building the same thing. It seems that most of Franco’s contacts and interaction involves this group.

On some blogs, readers can leave comments, and the author and others can respond. The comment tool provides for some limited interaction, but was not designed to record conversations. The main content is driven by a single person, and this limits the community interface. This researcher believes that though these build logs are a good source of information, they are not the best resource to reach into the DIY community since they are not designed for community interaction.

Instructables

“Instructables is a web-based documentation platform where passionate people share what they do and how they do it, and learn from and collaborate with others” (“About instructables,” 2011).

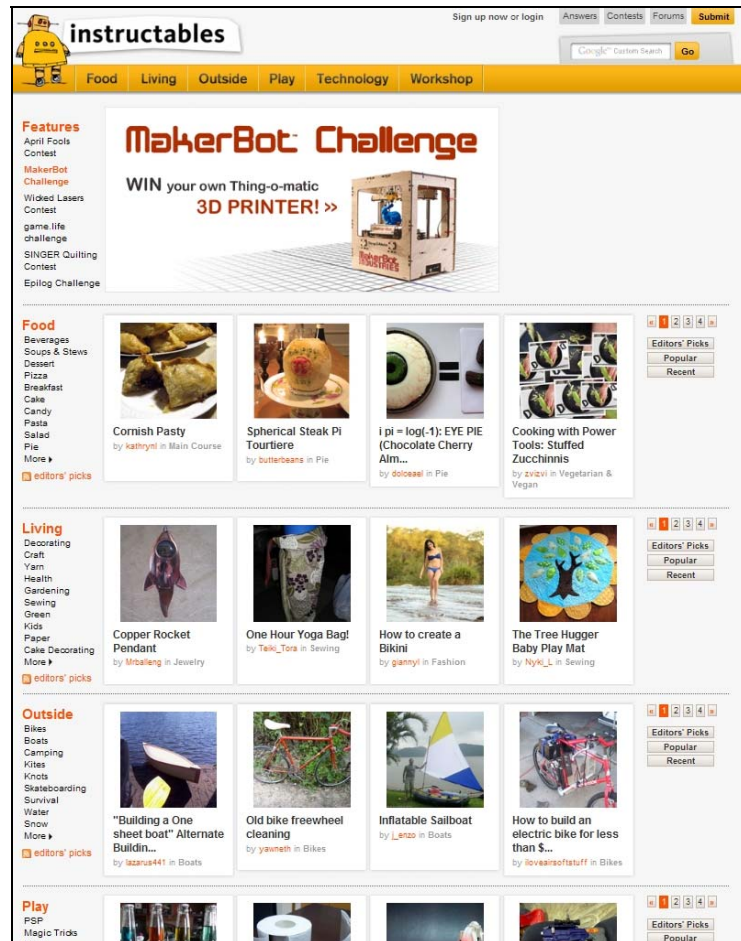

Figure 8: Instructables.com home page

This site is a well organized way for the DIY community to share information. It has a categorical listing of project instructions that users have created to show “how to.” The large

number of views per month, 4.3 Million, shows the popularity of this approach ("Instructables statistics," 2011). However, for technical research, the site has some limitations.

A typical instructional post will have 8 to 20 pages of labeled pictures along with step-by-step instructions on where to source materials, what order to proceed in building, and sometimes drawings of parts. The drawback for the designer is that they are specific instructions on how to build one particular thing that has already been created. Designers can see what has been done. Each step of the instructions has a place for comments, and these are searchable. So a designer faced with a specific technical challenge can search for that information whether it is in the comments or the original post. However, designers will more than likely not want to reproduce the item exactly. There is not usually enough text for the author to explain much of the decision making process.

The site is so huge, and topics are so varied, that there is not a conversational, community feel. The content available is extremely diverse, but since someone who registered to post about food can comment on the metalworking topics, the interaction on the comments is not always specific enough to be helpful. On this site, the comments are not the focus; the original post is. Users cannot start their own topic without posting their own Instructable.

Forums

Another form of communication for DIYers is the internet forum. Also known as message boards, these sites began as electronic bulletin boards or newsgroups in the early days of communication between computers. This form of "recorded conversation" may be one of

the best ways for designers to join with and benefit from the DIY community due to how it connects specific people with a wealth of specific, searchable experiences recorded over time.

Walt Howe, co-author of one of the earliest books on the internet, describes the beginning of internet forums in his “A Brief History of the Internet”:

“The Unix to Unix Copy Protocol (UUCP) was invented in 1978 at Bell Labs. Usenet was started in 1979 based on UUCP. Newsgroups, which are discussion groups focusing on a topic, followed, providing a means of exchanging information throughout the world. While Usenet is not considered as part of the Internet, since it does not share the use of TCP/IP, it linked Unix systems around the world, and many Internet sites took advantage of the availability of newsgroups. It was a significant part of the community building that took place on the networks” (Howe, 2010).

These Usenets, also known as newsgroups, were the method by which early computer users could communicate with each other. Usenets consisted of a location to which the user, on a slow dial up connection over the phone lines, could connect to download a text-based list of conversations organized by topic. Responses would be composed offline and uploaded at the next connection. This was a cumbersome task requiring a high level of technical knowledge, but it was the only way to send messages to remote users before the standardization of email as a means of electronic communication.

Modern day forums are available on the World Wide Web through a browser window. Forum hosts use one of several different kinds of software to make these boards available, but the interfaces are similar, and their purpose is the same. They create a place for like-minded people to interact. In these forums, this takes the form of a recorded text-based conversation. Rheingold (1993) lists the topics of conversation in the parenting conference on the WELL,

and describes them this way: “Each of these entries is the name of a conversation that includes scores or hundreds of individual contributions spread over a period of days or years, like a long, topical cocktail party you can rewind back to the beginning to find out who said what before you got there.”

WiseGeek describes an internet forum as “a discussion area on a website. Website members can post discussions and read and respond to posts by other forum members. An Internet forum can be focused on nearly any subject and a sense of an online community, or virtual community, tends to develop among forum members” (Cyprus, 2011). It is the “read and respond” focus that makes the forum a place where these communities can develop.

The great value in these types of communities is the wealth of historical data that is kept by use of the threading format. Years of responses are recorded and presented in an understandable format. It is possible to get to know personalities of the members while reading posts to various topics, and get a sense of knowing the member while reviewing these comments left for other members and projects undertaken over time.

Yahoo groups and Google groups also have a historical recording of responses in their formats, similar to internet forums. However, investigation into Yahoo groups shows that they mainly interface through email, and responses to postings frequently include headers and indented copies of previous emails. Formatting issues and image removal from spam filters leave empty references in the text. This visual and comprehension noise makes conversations difficult to follow.

Google groups are set up in a forum arrangement, with formatted replies that are easy to follow. Groups by nature have a narrowly defined focus. For example, the aforementioned

R2 builders group only focuses on building R2 units. In contrast, forums are set up with a broader interest topic and allow for postings in several categories related to the topic.

The screenshot shows the Product Design Forums website interface. At the top, there are logos for 'PRODUCT DESIGN FORUMS', 'solidThinking', and '8.5 better faster easier'. Below the navigation bar, the 'Forums' section is active. The main content area is divided into three sections: 'Main Forums', 'Show Your Work', and 'Skills & Know Hows'. Each section contains a table of forum topics with columns for 'Forum', 'Stats', and 'Last Post Info'.

Main Forums		
Forum	Stats	Last Post Info
Design Challenge #6 Design for the Disadvantaged and WIN a solidThinking 8.5 inspired commercial license	7 Topics 18 Replies	Yesterday, 03:55 PM In: My Entry By: Bustifurr
Design Discussions talk about industrial design, events, books, articles, trends, innovation, materials, etc... Design in China Competitions & Events	1,830 Topics 7,118 Replies	Today, 02:27 AM In: 2011Franzaward Break The Bo... By: franzaward
Random Musings unwind, get to know one another, share interesting stuff, etc...	417 Topics 3,470 Replies	06 May 2011 - 05:19 PM In: Introductions! By: CKNOBoy

Show Your Work		
Forum	Stats	Last Post Info
Finished Projects show your finished work	1,038 Topics 8,996 Replies	Yesterday, 11:39 PM In: Laptop Bag By: RICANJO
Projects in Progress show your work in progress	679 Topics 4,582 Replies	Yesterday, 08:40 PM In: Bicycle Parking Design By: JONGHDESIGN
Portfolios show your portfolio for review	686 Topics 3,181 Replies	Yesterday, 09:58 AM In: Tips for creating a portfolio By: jackwebb87
Sketches & Renderings show your random sketches, illustrations and 2D/3D (CAD) renderings Sketch Challenges	1,446 Topics 15,342 Replies	08 May 2011 - 10:54 PM In: Pontiac And Other Vehicles By: advancedboy
Archives Design Challenges	226 Topics 1,516 Replies	01 September 2008 - 05:11 AM In: Voting Has Ended: View The ... By: ----

Skills & Know Hows		
Forum	Stats	Last Post Info
Materials, prototyping and manufacturing	442 Topics 2,084 Replies	Yesterday, 02:27 AM In: Can Any Body From The Uk He... By: montecarlos
2D skills and equipment general discussions about sketching / illustrating / rendering / hardware / software Tutorials	707 Topics 3,533 Replies	Yesterday, 11:39 PM In: Lighting Fundamental Resour... By: I3nch

Figure 9: Topic listing on Product Design Forums website

Most forums have a search function that enables the user to enter specific key words and receive a list of threads that mention the topic. This is invaluable in discovering threads covering subjects of interest, as well as finding which members are interested in pertinent topics. Some forums require registration to unlock advanced search functions.

The conversational nature of these forum threads contributes to the community feel. Members feeling comfortable and welcomed into the environment are more likely to share. Care is taken by most members to carefully word replies to avoid offense.

Industrial designers joining a community like this have several advantages. They have the opportunity to read past conversations between members as they share their ideas, methods, mistakes, and successes. The descriptions of the DIYers' build processes and the decisions made as they progress are valuable information about what might work for the designers' project. The database of conversations can be searched for key words associated with key components of their design concepts. Conversations containing technical information may be easier to read than academic textbooks containing the same information. DIYers will provide countless examples of applied theory and technology that are more interesting than fabricated examples from instructional text.

Another advantage to these forums is the contact with "prosumers" and "superusers." These individuals are the type that "treats the world as a place for creation, not consumption." Tapscott and Williams (2006) give the example of Lego prosumer communities. The release of Lego Mindstorms robotic toys gave rise to user groups that "within three weeks of its release had reverse engineered and reprogrammed the sensors, motors and controller devices." These modifications were uploaded, described, and shared amongst the DIYers. The user groups

and forums where this information was shared were initially seen as a threat by Lego, but a shift in policy permitted the company to embrace the interested customers. Currently, the company “benefits hugely from the work of this volunteer business web.”

Though the Mindstorms example is an extreme case, this kind of resource is available in countless other product areas. DIYers like these disassemble, hack, improve, and share information that could be beneficial to designers involved with their forum communities.

This research includes an example of how a designer can better fuel his or her creative process and refine his or her ideas from the forum format of these DIY virtual communities. A portion of an electric bicycle design project was completed with assistance from a DIY forum. The record of this experience will serve as encouragement for other industrial designers, as well as provide an example of the types of assistance that are available.

Project

As a vehicle for research into the resources available on virtual DIY communities, a highly technical design project was required. This project needed to involve technology that the researcher was not familiar with in order to ensure that the interactions in the DIY community would be authentic, as well as truly beneficial to the project. Due to the time constraints on this research, the project could not be a complete design effort. Since the focus of the research is the collection of technical data, only a section of the design process is detailed. Limited information and early design decisions are noted in order to establish a background for the main effort to produce a working prototype for testing. Because of these considerations, the project chosen was to design a bicycle power assist accessory.

Project Background

Pollution, traffic, limited parking, insurance, gas prices... These are reasons not to drive a car. Most readers of this research have firsthand experience of sitting in traffic. Constantly elevating levels of road congestion make travel by car increasingly inefficient. The engine on an SUV running to the corner store to pick up some milk is hauling more than 4000 pounds of unnecessary metal, burning expensive gas, and is not traveling significantly faster than a bicycle if you account for traffic lights and finding parking.

According to the Federal Highway Administration, over half of vehicle trips in the US are 10 miles or fewer (U.S. D.O.T., 2008).

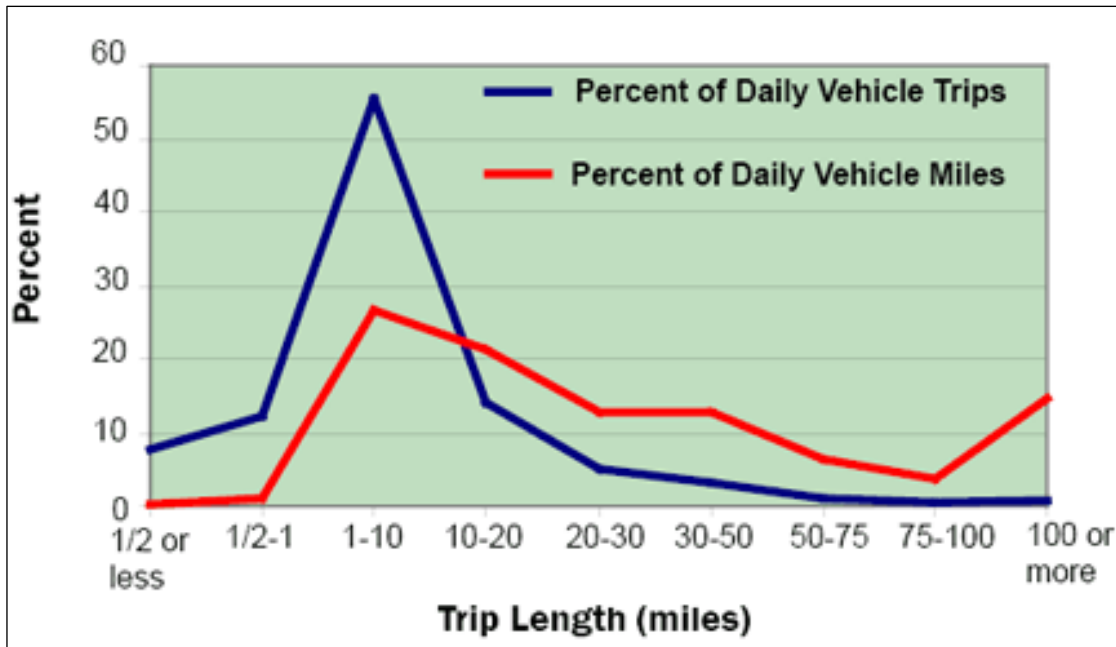

Figure 10: Graph of trip length (U.S. D.O.T., 2008)

These distances are within reach of riding a bike, one of the most efficient forms of human transportation (Wilson, 1973). However, riding a bike also has its difficulties. Few roads have bike lanes (Auburn, AL, is considered bike friendly, with 44 miles of dedicated bike lanes or paths, but this is only a tiny percentage of its total roads) so the speed of the bike relative to the cars on a road can cause safety concerns. There is also the problem of exertion. On hilly terrain, riding up hills can be exhausting. In hot or humid climates, the rider will sweat easily. If the trip includes shopping, the rider usually does not have a place to carry cargo.

A way to make bicycle riding more appealing, safer in traffic, and less taxing on hills would be add a motor to assist the rider in moving the bike forward. There are quite a few concepts for bicycle assistance on the market. There are internal combustion engines (ICE)

that can drive one wheel of the bicycle available as add-on kits. There are electric add-on kits, as well as factory-made electric bikes.

Federal law does not regulate bicycles as motor vehicles if they have electric motors under 750 Watts (1 HP) with a maximum speed of 20 mph without rider assistance (15 USC Sec. 2085). State laws vary widely and are the only regulation of ICE bicycles.

ICE Bicycles

ICE-equipped bikes are powerful, fast, and relatively inexpensive. They are also messy, finicky, complex, heavy, and loud, and they carry flammable fuel. The researcher happened upon a group of people gathered on a sidewalk, speaking to the owner of a bike. He had installed a motor-assist kit into his older mountain bike frame. This opportunity allowed for some observations to be made.



Figure 11: Internal combustion engine kit for bicycle

The motor sits in the main triangle of the bicycle frame and is secured with U-bolts around the frame. It is a two stroke, single cylinder, 49 cc, 2.2 HP kit that sells for about \$200. The kit has 33 separate parts that must be assembled during kit installation. The owner spoke of how the bike vibrated uncomfortably during use, requiring constant attention to bolts coming loose. However, the bike was fast, up to 45 mph, and therefore the owner believed it was worth the effort.



Figure 12: Internal combustion engine kit components

Closer observation of the motor showed that the first impression of a nicely packaged system had some significant issues. There was an oil leak fouling the frame, multiple wires and cables attached to the frame with electrical tape, and exposed bolt ends in the path of the user's ankles while pedaling.



Figure 13: Grease and electrical tape on bicycle engine

The crowd asked for a demonstration of the bike, and the owner complied. He mounted the bike, pedaled some distance away to turn around, and began pedaling back. Releasing a clutch bump started the motor, and he began to move back toward us under power. As he paused near the crowd to show the system running, one member of the group noted that there was a fluid leak. The owner looked down and recognized that the fuel line had slipped off of the motor, and was draining gasoline onto the muffler and pooling on the ground. The owner casually squeezed the line back onto the motor, while stating that this happened every once in a while. He then motored off down the sidewalk.



Figure 14: Fuel leak on bicycle engine kit

From a product design point of view, this researcher believes that this product is too complex for all but highly skilled users, time intensive to maintain and use, polluting, and loud. It also appears to be dangerous not only to the rider but to bystanders as well. If the muffler had been hot, the gasoline could have ignited and caused injury.

Electric Bicycles

In contrast to gasoline power, electric motors are quiet, reliable and light, but the required batteries are expensive. Confusing installation of add-on kits and unfamiliar purchase options limit appeal. A potential buyer of an electric bicycle assist kit will be faced with many decisions. Front or rear, direct or geared, wattage, voltage, battery chemistry, battery location... the list of decisions is extensive, and each requires some level of knowledge of the system. The vast majority of these kits are manufactured overseas, so documentation quality

and product reliability are questionable. Once the kit is received, the installation of the system requires technical knowledge about how a bike is assembled. Many web sites have information to help with these choices, but this type of technical conversion will only appeal to a small set of technology-savvy buyers.

One company has attempted to remove the technical knowledge component of an electrical assist kit by designing a system to replace the front wheel with a complete kit. All components for the retrofit are contained on the system, so there is no bicycle modification necessary. This constraint required the company to satisfy significant technical hurdles. The company website claims the kit installs easily and provides assistance that does not permanently alter the bike or change riding dynamics ("Cyclemotor installation," 2007). However, the appearance of the system is disconcerting.

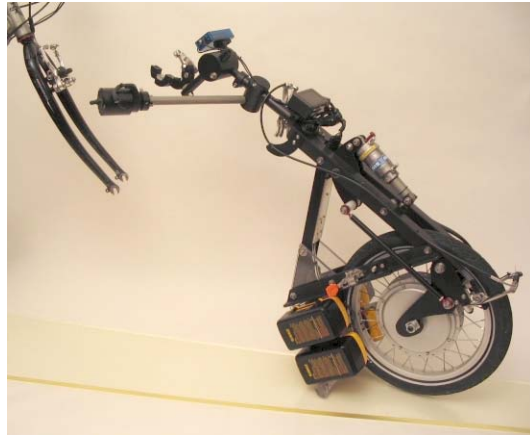

Figure 15: Neodymics cyclemotor kit



Figure 16: Cyclemotor kit installed

As an option to the electric add-on kit, buyers may opt to purchase a factory-built electric bicycle. These bicycles range in price from \$300 to \$12,000, with a bike of good quality components costing around \$1,500. The vast array of manufacturers offering electric bikes makes the decision difficult, as the buyer must consider not only the specifications for the electrical system but the bicycle as well. For example, Amazon offers 482 products for purchase when searching for “electric bicycle” in their sports and outdoors category.



Figure 17: The \$12,000 Optibike 850R
("Optibike 850R", 2010)

For this project, the focus is a product for a user with little technical knowledge and few tools and who may be intimidated by an add-on kit that requires more permanent bicycle modification for installation. The intended product will be an accessory that can be installed on most any bike and does not significantly alter the bike itself. This format decouples the electric power decision from the bicycle purchase and includes current bicycle owners in the target market.

In addition to the ease of use, the design will feature ease of installation, increased cargo capacity, and will not significantly affect the operation of a bicycle. The product will detach from the bicycle when not needed. For example, a mountain bike rider may wish to have assistance on hills when riding to and from work. This same rider would not want the added weight of the batteries and motor when taking the bike onto trails on the weekend. A

road bike owner may wish to have additional power and cargo capacity to run to the corner store but on a different occasion want to use just the bike for exercise.

The result of this background research, decision making, and project requirements led the researcher to choose to design an electric pusher trailer. This accessory will attach to the rear of a bicycle and include the motor, batteries, and controller. The integration of components into a single product will eliminate most of the modifications required by add-on kits. The simplicity of attachment will allow the product to be removed with minimal effort.

Bicycle Trailers

Bicycle trailers have been used for years to haul cargo, equipment, and children. The trailer can have either one or two wheels, each design having advantages and disadvantages. The dynamics of trailers are well understood, and many methods have been implemented to attach the trailers to bicycles. They can haul heavy loads on level ground, and the dynamics of slowing down these trailers is very similar to the feel of having a trailer push a rider.



Figure 18: Hauling heavy loads with a bicycle trailer



Figure 19: Antique pusher trailer design



Figure 20: Moving people with bicycle trailers

Concepts for pusher trailers have been around for more than 100 years. The web is well populated with ideas, projects, and plans from DIY users. Many are gas powered, as small gas engines are inexpensive.



Figure 21: DIY pusher trailer from scooter parts

However, there is only one powered trailer product on the retail market in the U.S. This electric motor driven design first appeared on the market in 2010. The company is still ramping up and has yet to deliver products. Dubbed the Ridekick™, this \$550 two-wheeled device is easily attached low on the rear of the bicycle ("Ridekick™," 2010).



Figure 22: Ridekick electric assist trailer ("Ridekick™," 2010)

Attachment methods

A trailer hitch on a bicycle must allow for relative movement on at least two axes. A vertical axis hinge (yaw) is necessary to allow the bicycle to rotate around its rear wheel in a turn without sweeping the trailer along with the rotation. A horizontal hinge axis perpendicular to the forward direction of the bicycle (pitch) will allow the trailer wheel to move up and down in relation to the ground. This allows the wheel to stay on the ground as the bike changes pitch while going over bumps and dips. The third degree of freedom, a horizontal axis parallel to the forward direction (roll) is needed with a two-wheeled trailer, as the bike will lean to the side in a turn while the trailer will not. With a one-wheeled trailer, this

third axis must be removed. The trailer will lean along with the bicycle when turning but must be supported from falling to the side.



Figure 23: 6.5 hp pusher trailer attaching to seat post

There are three common methods with which trailers are hitched to the bicycle: seat post, left chainstay, and rear axle. All of these methods must transfer forces from the trailer to the point where the bike is in contact with the road.

With seat post attachment, a connecting member is bent to clear the rear wheel of the bicycle and clamped to the vertical post that supports the seat. The hinge is normally close to the connection point. This geometry makes for a simple connection, but it is not the best method when it comes to bicycle stability. When looking at the forces involved for a trailer being pulled by a bike, transferring all of the force through a position high above the ground causes the bike to want to lean. This will mean that the rider will have to correct for this force each time the trailer is not directly behind the bike ("Bicycle trailer guide," n.d.).

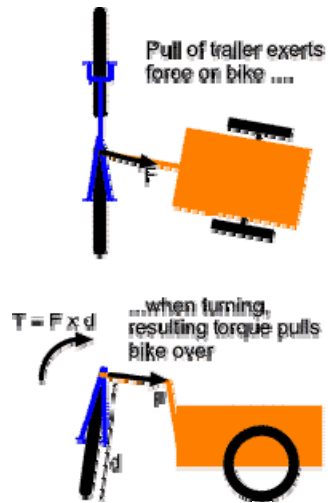

Figure 24: Diagram of forces from a seat post trailer

The force diagram in Figure 24 considers pulling a load in a trailer, so the opposite forces will be evident when the trailer is pushing. “Ultimately, every force acting on the bike is expressed at the points of contact between the tires and the road. The farther the trailer hitch is from those points, the greater its effect on the handling of the bike. A seat post-hitched trailer will have more leverage to push the bike over during a corner compared to an axle-mounted hitch. The ideal hitch would connect to the bicycle exactly at the point where the tire meets the road. Such a hitch would be impossible to build, however, so the axle-mounted hitch is the next best thing” (Davis, 2007).

Two-wheel trailers frequently have a connection point near the rear axle of the bicycle, connected to the chain stay or the seat stay, opposite the chain, normally on the left side of the bike. The connecting member must be bent to allow for the sweep of the rear wheel if the bike turns sharply to the right. This bent tube does not affect the width of a large trailer, but will protrude farther and therefore increase the width of narrow trailers, as shown in the bottom

image of Figure 22 above. This type of hitch is therefore not appropriate for a narrow single-wheel trailer.

Many single wheel trailers attach to both sides of the rear axle. A frame loops around the rear of the tire and provides an attachment point for the trailer. Typically, the hinge is located close to the rear wheel, supported top and bottom by the frame. This type of connection provides for a quick release that requires little modification to the bike.



Figure 25: Fork and hinge from BOB trailer



Figure 26: BOB Yak single wheel trailer

One vs. Two wheel trailer

The researcher has experience with two-wheel bike trailers, having used one to haul cargo as well as a different format to transport children. The size of the trailer, both for storage as well as while underway, is a constant frustration. There is difficulty inherent in pulling an object that is significantly wider than the bike. This is compounded when the rider cannot see the trailer in use and must “get a feel” for how large the trailer is to avoid objects. For this application, a two-wheel trailer’s cargo capacity is unnecessary, and its advantage of stationary stability can be designed into a single-wheel trailer with a center stand. The narrow profile of the single-wheel trailer is its main advantage. This is beneficial for storage and while in use. A single-wheel trailer follows along in the same track as the bike that is towing it. This means that the rider does not have to be constantly aware of increased width, as with a two wheel trailer. There is less risk of grinding on a curb or hitting pedestrians, cars, or other obstacles.

	Manufacturers	Advantages	Disadvantages
One-wheel Bike Trailers	B.O.B. KoolStop	narrow (great for trail riding) leans with bike (= less likely to roll over when rounding corners at high speed)	low cargo capacity (both in weight and volume) must be loaded and unloaded symmetrically to keep trailer from tipping over some have reported they can wobble when loaded heavily
Two-wheel Bike Trailers	BicycleR Evolution Burley CycleTote Wike Bikes At Work	much greater potential cargo capacity stable when loading and unloading	usually wider can roll over when rounding a turn at speed

Table 1: Comparison of one and two wheeled trailers
("Bicycle trailer guide," n.d.)

The research into potential function solutions for the trailer geometry and power source has guided the researcher to choose to develop a single-wheel, electric-powered, low-mounted bicycle trailer. The complexity of the design, as well as the need to prove functionality, requires the researcher to create a functional prototype of the system. The acquisition of technical knowledge needed for the creation of this system will provide an example of the assistance available from the online DIY community.

Project Implementation

The background information that was collected before the start of this project guided the project to a certain stage of development. This information was summarized to show that there were informed choices when selecting the approach to the product, but extensive design research was not possible within the schedule. The objective was to observe and analyze the portion of the process as it relates to technical knowledge. This proposed product is complex enough that a functional prototype has to be built and tested in order to evaluate the potential viability of the form chosen. The development of this functional prototype is the basis for the research into the technical knowledge available on the DIY forums.

Atypical of most design thesis projects, the physical project in this case is not a result of the thesis findings. It is instead a way to both demonstrate and discover information about the main theme. The project is conducted as the research. In order to document the assistance received from the DIY community, the following table, a transcription of the forum thread used in the research for this project, is included. Interspersed in the forum thread is a chronological set of notes taken in a journal format while the project was underway. To distinguish between forum posts and journal entries, the forum posts have a gray background. Forum entries also have numbers to allow for cross-reference. All of these entries are informal and unedited, both in the journal notes and forum conversation. Grammar and spelling mistakes have not been corrected. The right column is a commentary including observations, explanations, and comments.

In order to remove identifiable information, names, dates, and links have been changed. The researcher's username has been replaced by "Researcher," and all posts under

this name are by him. This threaded conversation took place over a three month period in the spring of 2011.

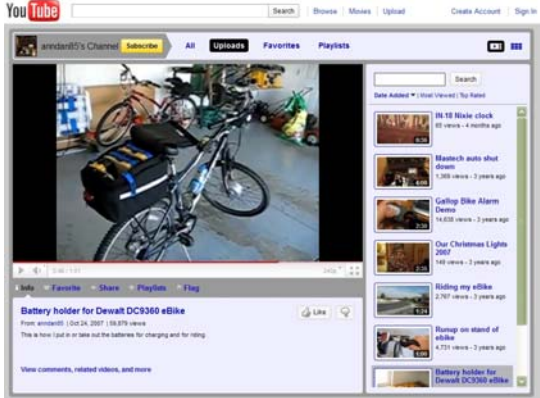
Journal transcript	Commentary
<p data-bbox="279 457 386 491">1/27/11</p> <p data-bbox="279 554 902 1167">Early on in consideration of this project, the need for batteries became apparent. There are many different choices for battery chemistry, and the decision requires tradeoffs. One of the inspirations for the project is a DIY user's post on YouTube from 1997. The individual comments that he had been "skulking around the Internet and 'borrowing' ideas off a lot of people." He assembled an electric bike with used components and DeWalt cordless tool batteries (anndan85, 2007).</p>  <p data-bbox="279 1703 902 1854">The researcher had the fortune of getting some of these expensive batteries donated for the project and knew that use of them would</p>	<p data-bbox="1040 1797 1390 1881">The donor wished to remain anonymous.</p>

require new technical knowledge planned to be gained through interactions on the DIY forums.



This approach to the research is a bit out of order from the typical design process. The researcher had a firm idea of what he wanted to build first, and then went about finding parts for it. It is interesting to note that this is similar to the DIY mindset. As demonstrated by anndan85, DIY'ers will collect little tidbits of input for a long time and then reach a critical decision point where they kick off the project. The methodical approach to research used by designers is slower and more comprehensive.

I have posted on several forums at this point. I have not written down what I posted on [a forum] and now I can't find the post. I don't know if anyone has commented.

Since I had received the batteries, I posted on [a forum] yesterday:

The names of the forums and users have been removed to insure that this research contains no identifiable information.

Posting on many forums at the beginning of the research is necessary. See the Recommendations section p. 107.

<p>DeWalt 36V CAD Posted: Thu -----, 2011 9:44 am by Researcher I have been searching the forum, but cannot find any mention of CAD files for the DeWalt 36V batteries or interface. Has anyone taken the time to model the batteries, and would be willing to share? I scored 6 of the batteries cheap, and not being an electronics genius, am not willing to risk disassembly to build my own packs. I bought some of Kf----'s interface boards and plan to wire up 3 or 4 of them in parallel. Having the CAD files for the battery and socket would make this build go a lot faster. Thanks</p> <hr/> <p>Re: DeWalt 36V Posted: Thu-----, 2011 10:18 am by ne----- hopefully someone will post what your looking for but until then i'd recommend u PM Li----- -- as he has experience w/ dewalt pack setup</p>	<p>There were no additional replies to this post as of the writing of this paper. The posting has moved down many pages in the topic, and is therefore less likely to have anyone read it. The post may need a “bump” to get any additional reads. See the Recommendations section p. 107.</p> <p>The researcher created his own CAD models of the needed components.</p>
<p>No information yet, but directed to a source that may be helpful. The “PM” recommendation is a personal message. Basically a localized email that the user will get next time he logs in to the forum.</p>	<p>Personal messages are a way to directly contact the users on a forum. This is an effective way to contact potential knowledgeable members for assistance. This topic is further discussed in the Recommendations section p. 107.</p>

	<i>Forum thread transcript</i>	<i>Commentary</i>
1.	<p><i>Electric trailer research</i> <small>□</small>Posted: Thu --- --, 2011 4:52 pm by Researcher I'm finally getting started documenting my</p>	<p>The researcher was uncertain</p>

<p>electric pusher trailer build. I'm doing this for a thesis project for a design degree. I want to promote the vast amount of information and expertise that are on DIY forums like this one.</p> <p>Since this is for a design project, I am not just building something that I will be able to use, but want a product with production potential that anyone, with experience or not, can use. I need to design a product for a user with less technical knowledge and tools than you guys here. I am thinking that it needs to be like an accessory that did not significantly change the bike itself. Something that will come off of the bike when you want to ride it yourself. For instance, on a mountain bike you don't necessarily want a 10lb motor unsprung in the front wheel when you are out popping roots. On a road bike, you may want the assistance for a commute to work, but then remove it for some exercise or training on the weekends.</p> <p>The result of this narrowing of focus leads me to an electric pusher trailer. Pusher trailers have been around for a long time as a concept, and there are an amazing number, variety, and quality of builds on this site. However, there are few electric trailers on the market. They have never really caught on, and I think this is due to a focus on the die-hard cyclist, and not the general public that own an underutilized bike.</p> <p>As far as geometry, I have seen some that attach to the seat post, but this may not be the best geometry. The closer the connection of the trailer is to the contact patch of the rear wheel, the less disturbing the mass is to deal with. There are a couple of trailers I've seen that attached to the lugs on both sides, but they were long cargo trailers. This would make</p>	<p>if this information would affect the willingness of forum members to comment. The desire to have this project become a retail product may have caused people to be less willing to participate. However, this potential “for profit” statement did not cause the project to fail.</p> <p>An “un-sprung” weight is one that must travel up and down over bumps along with the wheel since it is located before the suspension. Additional un-sprung weight reduces the effectiveness of suspension components.</p> <p>The researcher wanted to summarize the initial direction he wanted the design to follow. Most forum readers will start at the beginning of a thread that they are unfamiliar with. It was important to</p>
--	--

	<p>city/campus/parking more difficult. I am leaning toward an extrawheel trailer. I am going to combine the lug mounted style with a hub motor to take advantage of the dynamics, and short length, and simple implementation.</p>	<p>put this summary at the beginning.</p>
<p>2.</p>	<p><i>Re: Electric trailer research</i> <input type="checkbox"/>Posted: Thu --- --, 2011 8:06 pm by Ra----- Researcher, good luck with your trailer build. I think my total number of pusher trailers is about 10, some two wheel and some one wheel. All the one wheel trailers were connected to the bike with a BOB hitch, whether the trailer was an actual BOB trailer or not.</p> <p>I found that for pushing my bike, a LWB recumbent, the shorter the trailer the twitchier (is that a word?), it got. Even with the weight held down low, the trailer would make the bike unstable. The best pushers for a bike were either two wheel (i.e. two hub motors) trailers or long trailers such as a regular BOB trailer. I think the two wheel trailers worked good because they weren't affected much by the slight side to side motion created as the bike was pedaled and balanced.</p> <p>I don't use any pusher trailers anymore because I'm so happy with my mid-drive that allows the motor to use the eight gears in the IGH. The mid-drive with the gears has eliminated all problems with hills, at least to 20% grade. I do use my BOB trailer in stock form to carry cargo when needed.</p>	<p>The electric pusher trailer is not a new concept, and some of the inspiration for the concept came from reading DIY forums.</p> <p>A LWB recumbent is a “long wheel base” bike on which you recline in a wide seat.</p> <p>This information was vital to the success of the project. This “twitchiness” did present itself, and the configuration of the trailer had to be adjusted to overcome it.</p> <p>This user would likely never be a potential customer due to his skill level and ability to install custom kits onto his bicycle.</p>
<p>3.</p>	<p><i>Re: Electric trailer research</i> <input type="checkbox"/>Posted: Thu --- --, 2011 11:12 pm by Researcher Ra-----, Thank you for that input. I'll be looking out for that "twitchiness". The intention of my</p>	

first build is to test the dynamics of the trailer. I expect to have to go through several rounds of re-building. I wonder if a collapsible trailer is possible. Extend to a long wheelbase while in use to smooth it out, and then collapse or fold to make fitting into a bike rack and locking up easier.

I have a pile of parts that I have scored from various sources. I found a 400w hub motor and controller:



I also just got a big pile of DeWalt

This concept of an extendable trailer is in response to the direction supplied in the previous post. The concept may not have occurred to the researcher if not for this posting.

Used parts from eBay are a typical place for DIYers to find components. The components shown here were an inexpensive way to start the prototyping process, but none ended up in the final iteration.

Motor Controller

Twist type throttle

batteries:



and for those, I need to solder up some BMS interface boards from Kf-----:



Shown here are the components for the interface boards purchased from a forum member. Members creating kits to sell is not uncommon on forums. See comments on the 2/3/11 journal entry for a description of these PCB's.

Additional components were purchased from DigiKey.

2/3/11

I received all of the parts to start the interface boards for the DeWalt batteries. I took

Through reading postings from DIYers that have used the

the time to write up a blog post on how I came to decide on these batteries. I have to keep up with the documentation so it does not get away from me.

I need to start my own build log to start gaining comments and suggestions. I'm a little unsure now how to proceed with the distribution of this battery decision information to the forums. The information on the blog is general for anyone to read, not specific to any forum. On the forums, especially if I reference their threads, I think I need to be more specific. Do I post the same thing on all of the forums? I will promote my blog, and have a counter that I just installed to gauge the # of visitors.



DeWalt batteries for their projects, the researcher learned that the batteries have a circuit board, called a BMS, which protects the cells from overcharging and over discharging. When in use in power tools, internal tool circuitry interfaces with the BMS to regulate power delivery. Without this interface circuitry, the batteries are either susceptible to damage, or will turn themselves off. The researcher discovered a forum member that had designed and was selling his own interface boards for using the batteries outside of their intended purpose.

The researcher, along with forum postings, started a blog. As a build log, this blog was intended to document the process of creating the project. It was planned as a central place to post project information. However, the time to write the blog, along with trying to keep up with the forums, proved to be too difficult.

<p>4. <i>Re: Electric trailer research</i> ☐ Posted: Thu --- --, 2011 11:14 pm by Researcher I also scavenged some dead bikes around campus to use for parts:</p>	
---	--



I'll get some images up soon of what I am planning to do with this mess of parts in my garage.

A text heavy thread is less interesting and attractive for people to read. The more pictures available of what you are building, the more responses you will get. The researcher was surprised at the amount of details that members will discover and respond to from posted pictures.

5. Re: Electric trailer research
 □Posted: **Thu --- --, 2011 11:49 pm**
 by **Lo-----**

Researcher wrote: Pusher trailers have been around for a long time...`

Just something fun for your files then...
 Bernardi, 1893:



☺
 Lo-----

6. Re: Electric trailer research
 □Posted: **Sun --- --, 2011 10:48 am**
 by **Bc-----**

Here's my E-BOB.....crystalite front hub laced into a 16" 50-305 Schwalbe Big Apple, EZEE 36V 9.6ah Lithium Ion batt and a 25a controller.....Sweet Ride, coupled with my Catrike Trail

This post contains a considerable amount of jargon. See

		<p>the Recommendations section p. 107.</p>
<p>7.</p>	<p><i>Re: Electric trailer research</i> <input type="checkbox"/> Posted: Thu --- --, 2011 9:00 am by researcher Thanks for the pictures guys. The 1893 picture looks like a steam powered friction drive. Betcha that was loud. <i>Bc----- wrote: Here's my E-BOB..</i></p> <p>Bc-----, that looks like a lot of fun! Was the e-BOB purchased, or built by you? The yoke on the front of the trailer seems to be built for a larger wheel, does this affect handling with the pivot further back? only the throttle and wiring are on the bike, right, the rest of the components are on the trailer?</p>	<p>The researcher was wrong. This turned out to be an early internal combustion engine.</p> <p>There was no reply to the questions in this post.</p>

<p>2/10/11</p> <p>I finally got kf-----'s boards soldered up and tried to hook up the motor. I used one battery just to see if the motor would spin. I was using "anderson powerpole" connectors on the wiring. I crimped a set onto the end of the wires for the controller and from the battery. I plugged the system up, and nothing happened. By</p>	<p>These connectors were recommended by members of several different forums.</p>
--	--

wiggling all of the components, I found that the connectors were not making contact. I wondered if I had installed them properly, and I found this on a forum:

<http://endless-sphere.com/forums/viewtopic.php?f=16&t=2767>

I realized that I had the parts in wrong, so after I corrected this, the indicator lights on the throttle lit up. The controller has a buzzer on it that I did not expect. It screeched that the voltage was low. This is because the 36V DeWalt is not 36, but 33V. This means that it is lower than the 38-40V that the controller is expecting from the original SLA batteries. I realized that the controller, without the inline inductor, should have tripped the internal BMS on the board. I looked at the board and realized that I had wired it wrong, and was using the unprotected side. This risked damaging the batteries by blowing a fuse.

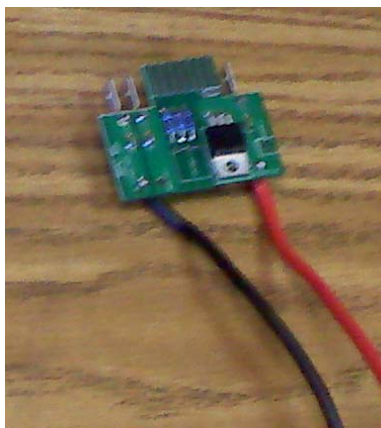

This link is to a forum posting where the member has created a video to show how to properly install these connectors. The Anderson website also has instructions, but they are a multi-page highly technical document. Having a video demonstration was easier to understand.

This low voltage issue took considerable time and effort to overcome. SLA's are "sealed lead acid" batteries.

The forum member that supplied the boards also provided a ferrite coil to act as an inductor to reduce voltage spikes. Forum postings by this member described the assembly and wiring needed, but the researcher made a mistake during assembly. The DeWalt battery has two outputs, one straight from the cells, and one that is regulated by the BMS. The unregulated output has a single use fuse to prevent destroying the cells, a potentially dangerous situation. This fuse is not replaceable.

I corrected the incorrect wiring and tried again. The controller did just what was expected; the inrush current from the capacitors in the controller tripped the BMS in the battery, dropping the available voltage to 0. I realized that the forum members were right, and I needed to add an inline inductor to limit the current. An inductor reduces peaks in voltage spikes. I put the inductor in line (after checking the forums to see which wire to use) and it worked just as they said it would.

I used one of the DeWalt batteries to test a different project, and came back the next morning to find that the BMS was warm. This means it was discharging energy. The charger indicated that the battery was bad, so I took it apart, since I had read that if one cell was too low the charger would not function. If that cell could be brought back to higher voltage, you could rescue the whole pack. I found that there were twice as many cells as expected. I'll have to see if anyone else has noted this by posting the information on the forum. The craze on the batteries is over, and I'll have to see if anyone still does anything with these batteries. I tested each cell for voltage. Some were full, and others were completely empty. This means that the BMS went bad. Thing to note: information on the

The inductor limited the current, which then stayed under the BMS limit, providing useful regulated power.

Other forum posts documented the disassembly of these batteries to harvest the cells to use in custom battery packs. These postings are several years old, and it seems that DeWalt has changed the cells in the battery. This is useful information to post back to the forums even though the threads are old. Old threads are ones that have not had posts within months or years. The threads are still active, and will accept new posts, but no one has

<p>forums can be dated. Be sure to get updated information if possible. This means posting on old threads, but may save some aggravation.</p> <p>I spent time last night thinking of alternatives to the single vertical axis joint btw the trailer and bike, as well as how to make an extendable trailer.</p>	<p>had new information worth sharing.</p> <p>The first post in response to the researcher's trailer proposal on the forum [Appendix paragraph 2, p. 4547] cautions that a short single wheel trailer would have problems tracking smoothly. This prompted ideation to solve this potential problem.</p>
---	---

<p>8. <i>Re: Electric trailer research</i> <small>Posted: Thu --- --, 2011 9:37 am</small> by researcher I soldered up one of the boards from Kf-----, and went to test out all of the parts I got from ebay. The components are off of an old ebike called a "callisto" There is a 36V controller (brushed) and throttle. I can't find any information about it, and all of the parts are potted. It has a 31V LVC, which is turning out to cause problems. The motor is a Heinzman. From what I have heard, it is a really reliable brushed, geared motor.</p> <p>I completed one board first because I wanted to see if it worked, and wanted to test out the controller and motor which I have never seen work. I hooked everything up, and the wheel actually turned!</p>	<p>The purchase of the used parts, while saving money, did increase the risk. The parts were proven to work, but eventually were not used.</p>
---	--



It was really quiet, and hit about 200rpm unloaded. I think this is about 15 mph according to this chart: <http://endless-sphere.com/forums/viewtopic.php?f=28&t=16114>

The controller is turning out to be an issue because it is expecting SLA voltages. A 36V SLA battery bank will read well above 36 when fully charged, correct? The fully charged DeWalt batteries are only reading 33V at full charge, and when I spin up the motor, they drop to 31 pretty quickly. Therefore the charge meter on the throttle reads low and the controller cuts off the supply after a few seconds. As far as I know the DeWalt batteries can go as low as 24V without damage, so I have a ton of unused potential. I went ahead and finished the rest of the boards, and tried two batteries in parallel. It improved the time the wheel would spin, but still under a minute.

So, do I get another controller, or find some SLA batteries? What do I look for in a brushed motor controller? is reliability an issue? How do I hook up my throttle with the 6 or so wires?

Forums are filled with information that has been formatted and shared for everyone's use. This chart made it easy to convert RPM to mph.

The low voltage issue was the most difficult to track down and solve.

Batteries running in parallel can supply more amperage than a single battery. Batteries running in series supply more voltage.

No immediate answers to these questions.

2/17/11

Spent a couple of hours in the past two

<p>days welding up a trial trailer. I rode it home today and it performed well. I'm happy with my welds, and happy that the trailer is mostly unnoticeable. I ran it initially with full air pressure, and it bounced a lot and I could feel it through the bars. It made the washers jingle. I let a lot of air out, and it popped over road bumps, but did not bounce more than once per hit. The low pressure tire had a dampening effect on the bouncing. Backing the bike is impossible. The short wheel base jackknifes the trailer instantly. If the trailer is oriented 90 deg to the bike, or further, the hinge portion can rotate to the ground. This makes the wheel hard to put back behind. There is nothing to limit its motion. Is limitation needed? I thought a double hinge may work as it did on the 4 wheel trailer at work, to take out possible vibration/oscillation. One, I didn't really see any, and two then I don't think it will push well.</p> <p>So, how much weight is needed to keep the wheel on the ground? How much weight is too much? Can I add damping some how? The batteries will be seeing huge accelerations. They will have to be well restrained. I'm falling behind with the pictures and documentation and posting.</p>	<p>The researcher had just learned to weld to support this project.</p> <p>This bouncing is an issue that has continued to plague this design. Reducing the air pressure helps with this, but potentially can lead to rim damage on the trailer wheel.</p> <p>These issues are evidence that this working prototype was absolutely necessary. Solving the problems that were found will ensure that the final product concept was proven in the real world, and not just an attractive form.</p> <p>The trailer bounced less with more weight on it.</p> <p>The blog only contains a few posts. Past this point in the research, the blog was no longer updated. The time needed to consider the wording and format the pages was not worth the time. There were no comments on the few posts there, and it was not</p>
---	---

	drawing enough visitors to be useful.
--	---------------------------------------

<p>9.</p>	<p><i>Re: Electric trailer research</i> <input type="checkbox"/>Posted: Mon --- --, 2011 7:50 am by Researcher I still haven't figured out the LVC issue with the controller. I did finally get 4 batteries in parallel, and it will run longer, but with any real torque on the wheel, the controller will trip. Any ideas on how to change the cutoff, or are there brushed controllers out there without one?</p>	
<p>10.</p>	<p><i>Re: Electric trailer research</i> <input type="checkbox"/>Posted: Mon --- --, 2011 9:32 am by Ji----- Sounds like you have two choices for the controller: (1) just buy a new one (36 v brushed motor controllers are fairly cheap) and hope it doesn't have the same low voltage cutoff problem; or (2) dig out all the potting and post some pictures; brushed controllers are not very complicated and should just be a matter of changing some resistance somewhere.</p>	<p>These two recommendations turned out to be a waste of time. Searches for a 36V controller without an LVC produced nothing, and the researcher was not willing to risk a purchase on the “hope it doesn’t have the same problem.” The potting on the existing controller could not be removed.</p>
<p>11.</p>	<p><i>Controller problems?</i> <input type="checkbox"/>Posted: Mon --- --, 2011 9:37 am by Researcher I ordered a brushless motor and controller from Cycle9. They came in last week.</p>	<p>These components were ordered from an electric bicycle store, cycle9, to provide a basis for comparison with the brushed motor. Forum members had noted differences in reliability, noise, and</p>



It came with a 25A infineon controller that has a direct connection to a Cycle Analyst. I thought that the cycle analyst could change the LVC of the controller, but even if I set the CA to a 25V cutoff, when I load the motor, the controller will cut out. It is only pulling 4 amps, and I can't see the voltage sag because it happens too quick. The BMS in the DeWalts are not tripping, so the only thing I can think of is the LVC on the controller.

How have you guys with the DeWalts dealt with this? the 33V max charge on the batteries is killing me.

power between the two formats.

The cycle analyst (CA) is a device created by an electric bike shop in Canada that has active DIY forum members. They saw the need for a device that supplied feedback on energy usage and created a product that has become the standard for DIY electric bike builds. The CA was purchased along with the brushless motor and controller.

2/21/11

What to post next? No action for days. I welded a lot and tested out the trailer, but don't have many pics to show. Will have to fix the broken weld to get some pics.

What to do about the cycle analyst. I've got the two. Only one will work with LVC. I need to call cycle9 and ask about this.

When tightening a bolt to connect the trailer to the bike, the weld nut broke loose from the plate it was welded to.

The original cycle analyst sent from cycle9 would not work with the brushed motor controller. It turns out that the expected LVC control did not work as expected.

<p>Posted a specific question about controllers on the forum:</p> <p>Within 1.5 hrs, someone posted twice (15 min apart) with two possible solutions.</p>	<p>[forum post 12]</p> <p>[forum post 13, 14]</p>
---	---

<p>12</p>	<p><i>Re: Electric trailer research</i> <input type="checkbox"/> Posted: Mon --- --, 2011 10:03 am by Researcher I quick probe with the dremel tells me that removing the potting is not going to be possible. It is about an inch thick of metal-hard epoxy.</p> <p>I don't know anything about controllers. If I Google "36V brushed controller", I get some Chinese options (http://www.virtualvillage.com/36v-500w-brush-motor-controller-electric-bike-scooter-004616-153.html?utm_source=googlebase&utm_medium=shcomp), some robotics' options (http://www.pololu.com/catalog/product/760). What am I looking for other than 36V and reasonable amperage? Do most have an LVC, or not?</p>	<p>This is a response to forum post 10.</p>
<p>13</p>	<p><i>Re: Electric trailer research</i> <input type="checkbox"/> Posted: Mon --- --, 2011 11:39 am by Ji----- You can get one from electricrider.com here: http://www.electricrider.com/crystalite/x-ct3625sd.htm</p> <p>It could still have the same problem, though, since it is a 36v controller. Maybe a 24 volt controller would get you around the LVC problem on the 36 V controllers.</p>	<p>This site does not appear on the first 100 hits from a Google search for "36V Controller"</p>

<p>14</p>	<p>Re: Electric trailer research <input type="checkbox"/>Posted: Mon --- --, 2011 11:55 am by Ji----- electricscooterparts.com has a variable voltage controller for 24 to 60 volt operation that does not have any LVC. http://electricscooterparts.com/ hookup/ ... wiring.htm Though it doesn't say specifically if it is for a brushed motor, I assume it is because it only has two wires going to the motor. You could call and ask.</p>	<p>It appears that this user spent more than 15 minutes searching for these parts. This is the same user that proposed the solutions in forum post 10.</p>
<p>15</p>	<p>Re: Electric trailer research <input type="checkbox"/>Posted: Mon --- --, 2011 12:23 pm by Researcher <i>Ji----- wrote: electricscooterparts.com has a variable voltage controller for 24 to 60 volt operation that does not have any LVC.</i> http://electricscooterparts.com/ hookup/ ... wiring.htm <i>Though it doesn't say specifically if it is for a brushed motor, I assume it is because it only has two wires going to the motor. You could call and ask.</i> Excellent. Thank you. It is hard to find some of these sites if you don't know where to look. This never came up on Google.</p>	<p>The italicized text is a “quote” inserted from a previous posting. With a non-linear conversation, this feature is valuable to keep responses associated with previous posts.</p> <p>The site provided by the user does appear on a Google search, for “36V Controller.” However, the product specified is not a 36V controller. The user’s understanding of the product’s potential was missing from the researcher’s experience.</p>
<p>16</p>	<p>Re: Electric trailer research <input type="checkbox"/>Posted: Tue --- --, 2011 9:13 am by Researcher The 24-60V controller seemed like it would solve my LVC problems, so I ordered one. I set it up on the workbench, and hooked up all 4 batteries.</p>	<p>Post number 14 provided a solution to the battery/controller problems.</p>

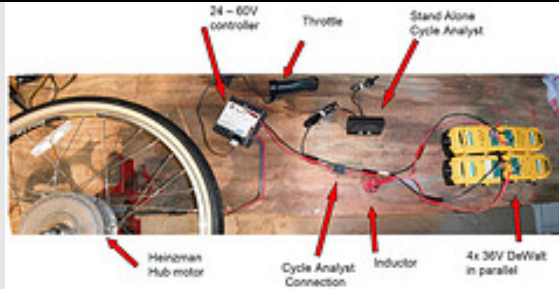

high res link:
<http://www.flickr.com/photos/-----/>

I turned the throttle, and all I got was a blip at about mid twist. I tried again with a slow twist, and got a "groan" or "hum" after about 20 degrees of twist, and then nothing. The Cycle Analyst screen went blank. I let off the throttle, and the CA came back on. It seems like the BMS on the batteries is cutting out. I tried again, just barely twisting past the first hum, and with very careful increases, got the motor to spin all the way up. The active portion of the throttle is only about 20 percent, near the middle of the twist. It hums for about the first half of the active portion, and then quiets. The humming seems to be coming from the hub motor itself, and the inductor that is in between the batteries and controller.

The peak amperage on the CA reads just under 18 amps. This seems to come right at the first power delivery to the motor. I should be able to get 80 amps out of the 4 batteries in parallel, so I don't know why they are cutting out. Any ideas? bigger inductor?

Purchase of the new controller enabled a functional circuit to be completed. The researcher documented the wiring using a camera and labeling the photo with software. Some forums allow images to be uploaded along with posts, but the best way to show pictures is to upload them to a photo sharing site and link to them in the post. A thumbnail shows, and enlarges with a mouseover. However, this feature did not work in this post as seen in post 17 and 18, p. 64.

The described difficulty was frustrating, since the interface PCB and controller had been fixed.

3/3/11

I ordered new controllers after the forum suggestion. I bought the brushed one from the

link the user posted. I returned the included brushless controller from Cycle9 to exchange for the same larger voltage range.

I received the new controllers, with a 24-60V range so there will be no LVC with the 33V batteries. I got the brushed one first and hooked it up. It did not cut off with the controller this time, but it did not spin. It hummed for a blip in the middle of the throttle range, and the BMS on the batteries cut out. Frustration! Now what? I posted online about the difficulties, and the designer of the BMS boards asked for more details. In the meantime, I found that the problem was with my omission of the spacers on the BMS PCB's. The boards were not making good contact with the batteries, and not activating the BMS's. I added these spacers, and was able to get a full amperage range out and the motor spun.

I received the brushless controller a couple of days later, and a bench test proved that I could pull 50 amps from the battery bank.

This puts pressure on the physical design now that the electrical system is working. I need to design a system to mount the batteries and controller onto the trailer. This means some CAD modeling and mechanical design. I spent hours

Experimentation with the circuit enabled discovery of the problem just after the forum members could post, but before the researcher read the response. However, comparison of time stamps between the researcher's post and the reply, (post 16, p.61 and post 17, p.64) reveals that the response came in only 28 minutes. Since the researcher has no control over the quantity, speed, or quality of the postings, the short response time seems impressive.

<p>in the computer lab measuring the batteries, controller, motors and wheels to make CAD models. These are finally in the system, and I can go about designing around these stock components.</p> <p>The main interface complexity is the holder for the batteries. I modeled a socket based off the drill, and sent it to Lau to get a prototype quote. New machine \$67.63 Old machine \$46.55 More expensive than I was hoping. Can I reduce wall thickness? Hollow and add ribs? I'll have to go in to the lab for this. I need 1 for a fit check, and then 3 or 4 more depending on number/severity of changes.</p> <p>Went to lab, reduced volume by ½ by shelling and adding ribs. Submitted for re-quote.</p>	<p>Many members of this forum work with CAD systems, even on their DIY work.</p> <p>The CAD files created for this project probably have some value on the forum. The files should probably be posted and shared. This may be a physical item that could be sold to interested forum members, however, since the pricing mentioned here is much lower than it would cost to make these parts commercially.</p>
--	--

<p>17. <i>Re: Electric trailer research</i> <input type="checkbox"/> Posted: Tue --- --, 2011 9:41 am by Kf----- It sounds like you are getting voltage spikes back into the Dewalts. They shut down when they see any abnormal spikes or current draw and need to be reset. Try winding more wires through that inductor to increase it's value. You can also add another one on the negative wire. The photo is hard to see. I'm not able to verify your wiring setup due to the resolution.</p> <p>Looking forward to the pusher build, I've thought of building something similar to extend my range. I hate the idea of having</p>	<p>This post is from the designer of the BMS interface boards. He has several suggestions and apparently wants more details to be able to spend more time helping find the problem.</p>
---	---

	<p>to drive to the trails just to ride my ebike. A pusher would solve that problem for me, just lock it up once I get there. It would also be a great way to carry extra gear or groceries.</p>	<p>This member wants to ride his ebike off road, contrary to one of the initial expectations for the product.</p>
<p>18.</p>	<p><i>Re: Electric trailer research</i> <input type="checkbox"/> Posted: Tue --- --, 2011 9:55 am by Researcher That photo was supposed to be a link to a high res version. Let's try this: http://www.flickr.com/photos/-----/</p>	<p>Unfamiliarity with the linking feature on the forum meant that the researcher could have missed out on an opportunity for help. Even though the researcher went back to edit the initial post, the mistake stays recorded</p>
<p>19.</p>	<p><i>Re: Electric trailer research</i> <input type="checkbox"/> Posted: Tue --- --, 2011 10:05 am by Researcher I think I figured it out. I had been using the BMS interface boards without the spacer that Kf----- sent along with them. This spacer puts force onto the PCB to make sure it stays against the contacts in the battery. The batteries would work without the spacer, sending a readable voltage. I thought the spacers were just there to prevent vibration loosening during road use, and would not be needed on the bench. However it seems that it is not just vibration that the spacers help with. I must have been pulling voltage out of only one activated BMS, (hence 20 amps) leaving the others to cut off on their own. So, with the spacers, I am not getting any blips, and managed to pull 50 amps! I can twist the throttle without having to nurse it along. Yeah! Now I've got some torque to play with!</p>	<p>These spacer parts came with the PCB's ordered from the forum member. The electrical portion of the build is finally working. The amperage available from the batteries is additive, so having more batteries increases the power available from the motor.</p>

<p>20.</p>	<p><i>Re: Electric trailer research</i> <input type="checkbox"/>Posted: Tue --- --, 2011 10:06 am by Researcher Shoulda done it like Kf----- said in the first place!</p>	
<p>21.</p>	<p><i>Re: Electric trailer research</i> <input type="checkbox"/>Posted: Tue --- --, 2011 10:08 am by Kf----- Yeah, you definitely need the spacers. Without them they don't push up against the contacts. Very important to have.</p>	
	<p>22. <i>Re: Electric trailer research</i> <input type="checkbox"/>Posted: Tue --- --, 2011 10:39 am by Researcher So, in addition to the electronics portion of this build, I have also been working on hardware. I wanted to make a very short trailer, basically just a wheel. There was a caution from Ra----- about short trailers being twitchy. I welded up an ugly prototype so that I could pull it around and feel some of the dynamics.</p> <p>I started with a plate that clamps under the rear quick release on both sides of the bike. I needed an additional screw into the frame to prevent rotation of this plate. There is a weld nut on the plate to receive a bolt that will retain the trailer.</p> 	<p>A working prototype of the trailer was known to be vital to the success of the project. The researcher needed to experience the way that the trailer affected the handling of the bike. In a full-scale design project, several of these trailers would have been created to allow testing by riders with a large range of experience levels.</p> <p>The working prototype also provided real world knowledge of how to maneuver the trailer, on and off of the bicycle. With the hinge in the middle of the trailer,</p>



The trailer itself is a mash up of random donor bike parts. I've got the rear frame off of a cheap suspension bike, a head tube, and a set of forks. I stuck an old rear wheel in it so I would not have to risk my hub motor in case of major failure. It can move up and down by rotating around the bolts on the plate on the bike. It can rotate side to side on the head tube axis (between the green and gray colored parts)



The trailer followed smoothly and was unnoticeable most of the time. It came right behind me through tight turns and up and down curbs. Originally the tire was at full pressure, and I could feel it bouncing over every sidewalk joint. I couldn't feel much through the bike, but there was an annoying jolt I could feel through the handlebars. I stopped and let a significant amount of air out of the tire, such that I could deform it easily with my thumb.

maneuvering the 35 lb system required some effort. Learning this fact means that now the method and mechanisms to attach the trailer to the bike will receive appropriate attention.

In order to have the product be successful, it must not become annoying or disturbing to the rider. Discovering that the unpowered trailer, when tuned properly, was virtually unnoticeable in many riding situations gives support to the concept. The issues encountered will need to be addressed, but without the working prototype, this type of dynamic reaction would not have been encountered.

This really improved the bouncing, such that you could forget it was there. I think the whole setup might weigh 10 pounds.



Boy did I get some strange looks pulling up to a stoplight with this contraption hanging off the back of the bike!

23. *Re: Electric trailer research*

Posted: Tue --- --, 2011 10:51 am

by **Researcher**

I do have a couple of concerns about this setup. One is the fact that the trailer will probably behave differently with a significant load on it. The other is that at high speed when the trailer hit a bump it would fishtail a bit. When it landed it would snap back into place with a pretty good thump. When you watch the videos about the Extrawheel, it is bouncing and twisting the whole time.

http://www.youtube.com/watch?feature=player_detailpage&v=6ijnEr1kn98

It seems that these trailers have been pretty well thrash tested, and come through all right. I need to test how they will react when powered. Is the bouncing going to really diminish their usefulness as a pusher?

I really like the idea of a short trailer because it will store and park much more easily. I hope to be able to get the wheel

The Extrawheel product is a very short unpowered cargo trailer using a large diameter wheel. The product is very durable and has some distinct advantages over loner cargo trailers. This product was part of the inspiration for this project.

The bouncing evident with the Extrawheel trailer has turned out to be an issue with the working prototype. Bumps that do not affect the handling of the bike can cause the trailer wheel to leave the ground

	<p>to fold up next to the rear wheel of the bike so that it can easily be chained. I'm wondering if an extendable frame would be the answer to this. It can be extended for use, and more capacity, and then compressed for parking and storage.</p>	<p>and lose traction. This slows the bike and puts more stress on the motor. The short wheelbase of the trailer makes this bouncing easier. A greater distance from the horizontal hinge to the tire would reduce this action. There may also need to be some sort of suspension and damping system.</p>
--	--	--

<p>3/7/11</p>	<p>More expensive? I am frustrated that access to that machine is only through one person. This means they have no interest/time to spend optimizing or saving money.</p> <p>Should I spend money on this or not? I welded some shelves on Friday that I can bungee the batteries to. Is this sufficient for this prototype? The final will have a different battery form factor that I will not achieve on this project. Do I need this custom part to attach batteries below the shelf?</p>	<p>This journal entry is referencing a quote for the prototype sockets for the batteries. Modifications to the CAD models (journal entry 3/3/11 p. 64) that should have reduced the price of the parts had a slightly opposite effect.</p> <p>These parts would make the working prototype easier to work with, but have no influence on the final design since custom batteries will be necessary. The researcher chose not to have these parts made.</p>
---------------	---	--

<p>24.</p>	<p><i>Re: Electric trailer research</i> <small>Posted: Tue --- --, 2011 11:36 am</small> by Ra----- Nice job on the test trailer. Be sure to make the adjustable frame pretty rigid.</p>	
-------------------	---	--

The old BOB trailer pictured below made a good pusher. This model with the 2 foot long Action Packer tote only got a little squirrely at speeds over 20 MPH or if heavy items were attached on top of the tote. (this was an actual BOB model with the tote, but I never could find any info on it. I cut the original fork off and replaced it with one from an old bike to accommodate a motor)



This forum member modified a COTS trailer to product a device similar to the one under design in this research. His experience with the trailer’s rigidity will improve the resulting design.

By knowing that rigidity affects the high speed dynamics of the trailer, the researcher was sensitive to similar tendencies in the working prototype. Modifications to improve the stiffness (by reducing the size of the wheel and tightening connections) reduced the tendency of the trailer to sway. (see post 25) Knowing to improve rigidity instead of experimentation with other solutions saved the researcher time.

25. Re: Electric trailer research
 □Posted: Mon --- --, 2011 6:58 pm
 by **Researcher**
 I did some welding this weekend, and attached two platforms to the sides of the trailer fork. These will support the batteries, to be bungeed on top for now. Eventually they will hang underneath the platform, and it will be a shelf for carrying whatever load I need. I decided to invert the fork (mount it on the low side) to keep the mass as low as possible.

My first test run was today. I got the controller strapped on, batteries wired, and bolted the contraption onto the bike. I started with the 26" brushed geared Heinzman wheel, and took a couple of

This posting describes the integration of the electrical system and the unpowered trailer prototype.

laps of the driveway. I found that over 10mph, the trailer would wag back and forth pretty severely. I could hear the trailer-bike connection rattling as the side to side motion translated to front to back motion on the connecting bolts. I added a couple of spacers and cinched it down tight on both sides. This removed the front to back play, but the joint would still turn to allow for pitch changes. There was a vast improvement in stability. However I could stand next to the bike and when I grabbed the seat and shook side to side, the wheel itself had play that contributes to the wobble.



I took it out on the road, and there was instant smilage! there is nothing like the feeling of a light pedal speeding you up a hill. The bike was steady at 15mph on flats, and would slow to 12 up hill, but I was pushing 750W if I did not pedal. The motor did not heat up to more than warm. There was more noise than I had hoped. It was like a big model airplane following me around.

The information contained in the member's earlier post (post 24, p.69) encouraged the researcher that increasing stiffness would likely reduce the sway.

These speeds may not appear to be fast, but rider effort to go this fast is greatly reduced.



I then swapped out the wheel for the 20" brushless.



This motor is dead silent. It does not have as much torque, but seems to be able to hit similar speeds. The silence is amazing. The smaller wheel seems to be more stable. Possibly since the weight is 3" closer to the ground and the wheel is a lot stiffer side to side.

This wheel and motor combination has stayed on the trailer and proven to be reliable and stable for more than 100 miles of testing.

	<p>I'm considering whether to make the effort to make a trailer that is 6" shorter for the small wheel. I want something as compact as possible, but still stable.</p>	
--	--	--

<p>3/7/11</p> <p>Hooked up the trailer to the bike with the 26 inch wheel. The batteries are bungeed to the platforms welded on last week. The throttle cable is long enough to reach the trailer, but the CA is not. I had to mount the CA onto the top tube. I need it to confirm voltage and read a speed. I might have to extend the wiring to get this to the handlebars to be safer when reading it.</p> <p>The geared motor pushed strong. 12mph up a decent hill. Up to 18 mph on the way down. As long as it was smooth, there were no issues. If it started a wag, then it stayed that way until I stopped. The wag was pretty bad at first, and I could hear the trailer to bike connection rattling at each oscillation. I tightened up these connections, so there would not be any motion other than rotation, and this with a lot of friction. This significantly improved the stiffness, and therefore cut down on oscillations. Bouncing was not as much of an issue as expected.</p>	<p>The content of this journal entry repeats a lot of what was described in post number 25. Around this point in the project, the researcher found that instead of only asking technical questions of the forum he was now sharing steps and describing progress. The community became an environment that encouraged communication. As of the writing of this commentary, 622 members have read the thread about this research. The researcher wanted to share with them.</p>
--	--

<p>26.</p>	<p><i>Re: Electric trailer research</i> <input type="checkbox"/>Posted: Mon --- --, 2011 7:22 pm by Sp----- I believe a shorter trailer assembly will be a bit 'twitchier?', and the longer arrangement would be more stable. If you shorten the length from the bike to the pivot and bring the pivot closer to the rear tire, the power of the trailer will have less leverage to try and push you over sideways when in a sharper turn. I would put a cargo box in between the trailer tire and the pivot so the cargo weight would be as low as possible (instead of on top of the trailer tire).</p> <p>I really like the 20" wheeled version, and easy to increase the power if thats whats wanted later...</p>	<p>Here a community member offers suggestions about the dynamics and configuration of the trailer. The suggestion to extend the length of the trailer to improve stability would go against several of the objectives for the product. The longer the trailer gets the harder it is to store, lock up, and maneuver. This gives more credence to the idea of an extendable trailer that could lengthen for dynamic stability but collapse for storage and when locking to a bike rack.</p>
<p>27.</p>	<p><i>Re: Electric trailer research</i> <input type="checkbox"/>Posted: Mon --- --, 2011 8:02 pm by AI----- You could use a trapezoidal bearing and effectively project the point of rotation forward to increase stability. This is how the Hensley Arrow trailer hitch works. See their website for info on this.</p>	<p>Here is an idea completely out of left field. No manufacturer has ever adapted RV technology to the hitch of a bicycle trailer.</p>
<p>28.</p>	<p><i>virtual pivot hitch</i> <input type="checkbox"/>Posted: Tue --- --, 2011 4:20 pm by Researcher <i>AI----- wrote: You could use a trapezoidal bearing and effectively project the point of rotation forward to increase stability. This is how the Hensley Arrow trailer hitch works. See their website for info on this.</i></p> <p>Great idea! I have thought of some linkage joints, but have never seen this trailer hitch. Went to the Hensley website,</p>	<p>There is great potential for a hitch of this geometry to create a radical solution for this product.</p>

looked at some competing hitches, and saw a Lego demonstration of the joint. I decided to make my own to try to see what would happen with a single wheel. I broke out the kid's Kin-ex and here is the result:

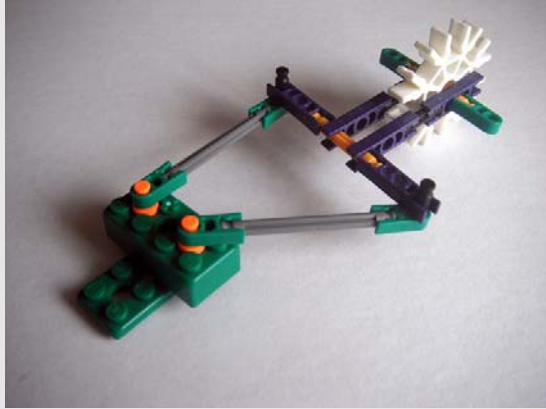

It seems to track pretty well. Rotation of the green "bike" keeps the trailer wheel (white) aimed at a point well forward of the two orange pins on the "bike". This should be aimed at the contact patch of the rear tire, or slightly forward of that. I still am not sure about the push vs. pull and forward/backward dynamics, but I think I'll need a full size demo to get a feel for that.

I'll have to break out the SolidWorks and model up a joint with the right virtual pivot, which fits in the profile of the trailer and is strong enough to take these forces. Then we'll see what Home Depot or McMaster has to contribute.

I went looking through the forum for "pivot" and "hitch", but did not come up with anything. Lots of the pics on older posts are not working, so I might have missed something.

Has anyone else tried this before?

A DIYer on a trailer forum wanted to understand the workings of this type of trailer hitch. He made a lego model of the geometry and posted it to YouTube. (tfodify, 2010) The researcher believed that making his own model would help with shrinking the design to work on a small trailer.

Small scale scratch prototyping is an effective way to quickly prove the feasibility of an idea. The decisions made in creating the model and making it work help the designer to understand some of the elements that need to be included in more refined concepts.

<p>29.</p>	<p>Re: Electric trailer research <small>Posted: Tue --- --, 2011 4:50 pm</small> by Ra-----</p> <p>Your model looks interesting, and would probably work okay on a trailer being pulled. But it looks to me like a pusher trailer would force the trapezoid into an unbalanced configuration that would result in the power wheel trying to push to one side. What happens on the model when you hold the green "bike" back with a little pressure and try to move forward by rotating the trailer wheel? If you set the wheel at an angle to the "bike" does the trailer try to straighten out?</p> <p>It also seems a little like overkill. I have pushed a bike with both one wheel and two wheel (both wheels powered) trailers and they never tried to high side the bike, even though there was some twitching on the one wheel trailers at higher speeds.</p> <p>Anyway, I'm just curious. Thanks 😊</p>	<p>Questions like these were exactly why the scratch model was important to build.</p> <p>It is interesting that the forum member is talking about "high siding," while the hitch design is intended to alleviate trailer sway. This could be due to lack of attention on his part, or lack of clarity from the researcher.</p>
<p>30.</p>	<p>Re: Electric trailer research <small>Posted: Tue --- --, 2011 9:43 pm</small> by Researcher</p> <p>It is amazingly stable when holding the green "bike" and pushing the wheel toward the "bike". The trapezoid does not fold up like I thought it would. The force from the wheel is always pushing directly toward what would be the contact patch of the rear wheel of the bike. I'll have to get either more complex with the model or set up a full size demo to test the dynamics with a two wheeled vehicle in front.</p> <p>I realize that this does seem complex. But if it offers a compact trailer with no twitching/oscillation/ at high speed or high load, then it will be worth it. The further advantage would be the ability to</p>	<p>If there is no other way to improve the stability of the trailer at high speed, the next step in the prototype will need to be a full scale model to observe the dynamics of the hitch.</p>

	<p>remove one of the linkages and be able to fold the trailer up beside the bicycle for easier chaining at a bike rack.</p> <p>Again I will ask: has anyone tried this type of hitch before?</p>	
<p>31.</p>	<p><i>Re: Electric trailer research</i> <small>Posted: Tue --- --, 2011 10:11 pm</small> by AI----</p> <p>It works amazingly well on my 10,000 pound trailer. Makes towing as calm as not towing, can't feel the wind or semi's passing. But the hitch I have weighs more than 100 pounds so putting it on the bike doesn't seem very practical. If you scale it down it should be fine.</p> <p>If it works as well on the bike as it does on the RV you almost won't be able to tell there is a trailer back there. In the name of science it certainly seems worth a try.</p>	<p>If someone else on the forum had tried this type of hitch design on a bicycle trailer, the information they could share would be very beneficial to the designer.</p>

<p>3/31/11</p> <p>At this point I find that I am not writing here as much, but have been posting on the forum instead. I want to share my observations and testing with them.</p>	
---	--

<p>32.</p>	<p><i>Re: Electric trailer research</i> <small>Posted: Wed --- --, 2011 3:59 am</small> by Bo----</p> <p>Loving the trapezoidal hitch idea - should be relatively easy straightforward to engineer too. Still hoping I'll be able to catch you up some time this week Researcher ;^)</p>	<p>This forum member has his own thread and is also building a single wheel electric pusher trailer, but with completely different components and design.</p>
-------------------	---	---

33. *Re: Electric trailer research*

Posted: Mon --- --, 2011 12:39 pm

by **Researcher**

So, with the nice weather this weekend, I wanted to take the bike out for a nice trail ride. With the roots and rocks, the trailer would have been impractical, and I wanted some exercise anyway. The trailer came off by removing two bolts, and detaching the throttle and CA connection. These wires were bundled and secured to the bike frame with some Velcro straps. So the bike was basically back to normal, with only a few extra ounces.



The ride was a lot of fun, and then this morning it took less than 2 minutes to put the trailer back on, and ride to work. This is the furthest I have taken the trailer from home, and it did great. It averaged about 20 Whr/mi, with some long hills and light pedaling. Just got home from the 2mi/70 degree commute, and no sweat or hard breathing! It would do 18mph on the flats, and still about 12mph on the hills.

Riding on sidewalks emphasized an issue that I'm not sure how to deal with. The trailer would bounce over the seams and irregularities and lose power. I have very low pressure in the tire, so it absorbs a lot of bumps, but when it regularly hits the sidewalk seams, it does start to hop. Adding a suspension could eliminate some

The ability to easily remove the trailer and return the bike to normal usage is an important feature of this product. The wires on the working prototype were the most difficult to work with. On the finished product, wires should be eliminated if possible.

20 Watt hours per mile is about average for electric bicycles. The amount of power used varies considerably depending upon rider input.

Something to reduce this bouncing will be necessary in the final product.

	<p>of this, but It would need damping of some sort that can be tuned. It has to work with a loaded or unloaded trailer. A 100% potential increase in weight means the damping/ spring force needs a lot of variability.</p> <p>In addition, it sounds terrible with the whine of the gears fluctuating so much on the bumps. The geared motor is probably not going to be the final solution for this trailer, since the brushless is so much quieter. The brushless may not really be more effective as a device, but will appear so without the noise.</p>	<p>The sound from the motor brought too much attention to the device while riding on populated sidewalks. People would turn to look as they heard the bike coming.</p>
<p>34.</p>	<p><i>Re: Electric trailer research</i> <input type="checkbox"/>Posted: Fri --- --, 2011 12:44 pm by Researcher Yesterday I swapped out the 26" geared hub motor on the trailer for the 20" brushless. Today I rode to work and amazingly the sway at high speed is nearly gone. I think it has something to do with the stiffness of the wheel itself. The spokes on the 20" are only about 4" long. I think that this reduces the side to side springiness that gets the larger wheel bouncing from side to side. I'll have to see what happens when I put my backpack back there and have more mass bouncing around.</p> <p>I also enjoyed the silence. You can barely hear the motor, at high speed it sounds like a bee buzzing away back there, but the gear whine is gone.</p> <p>I rode 11 miles today, using up the 4 batteries right as I turned into my driveway. I didn't really pedal all that much, and had some pretty big hills. At 17 Wh/mi, it is more efficient than the brushed motor, and is equivalent to 2058 mpg. My average speed was 13mph, and I peaked at 25.</p>	<p>The significant reduction in sway with the use of the smaller wheel has reduced the need for experimentation on the trapezoidal hitch. The radical hitch concept would be a feature that may increase interest in the product, but the additional testing needed to prove and refine the design are out of the scope of this project.</p> <p>The quiet operation of the brushless motor on the trailer has made it the clear choice for the design.</p>

<p>35.</p>	<p><i>Re: Electric trailer research</i> <small>Posted: Fri --- --, 2011 2:34 pm</small> by Am---- The sway is probably partly from the longer spokes (especially if they're not fully tensioned), but is also probably from the different geometry of things putting more mass at a greater height with the larger wheel.</p>	<p>More data to support the use of the smaller wheel in the product.</p>
<p>36.</p>	<p><i>Re: Electric trailer research</i> <small>Posted: Tue Apr 05, 2011 2:08 pm</small> by Researcher On a side note, has anyone been able to try out one of these? http://www.ridekick.com/</p>	<p>The researcher was curious to hear reviews on the only production pusher trailer on the market. No one has replied to this question. This is the last post in the thread, and there has been no activity for more than a month. The thread has moved pages down into the topic listing on the forum, and is therefore not being read.</p>

Project Outcome

Though this research could have concluded with a successful demonstration of the value of virtual DIY community interactions, it was important to bring the development of the concept up from a working prototype to a real product concept. The researcher has evaluated the suggestions, comments, and warnings from the prototype build and progressed into further concept development. An important part in the sequence of the design process is the collection of user needs and establishment of specifications.

User Needs

From the information gathered as shown in the project background and project implementation, a list of user needs was organized to guide the development of concepts. This set of needs is important to consolidate and organize in order that the product may demonstrate specific features that address the needs. These needs are restated here and ranked according to importance. The more dots the statement has, the more important it is.

<u>The bicycle assist device should:</u>		
Priority	#	Need Description
●●●	1	significantly reduce bicycle rider effort
●●●	2	provide power capacity sufficient for typical trips
●	3	provide feedback on remaining power
●	4	recharge quickly
●	5	be easy to initially install on user's bicycle

●●●	6	remain securely on the user's bicycle during use
●●	7	attach and detach from the user's bicycle with minimal effort
●●	8	install on a wide range of bicycles
●	9	provide space for transporting items
●	10	cost less than purchasing a quality electric bike
●●●	11	have minimal effect on the handling of the bicycle
●	12	appear as a quality, attractive system
●●	13	provide for security measures
●	14	be a compact product
●●	15	be rigid
●●	16	require minimal maintenance
●●	17	Last for a long time

Table 2: User needs

Target Specifications

With the customer needs for the device defined and ranked, the next step in the product development process is to establish target specifications for each of these needs. Needs are expressed from the customer's point of view, but product specifications are needed to provide guidance to designers and engineers. For example, the need statement that the device should "provide power sufficient for typical trips" is ambiguous. The designer would need to know the length of a typical trip and how much power is needed for a trip of this distance. This need may give rise to more than one specification. To sufficiently describe this aspect of the design, a battery capacity, power to distance efficiency number, and trip length would be required. Specifications require a list of metrics. Metrics are easy-to-measure values that can be used to evaluate the success of the design. Due to the fact that these values are likely to still be in flux at this point in the design process, the specifications are considered

“targets” and can be expected to change as the product concept becomes more defined (Ulrich & Eppinger, 2008).

Metrics for the bicycle assist device are listed in Table 3.

Metric #	Need #	Metric	Units	Marginal Value	Ideal Value
1	1	Power capability	W	500	750
2	2	Power capacity	Whr	200	300
3	3	Power remaining display legibility	Binary	Pass	Pass
4	2,4	Recharge time to 80% capacity	min	120	60
5	5	Time to initially install system	min	30	15
6	5	Tools needed to initially install system	Quan	5	3
7	6	Shock testing of attachment system	g	3	5
8	7	Time to attach to bicycle	s	30	10
9	7	Time to detach from bicycle	s	60	30
10	7	Unit mass	kg	20	12
11	8	Bicycle compatibility	list	None	All
12	9	Cargo area	sq. in	144	288
13	10	Unit manufacturing cost	\$	700	450
14	11	Lateral force supplied to connection	N	100	50
15	12	Appear as a quality, attractive system	Subj	>5	>7
16	13	Provide for security measures	Binary	Pass	Pass
17	14	Product cube	Ft ³	3	2
18	15	Connection to wheel lateral stiffness	kN/m	>50	>75
19	16	Mean time between maintenance	hrs	100	200
20	17	Charging cycles	Cycles	>700	>1000

Table 3: Metrics and target specifications

Many of these specifications can be easily evaluated, or at least estimated, by the designer during the concept generation process. However, some of the measurements will need to be tested with prototype parts very close to the production configuration of the product. For example, specification 14 requires a force test on the connection to the bicycle and will need to be tested at some point after a prototype with final geometry is created. This may take several iterations to be successful and may come late in the design process. To determine opinion on appearance, a subjective specification evaluation will require market testing with a point value ranking scale.

These specifications are important to establish before time and money are spent on generating concepts. For this product development effort, this preferred timeline was compressed at the beginning due to the fact that the research was known to require creation of a working prototype to evaluate the virtual community interaction. A skeleton framework of the product's geometry was needed to create this prototype. Though out of order, the specifications are included here to provide some standard by which to judge the success of the product concept. This project effort ends with the generation of a virtual final concept model. This level of design cannot be evaluated against all of the specifications but will be shown to satisfy many of them.

Ideation

Though the needs and metrics are not specific to any kind of solution, this project is using a compressed process specifically to demonstrate a concept for the research. This process compression required that a solution be partially developed outside of the formal design process, and the record of that procedure is not recorded here. Ideation began at a

stage where the geometry of the solution was known to be a single-wheeled trailer, and the strengths and limitations of this design had begun testing.

The basic components of the trailer were known to be batteries, controller, wheel with motor, an articulating frame, bicycle connection, display, and throttle. Accurate solid models for these components were arranged in various configurations in a CAD program, which provided a skeleton for initial form sketches. These sketches are a way to explore the shape, mass, and feel of multiple ideas very quickly.

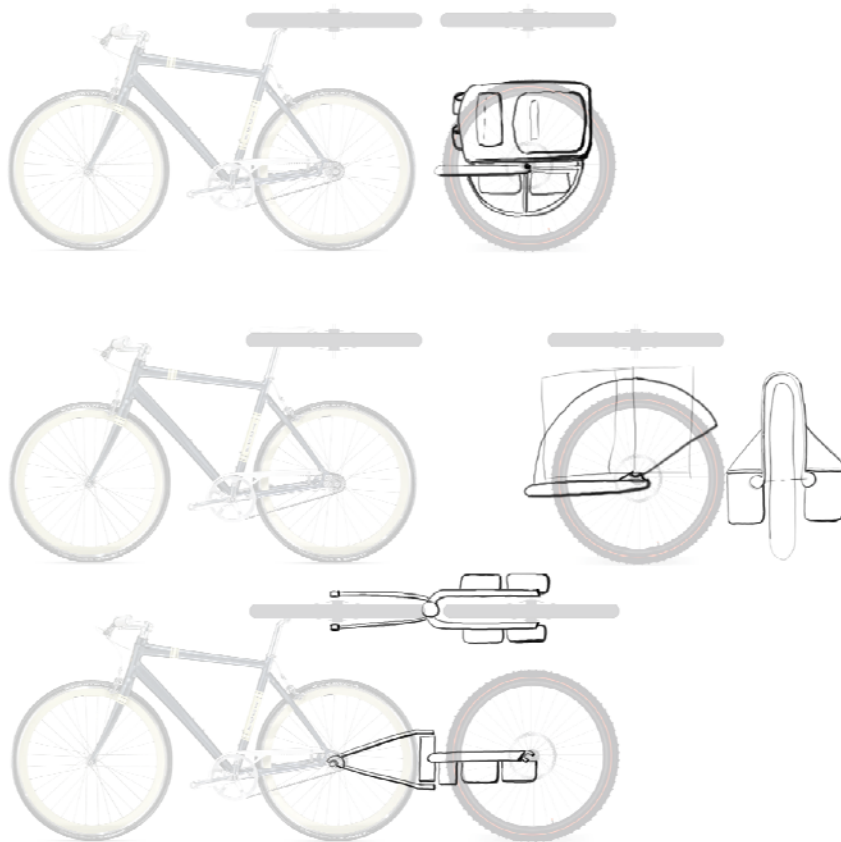

Figure 27: Initial sketches to explore geometry

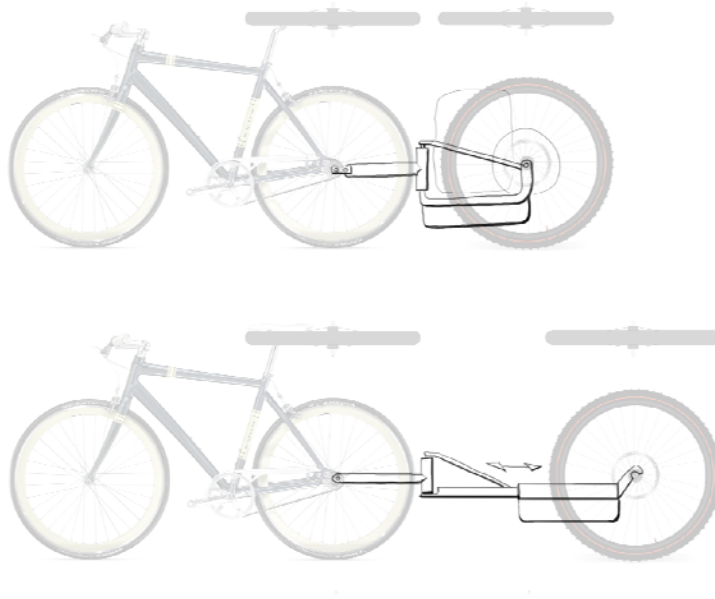

Figure 28: Additional geometry explorations

Since the device is intended to be used with any type of existing bicycle, attempting to match a single style would result in an odd appearance when paired with another. This gave the researcher freedom to create original styling for the trailer. The need for transporting cargo and the number of batteries needed for range turned out to be the most difficult design elements to incorporate.

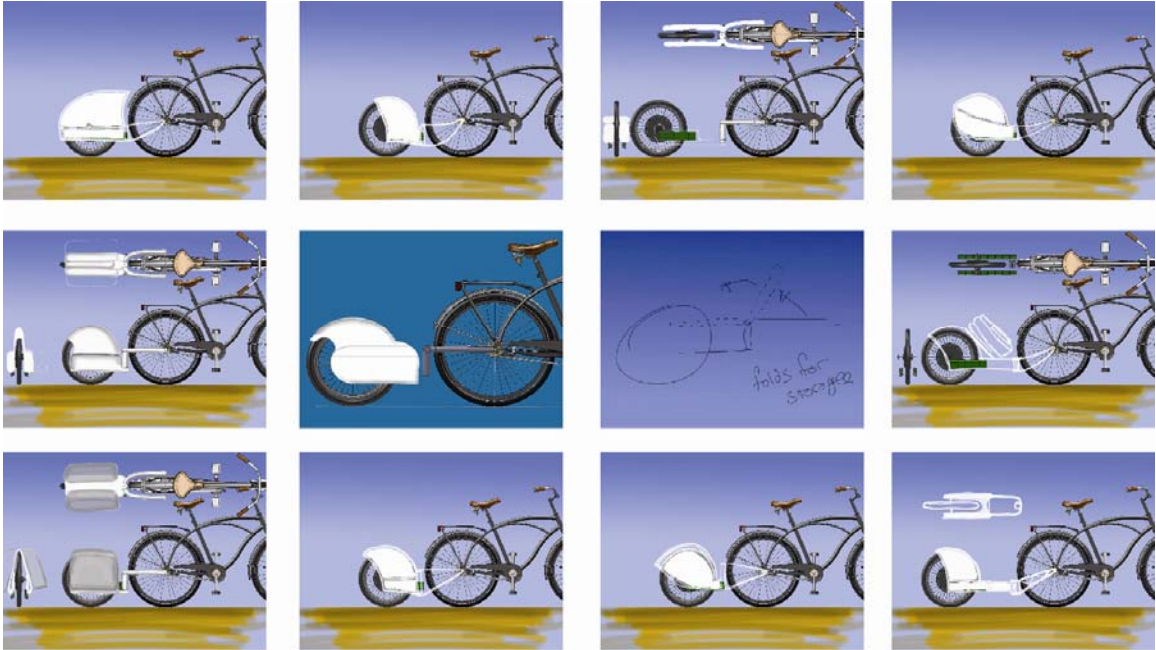

Figure 29: Form and mass sketching

Suggestions from the forum gave rise to the idea of a length-extendable trailer. The geometry change addressed the compact storage need when collapsed and, when extended, would provide more stability and cargo capacity. This concept was explored and discarded due to complexity and alternate solutions.

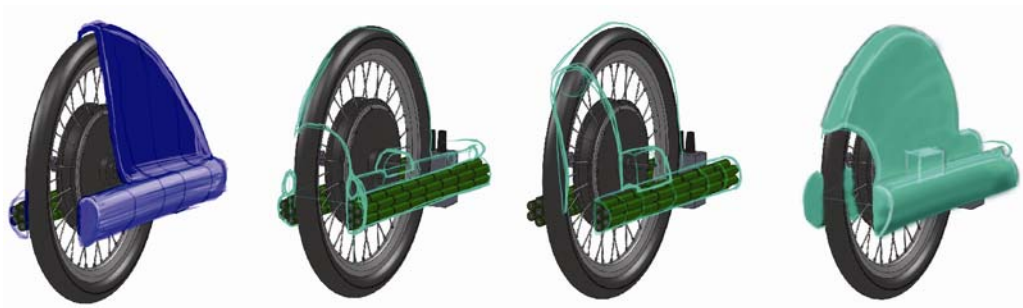

Figure 30: Exploring placement of batteries

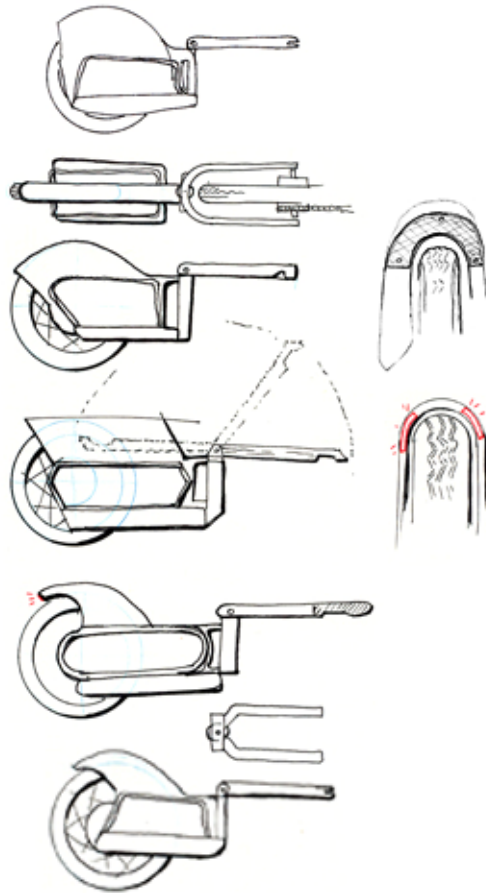

Figure 31: Form and feature concepts

The size of the trailer wheel changed as development progressed. An initial look at large diameter wheels (26") showed that they occupied too much volume. These sketch explorations considered 20" wheels and concluded with a 16" wheel. Forum members that have trailers with wheels this size use them effectively (see forum post 6 p. 51). This small-diameter wheel has two advantages: reduced volume and increased stiffness.

Concept Development

A combination of elements from the preceding sketches were selected and combined into one concept to pursue. Further ideas, forms, and features were explored with accurate models in CAD.



Figure 32: Initial CAD models of trailer with bike

It was challenging to contain all of the components in as small a volume as possible. The need to maintain the correct number of battery cells was the biggest challenge. The trailer also had to contain a suspension system to reduce the tendency to bounce over bumps and lose traction.

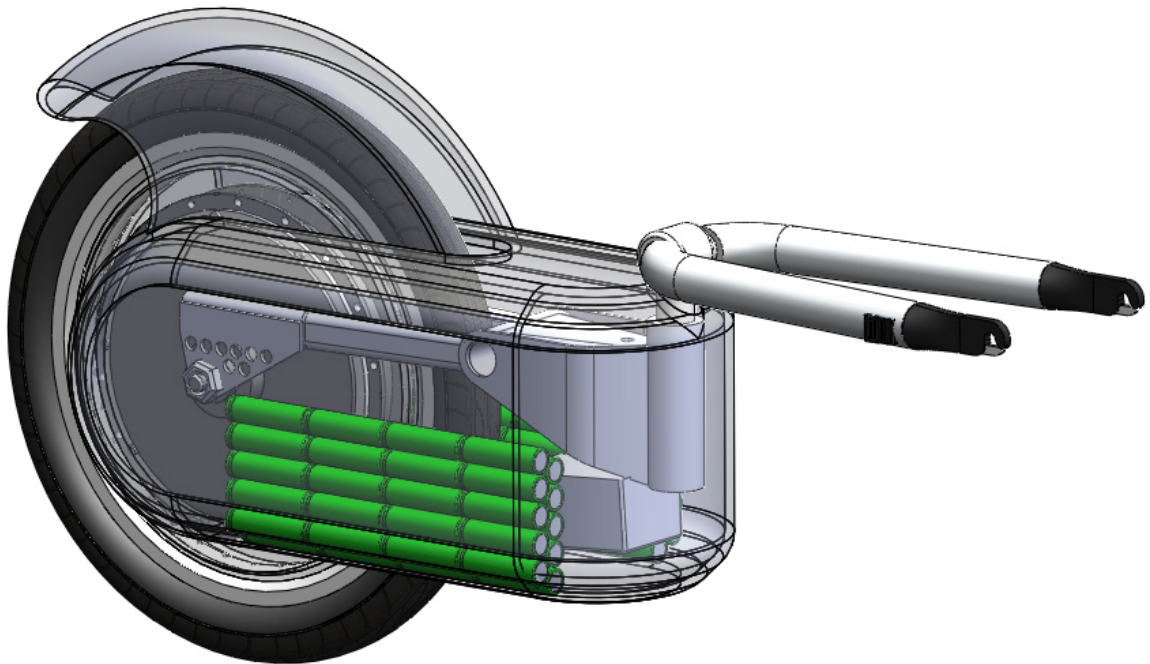

Figure 33: CAD model exploring component arrangement

Trailer enclosures that held all of the components inside one volume appeared chunky and blocky, wasting a lot of internal space. The mechanisms did not nest in a compact form. A decision was made to move the batteries to an outside container that could be formed separately. This allowed the main body to shrink to minimal dimensions. The additional advantage of this system is the ease of battery replacement.

Final Concept

The final design of the trailer has a retro feel that should look attractive behind any style of bike. The shapes reference 1940s streamlining and retro-style scooters that are becoming popular. The tapering shape helps to imply motion.



Figure 34: Final form of trailer project

The projecting sides of the trailer contain enough batteries to push most bikes up to 11 miles. Surrounding these forms is a folding shelf with openings for bungee cords to retain cargo. The suspension utilizes shock-absorbing thermoplastic to quickly dampen bouncing caused by bumps. The folding fork stores compactly but also has locking positions for multiple styles and sizes of bikes.



Figure 35: Trailer with multiple styles of bikes



Figure 36: Trailer concept in use

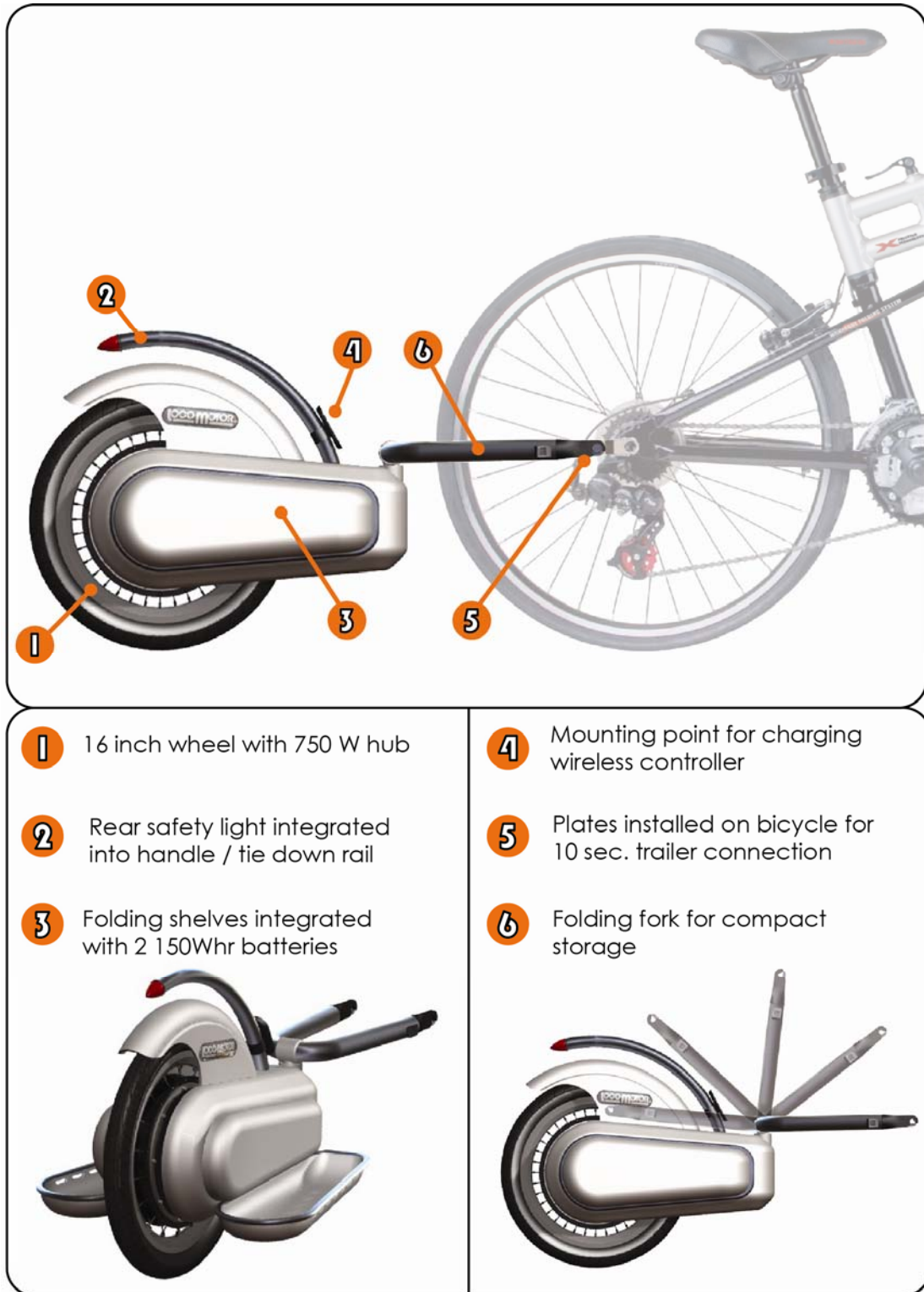

1 16 inch wheel with 750 W hub

2 Rear safety light integrated into handle / tie down rail

3 Folding shelves integrated with 2 150Whr batteries

4 Mounting point for charging wireless controller

5 Plates installed on bicycle for 10 sec. trailer connection

6 Folding fork for compact storage



Figure 37: Feature details of final concept

The trailer will be controlled by a wireless throttle clipped to the handlebars. The throttle will be combined with a display that shows the battery state of charge and basic cycle computer functions. The controller can be positioned on either handlebar with a simple reversal of the throttle lever. This wireless throttle technology is already available in many remote control products. The wireless bike computer is one of the latest features out on the market.



Figure 38: Wireless controller concept in use



Figure 39: Wireless throttle and display

Important to the functionality of the trailer is the charging process. Charging should be done after each ride to make sure that the device is ready for the next use. The batteries in the trailer must be charged with a powerful, smart charger. In addition to the main packs, the controller also needs to be topped off. This will happen while the trailer is sitting on the charger with the controller clipped into its spot. The display on the controller will automatically display charging information. The charging process will be automatic when the trailer is placed onto the charger.



Figure 40: Trailer being charged

This bike trailer not only is attractive and intriguing but should satisfy the needs documented in Table 2: User needs. The following table describes the solutions that address each of these needs:

#	Need Description	Solution
1	significantly reduce bicycle rider effort	Peddalling encouraged, not necessary
2	provide power capacity sufficient for typical trips	300 Whr system can push the bike 10+ miles, depending on rider effort
3	provide feedback on remaining power	Controller display indicates state of battery charge
4	recharge quickly	Batteries should fully recharge in two hours or less
5	be easy to initially install on user's bicycle	Two simple bolt-on plates should require 10 minutes for initial install
6	remain securely on the user's bicycle during use	Locking mechanism retains trailer
7	attach and detach from the user's bicycle with minimal effort	Attachment or removal should take 10 seconds or less
8	install on a wide range of bicycles	Bolt-on plates designed to fit most bicycles
9	provide space for transporting items	Fold-down shelves can support backpacks, briefcases, and bags
10	cost less than a quality electric bike	Estimated price under \$500
11	have minimal effect on the handling of the bicycle	Dynamic testing shows minimal changes to bicycle handling
12	appear as a quality, attractive system	Injection moulded body and integral accessories appear attractive
13	provide for security measures	Spoked wheel allows for cable lock
14	be a compact product	16" wheel and folding fork create a small, compact system.
15	be rigid	Small, stiff wheel and oversized tubing produce a rigid system
16	require minimal maintenance	Other than charging, the system should require no maintenance for two years
17	Last for a long time	Depending on use, the system should last for 2000 charges, or 5 years if charged daily.

Table 4: Addressed needs

One of the final elements in the development process is to give a name to the concept. This name should be unique in the market and signify something about the product's function. The name chosen reflects two particular references that relate to the product. The first is the Art Deco influence of the design. A classic example of this type of design is the train locomotives from the 30's and 40's.



Figure 41: Streamlined Art Deco locomotive

The other influence on the name is the comments that have been heard as the prototype was tested. Bystanders would ask “What is that?” and after hearing the purpose of the device would yell “That’s crazy!” The product will therefore be called the “LocoMotor”



Figure 42: Product logo

Overall the concept is a success, and the project is an effective demonstration of the benefits of designing amongst DIY communities.

Observations and Recommendations

Types of Assistance

The industrial designer involved with DIY communities during the design process can expect to see various benefits from the interaction. DIY users can assist with encouragement, information, advice, and inspiration. The following section gives descriptions of the types of assistance that this researcher has experienced in these virtual communities.

Encouragement

One of the main reasons that forum members peruse the threads is to see what others are working on. It is encouraging to see others working on the same types of design problems. In addition to this feeling of solidarity, there is direct encouragement as fellow DIYers post thread replies like “good luck with your trailer build” (post 2, p. 47), “looking forward to the pusher build” (post 17 p. 64), and “nice job on the test trailer” (post 27, p. 74). While these statements are not of any direct assistance, knowing that there are others following the progress does help with motivation. It may also build courage in the designer to take on challenges knowing that there is a wealth of knowledge and support available.

Links to Other Informational Sites

Forum members, as a general rule, are helpful and not very territorial. This can be contrasted with the need for protection of proprietary knowledge found with profit-driven

companies. Apple is notorious for secrecy in its product design process, even to the extent of firing workers that distribute any data (Stone, & Vance, 2009). However, this isolation goes against the philosophy of these sharing communities. One of the main reasons that these forums exist is for members to share knowledge and experience. If this experience happens to exist somewhere else on the web, then there is nothing stopping them from directing other members there. The “not invented here” tendencies in a corporate environment would not be helpful to these individuals seeking knowledge and camaraderie.

As an example, consider a forum member who posted a technical schematic asking about how to do some wiring. A single reply more than one month later recognizes that there has been little help on that forum and suggests a different forum to ask the questions. Frequently, links like this are posted in replies with directions to alternate sources of information. A Google search may not always pull up these relevant results, and if it does then the individual must sift through the results. Joining a community enables the designer to tap into the “who knows who” method of finding the right source. The thousands of others who are interested in the same topic are also using the web to track down similar information. This type of assistance works as a targeted intelligent search for relevant websites, companies, and people, and would benefit industrial designers by directing them to information that is otherwise difficult to find.

Links to Products

In addition to information links available from DIYers, forum members test and evaluate many different products. As an example, the thousands of members of the electric bike forum that have built their own bikes all have batteries, motors, and motor controllers of

some sort. This means each one of them has product selection and use experience relevant to an electric bike designer. The same could be true in other forums for a designer working on any number of other product types. In the case study project, a controller with specific capabilities was difficult for the researcher to find. His lack of knowledge and experience made searching through the multiple product listings confusing and unfruitful. The posting by the forum member in response to this described need (forum post 14, p. 61) was a link to a product that fit the unusual criteria. By using DIY forums in this way, industrial designers can expect to find similar assistance with their own projects.

Context Specific Searches

Registration on forum sites frequently unlocks search functions that are not available to guests. These “members only” searches at forum sites can bring up information that is not available from the major search engines. The results of these searches will be records of conversations between potential contacts that may be able to assist the designer.

The first used parts the researcher received from eBay came with no instructions or documentation. They had been originally installed on an electric bike called a “Calypso.” General internet searches did not find any information on the components. However, a search for the same key word on the DIY forum showed that another user had the same type of equipment. This context-specific search enabled contact with a user that had potential useful information.

Non-COTS (Commercial-Off-the-Shelf) Parts

The researcher was able to purchase a customized electronic assembly from a forum member that enabled him to use the power drill batteries in an application for which they were

not intended. This product, a printed circuit board (PCB), was created by member Kf----- to meet Kf-----'s own need for such a solution. The circuit and components were developed by this member specifically to interface with the drill batteries for electric bike use (see forum post 3 p. 47 and journal article from 2/3/11 p. 49). It turned out that this solution also met the needs of multiple DIYers that were interested in the same capabilities. Scanning through older postings, it became evident that Kf----- sold several batches of these boards. He was offering boards that were assembled, or as a bare PCB with a component list to be ordered separately. The product was a result of applying his specific skill set to his own problems and then finding that there was a market for the result. Without this product, the researcher would have had to spend significantly more money on a retail battery solution.

The researcher observed this type of topic-tailored product in several different communities. On more than one motorcycle forum, a member with machining skills has made custom parts for himself. After reading a posted description of the problem the parts solve, others have been interested in purchasing some for themselves. On KLR650.net, a member named eaglemike has created multiple products that are valuable to other riders for motorcycle modification. One thread is a discussion of a fork brace that many riders have purchased to correct a weakness in the manufactured product (Site requires registration for full access) (brims, 2011). Products like these can either be valuable to a designer to assist with prototype builds or serve as inspiration for features that should be included on the product under design.

Inspiration to Innovate

If there is a problem or limitation in the vast array of products offered on the retail market, it is likely that a DIYer has tried to make improvements. The wide range of interests

of DIYers overlaps most of the potential areas industrial designers will be working on. Whatever designers are involved in improving or creating, DIY solutions to the problem can be a good source of inspiration. Whether it is an elegant solution, a failed attempt, discussion about testing methods, an innovative material choice, or a new way of approaching the problem, DIY efforts can stimulate an industrial designer's creativity.

When the researcher was considering concepts for this design project, the ideas from DIY builders supplied fresh thoughts on how to solve existing product problems. As described in the first forum post above, a DIYer using DeWalt batteries to power an electric bike was the first prompting to consider these batteries for prototyping. Additional ideas were considered as forum members shared about their own trailer builds.

This inspiration is not limited to the electric bicycle topic. During a design studio project working on generators, the force required to pull start the engines was identified as a problem. While researching ideas to reduce this effort, the researcher discovered a DIY solution for a "pull start eliminator." The design involved an electric drill and an adapter and removal of some safety shields (Hunter, 2009). While this method is now labeled as "patent pending" and is not appropriate for the mass market, the design was able to inspire ideas that were appropriate for OEM instead of a retrofit.

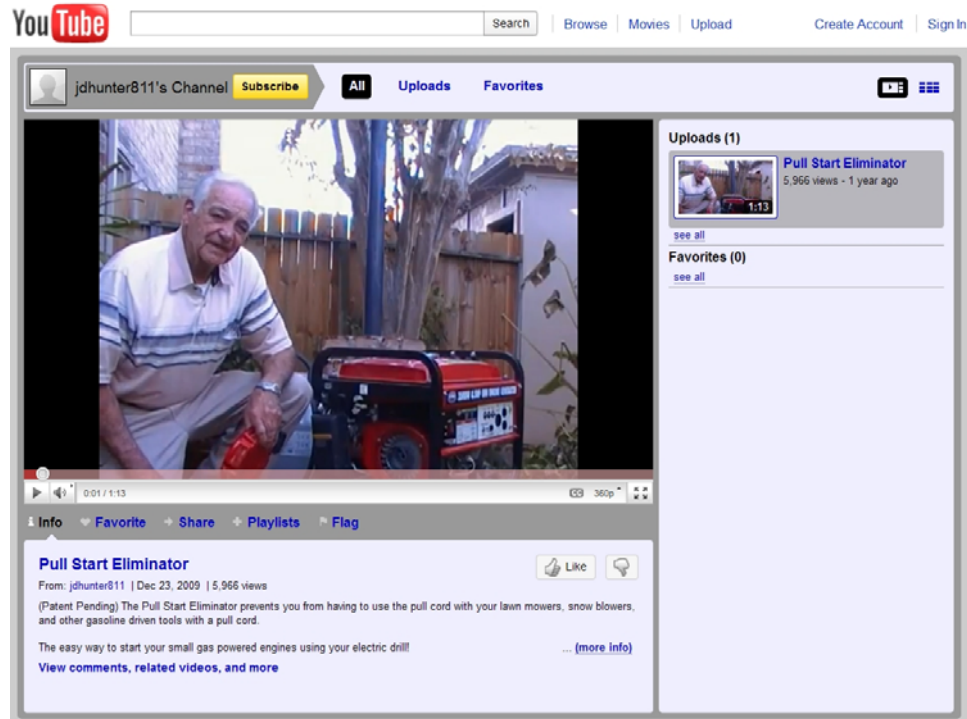

Figure 43: YouTube video of inspiring concept

Caution

Because the very nature of DIY is to experiment until something works, the community is saturated with failed concepts. Camaraderie is created amongst community members in the shared understanding of the frustration of failed experiments. When a member proposes to try something that has failed for another, the experienced DIYer will describe the difficulties to attempt to prevent wasted time and money. This is a great advantage to designers. Proposing concepts is second nature to industrial designers, and the forum is a wonderful place for critique. Ideas at any stage of development can be posted, and many members will be available to help. This electric bike project demonstrated this principle with the immediate and continued cautions from forum members about the length of the trailer.

Technical knowledge and nomenclature

When an industrial designer starts a new project, a great deal must be learned in a short time. Technical knowledge of how the product works and is used is vital, as well as the way the product fits into a user's lifestyle. Important to this ethnography is vocabulary. A researcher with a current colloquial vocabulary can "talk the talk" familiar to users in the product usage environment. Sounding more informed and being able to understand lingo will assist in gathering information from users.

Since DIY forums are a conversational interchange that often includes technical information, they are an excellent primer for understanding new terms and how they are used. Due to the inviting nature of these communities, it is perfectly normal to ask a question like "what does this term mean?" If this method does not seem appropriate, it is easy to search for the term and read conversations to see the term used in context.

The researcher learned significant numbers of common terms and acronyms that were frequently used in forum conversations. For example, "sag like mad" refers to the tendency of cheap batteries to drop in available voltage when heavily loaded. SLA's, BMS's, lipos and Ah's are terms in frequent use when referring to electric bicycles. Familiarity with the terminology is an advantage to the designer.

"How to" information

The researcher needed to install electrical connectors between various components in the trailer project. His unfamiliarity with the Anderson Powerpole product led to mistakes in the assembly. This type of mistake is common for a designer when working with unfamiliar

equipment and components. These mistakes must also be common to DIYers, as there are many “how to” explanations that permeate the web. The advantage to working amongst DIY communities is that the members frequently take the initiative to document usage and assembly information. The advantage of this DIY documentation is demonstrated by the assistance available to the researcher from a video by a DIYer recorded in the 2/10/11 journal entry on p.52.

Disadvantages and Limitations

Lack of control

The researcher’s expectation when proposing this research was a large number of responses to each post. There were actually quite few. In fact, some direct questions were never answered. Fortunately, the responses that did appear were helpful and effective. This issue does highlight a disadvantage to this approach: the lack of control due to the strictly voluntary participation in the forums.

Forums are public access conversations with members that will most likely never meet in person. There is no real incentive for members to post other than the sense of helping out the community. A large number of forum members are not really a member of the community since they only read and do not interact. An analysis of the membership on the “V is for Voltage” electric vehicle forums shows that out of 22,045 members, there are 16,263 that have never posted anything. In fact, over 95% of the registered users on the forum are considered “newbies” with less than 20 posts. However, this leaves 1195 active DIYers with the opportunity to read a designer’s posts and who have a history of contribution. It would be difficult to reach this many people with any other method of research, but these communities do not give the design researcher much control.

Spam

A majority of forums require registration with an email address in order to join the community and post messages. The researcher discovered a noticeable increase in the amount of spam received at the email address used for this research. It may be prudent for the designer attempting this kind of research to create a sacrificial email account before forum registration.

Information discovery limitations

The search function on forums is not as powerful as the complex algorithms in use by the major search engines. The researcher found that using the searches returned findings that were not always appropriate. The results link to specific posts somewhere in the chronological recording of a thread. The history of these threads then needed to be explored to understand if the information was useful. This was time consuming.

Site reliability

During this project, the main forum that was being used for information went down for several days. This means that something happened to the server where the data is stored, and the site was unavailable. This has happened occasionally in the researchers experience with other forums as well. A Google search for “forum is down” returned “about 178,000” results, revealing that the problem is not uncommon. Fortunately, the interruption in service for most forums is short. The researcher’s main forum was back within three days with no loss of data. This is not always the case, so it may be prudent for a designer using this approach to copy threads to their own computer.

Recommendations

This research is intended as an exploration and example of what is possible with this type of interaction. It is not a rigorous scientific vetting of the best method to perform DIY research. Though there is only one case study to reference, the researcher's experience provides opportunities to comment on elements of an approach to benefit from these communities. This section should be treated as a set of recommendations for designers interested in exploring this approach.

A designer tasked with a new product design must first consider where to find information about the subject. When searching for DIY communities, consider that your topic is not just the overall product that you are designing. Consider thinking smaller to the components that make it up, as well as larger to other products that might contain or interact with the project in question. Also consider looking for parallel products that may use similar components to achieve different goals. In the example project, the researcher discovered sites that attracted DIY bike builders, trailer builders, and electric bike builders. Some were more focused on energy storage, and some were more interested in the welding of the bike frames. Searches for communities interested in the components of the system produced good targeted information. The researcher also found DIY electric car, remote control vehicles, and robot focused communities that discussed similar components and contained valuable information.

Look for site statistics that show how active a community is, and read several threads to get a feel for the atmosphere of the site. The more people there are that post, and the frequency with which they communicate are a good indication as to how fast replies will be available. Some of the forums that the researcher posted on garnered no replies at all. Each

community also creates a unique environment. Some are very technical, while others are conversational, and occasionally sites can become hostile. Gauging a forum's activity and atmosphere and selecting appropriately will improve the comfort of designers new to this format.

Initially start with postings on multiple sites, and see what kind of rapport develops. The researcher quickly narrowed his postings down to one site that had frequent, helpful responses. However, be cautious of copying posts in too many forums. Many of the DIY individuals are members of multiple forums. If they see the same message in many places, they may consider you a spammer and gather support to shun you. If possible, posts should be tailored to the community in which they are posted and kept respectful.

Consider starting a new thread specific to the new design instead of asking many questions on other user's threads discussing similar topics. A discouraged practice on forums is called "hijacking." This happens when a forum member other than the thread originator changes the topic of the conversation. It is respectful to the members to consider the first poster to be the owner of the thread. A designer should start a thread specific to their own topic. It is acceptable to refer people from other threads to your own.

Though it will be difficult to keep up with multiple forums and to remember what has been posted to each, it will quickly become obvious which forums will be best suited to assist. These forums will have quick, helpful responses and members that are willing to guide new members as they learn about the topic and the forum. After several rounds of posting and reading replies, the designer should be able to choose one or two sites that they can commit to for the life of the project.

It is important to focus on a very small number of sites in order to build some rapport with members as post numbers increase. Frequent posts to a thread will keep it at the top of the topic list that is displayed with the newest posts at the top. It also allows for branching out into other related topics and post on other's threads. Active members will be posting on threads throughout the forum, and the information that is shared on alternate threads can be pertinent and helpful. With postings in multiple threads, members of the forum will begin to recognize the designer as an active valuable member. This may increase the number of people that read the designer's posts and encourage replies.

As the time spent on the forum accumulates, the personalities and expertise of specific forum members will become evident. As shown in this project (post 2, p. 47) one forum member had built ten trailers for his bike. This member could be a knowledgeable contributor to other elements in the design process. A designer should note the user names of the most helpful forum members for later contact.

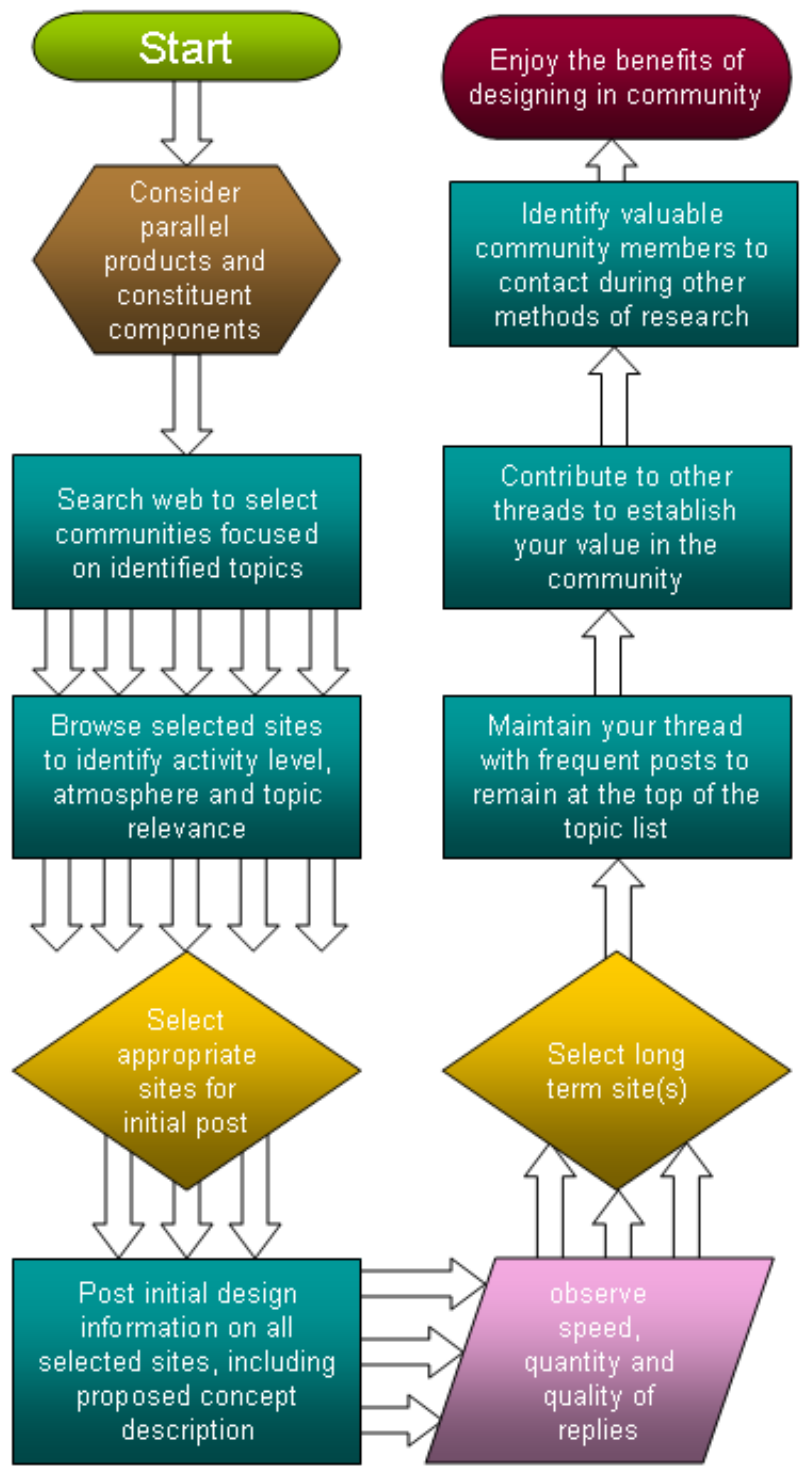

Figure 44: Recommended process for designing amongst virtual communities

The designer found that maintaining a separate blog about the design process and inviting people from forums was not worthwhile. The information on the threads received far more reads and replies than the blog.

The technology that enables the internet and resulting virtual communities is relatively young. As technology develops and permeates global society, it is likely that more people will have access to DIY communities like these. The researcher believes that internet groups will continue to grow, and that information contribution and retrieval from such sites will continue to become easier. An industrial designer's access to this resource should prove to be an increasingly valuable tool in the design process.

Above all, the researcher hopes that the information presented here provides encouragement for industrial designers to become involved in DIY virtual communities and benefit from the resources available there.

References

- About instructables.* (2011). Retrieved from <http://www.instructables.com/about/>
- anndan85 (Designer). (2007). *Battery holder for devald dc9360 ebike.* [Web]. Retrieved from <http://www.youtube.com/user/anndan85#p/u/6/DDNHntWYhEI>
- Atkinson, P. (2006). Do it yourself: democracy and design. *Journal of Design History*, 19(1), 1-10.
- Bicycle trailer guide.* (n.d.). Retrieved from <http://www.bikesatwork.com/hauling-cargo-by-bike/bicycle-trailer-guide-2.html>
- Blood, R. (2000, September). weblogs: a history and perspective [Web log message]. Retrieved from http://www.rebeccablood.net/essays/weblog_history.html
- brims, (2011, may 19). Eagle mike fork brace with stock fender [Online Forum Comment]. Retrieved from <http://www.klr650.net/forums/showthread.php?t=91756>
- Christakis, N.A., & Fowler, J.H. (2009). *Connected: the surprising power of our social networks and how they shape our lives.* New York, NY: Little, Brown and Company.
- Cyclemotor installation.* (2007). Retrieved from <http://www.neodymics.com/installation.htm>
- Cyprus, S. (2011, March 14). *What is an internet forum.* Retrieved from <http://www.wisegeek.com/what-is-an-internet-forum.htm>
- Davis, W. (2007). *Bicycle trailers.* Retrieved from <http://practicalpedal.com/summer2007/trailers.php>
- Franco, V. (2011). *Victor's r2d2 building diary.* Retrieved from <http://vfranco.blogspot.com/search/label/Droid2>
- Google groups.* (2011). Retrieved from <http://groups.google.com/groups/dir?sel=lang%3Den%2Ctopic%3D46619&q=cyclin g&>
- Howe, W. (2010, March 4). *A brief history of the internet.* Retrieved from <http://www.walthowe.com/navnet/history.html>
- Hunter, J. (Designer). (2009). *Pull start eliminator.* [Web]. Retrieved from <http://www.youtube.com/user/jdhunter811>

- Instructables statistics*. (2011). Retrieved from <http://www.instructables.com/community/Instructables-Statistics/>
- Optibike 850r*. (2010). Retrieved from <http://optibike.com/Optibike-850R.html>
- Rheingold, H. (1993). *The virtual community: homesteading on the electronic frontier* [online version]. Retrieved from <http://www.rheingold.com/vc/book/index.html>
- Ridekick: electric-powered bike booster*. (2010). Retrieved from <http://www.ridekick.com/>
- Spencer, A. (2005). *Diy: the rise of lo-fi culture*. London: Marion Boyars Publishers Ltd.
- Stone, B, & Vance, A. (2009, June 22). Apple's obsession with secrecy grows stronger. *New York Times*, p. B1.
- Tapscott, D, & Williams, A. (2006). *Wikinomics: how mass collaboration changes everything*. New York, NY: Portfolio.
- Teal, T. (2006). Scissors and glue: punk fanzines and the creation of a diy aesthetic. *Journal of Design History*, 19(1), 69-83.
- tfodify. (2010, May 19). Propride/hensley lego model - youtube video [Online Forum Comment]. Retrieved from <http://www.trailerlife.com/forums/index.cfm/fuseaction/thread/tid/23949814.cfm>
- “Low speed electric bicycle” Title 15 U.S. Code, Sec. 2085. 2010 ed.
- U.S. Department of Transportation, Federal Highway Administration. (2008). *Our nations highways 2008* (FHWA-PL-08-021). Retrieved from <http://www.fhwa.dot.gov/policyinformation/pubs/pl08021/pdf/onh.pdf>
- Ulrich, K. T., & Eppinger, S. D. (2008). *Product design and development*. New York, NY: McGraw Hill Higher Education.
- Wilson, S.S. (1973, March). Bicycle technology. *Scientific American*, 81-91.