

**Neuroprotective effects of carnitinoid antioxidants in rodent models
of mitochondrial dysfunction**

by

Michelle E. Hoffman

A thesis submitted to the Graduate Faculty of
Auburn University
in partial fulfillment of the
requirements for the Degree of
Master of Science

Auburn, Alabama
August 6, 2016

Keywords: Rotenone, Parkinson's, Mitochondria, Neuromotor

Approved by

Michael H. Irwin, Chair, Research Professor of Pathobiology
Michael Greene, Assistant Professor of Nutrition
Chad Foradori, Assistant Professor of Anatomy, Physiology and Pharmacology
James Wright, Professor of Pathobiology

Abstract

The pathological effects of mitochondrial dysfunction result from both oxidative damage and bioenergetic deficiency, and are more severe in cells and tissues with high metabolic energy demands such as neurons, skeletal muscle and cardiac muscle. In this context, our research efforts have focused on a group of proprietary synthetic lipoylcarnitine and butyrylcarnitine derivatives (PMX compounds) as potential therapies to minimize oxidative damage and maximize mitochondrial energy production in animal models of mitochondrial disease. The rotenone-induced rat model of Parkinson's disease (PD) was selected for its established inhibition/disruption of mitochondrial complex I leading to PD-like symptoms including bradykinesia, postural instability, and/or rigidity. By applying a broad spectrum battery of neuromotor tests our goal was to correlate quantifiable neuromotor performance to neuronal lesioning seen in the substantia nigra *pars compacta* (SNpc) of this model, creating an informative preclinical evaluation of potential therapeutic compounds. Tyrosine hydroxylase immunolabeling of SNpc from rotenone treated rats showed decreased dopaminergic neuronal population co-administration using PMX-500FI (lipoylcarnitine) or PMX-550DBr (butyrylcarnitine) protected against loss of tyrosine hydroxylase immunoreactive neurons in the SNpc. Additionally, similar experiments were performed with the transgenic *PARK2* mouse, a model of autosomal-recessive juvenile PD selected for its parkin protein deficiency. These mice display PD-like symptoms due to disruption of mitochondrial recycling, which allows dysfunctional mitochondria to remain. We

further challenged these mice with rotenone in hopes of creating a more robust mouse model to evaluate the therapeutic effect of antioxidant compounds.

Acknowledgments

I would first like to thank my graduate advisor Dr. Michael Irwin. The door to Dr. Irwin's office was always open whenever I ran into a trouble spot or had a question about my research or writing. He consistently allowed this project to be my own work, but helped steer me in the right direction with the utmost patience and encouragement. Also, I owe a debt of gratitude to my labmates, particularly Dr. Brett Augsburg for being a sounding board and Shannon Helsper for countless hours assisting me with rat-wrangling.

I would also like to thank my graduate committee: Dr. Chad Foradori, Dr. Michael Greene, and Dr. James Wright for their support along the way. In addition, I'd like to acknowledge the contributions of the Foradori Lab for performing IHC analysis on brain samples, and the Greene Lab for assisting with metabolic cage tracking.

I would also like to acknowledge PhenoMatriX, Inc. for supplying the PMX compounds studied throughout this work and note that none of this research would have been possible without a generous grant from the MitoCure Foundation.

Finally, I must express my very profound gratitude to my husband for providing me with unfailing support and continuous encouragement throughout the process of researching and writing this thesis. Thank you.

Table of Contents

Abstract.....	ii
Acknowledgments	iv
List of Tables	vi
List of Figures	vii
Introduction	1
Methods	8
Results	22
Discussion	32
Conclusion	38
References	39

List of Tables

Table 1	12
Table 2	13
Table 3	15

List of Figures

Figure 1	8
Figure 2	9
Figure 3	11
Figure 4	12
Figure 5	13
Figure 6	15
Figure 7	23
Figure 8	25
Figure 9	26
Figure 10	26
Figure 11	27
Figure 12	28
Figure 13	30
Figure 14	31
Figure 15	32

INTRODUCTION

Mitochondria are commonly known as “the powerhouses of the cell”. They are the primary source of cellular metabolic energy in eukaryotes through the physiological process of respiration and are essential for normal cellular function, proliferation and survival. Mitochondrial damage in tissues with high energy requirements is especially harmful and is implicated in a variety of human neurodegenerative diseases that affect both the young and old (Celardo et al., 2014; Wallace, 2010). Disruption of mitochondrial complex I (CI; NADH-CoQ reductase) of the mitochondrial electron transport chain (ETC) is a major contributor of reactive oxygen species (ROS), which can inflict oxidative damage to mitochondrial proteins, lipids and DNA, resulting in cell death by triggering intrinsic pro-apoptotic pathways (Imaizumi et al., 2015; Perier et al., 2005). As the largest ETC enzyme complex and the entry point of high energy electrons that affords maximum proton translocation, CI is a critical initiator of mitochondrial energy transfer. Deficits in CI lead to a reduction in overall energy throughput and can result in excessive generation of ROS such as superoxide and reactive nitrogen species (e.g., peroxynitrites), which can lead to a variety of human neuropathological conditions (Sharma et al., 2009). Experimentally induced CI inhibition in laboratory animals results in deficient cellular and neurobehavioral phenotypes – conditions present also in neurodegenerative diseases such as Mitochondrial Encephalomyopathy, Lactic Acidosis, and Stroke-like episodes (MELAS); Leigh’s disease; Alzheimer’s disease (AD) and Parkinson’s disease (PD) (Irwin et al., 2013; Luo et al., 2015;

Pickrell et al., 2013). While MELAS and Leigh's disease are less common, AD affects more than 5 million people in the United States alone (www.alz.org), while PD affects at least one million people in the United States and five million people worldwide (www.michaeljfox.org).

It was previously demonstrated by our lab that a novel synthetic antioxidant, PMX-500FI (lipoyl-L-carnitine methyl ester iodide), protected against rotenone-induced impairment of neuronal function in the mouse hippocampus (Parameshwaran et al., 2015). Oxidative stress and neuromotor defects were also reduced by PMX-500FI in rotenone-treated mice (Parameshwaran et al., 2012). The present work assessed neuroprotection in the rat-rotenone model of mitochondrial dysfunction-induced PD and the transgenic mouse *Park2*^{tm1SHn} model of juvenile PD (hereafter referred to as "*PARK2*" mice). Additional compounds, PMX-500DBr (lipoyl-L-carnitine ethyl ester bromide), PMX-550B (butyryl-L-carnitine hydrochloride), and PMX-550DBr (butyryl-L-carnitine ethyl ester bromide), were also evaluated in these animal models.

Mitochondrial dysfunction leading to the death of dopaminergic neurons of the ventral substantia nigra *pars compacta* (SNpc) area of the brain is associated with PD (Jenner and Jenner, 1991; Kösel et al., 1999; Reeve et al., 2013). Dopaminergic neurons like those found in the SNpc are thought to be particularly vulnerable to oxidative stress due to their high basal rate of oxygen metabolism, high iron content, and insufficient cellular antioxidants (Chinta and Andersen, 2005). Because of the demonstrable neurodegeneration of SNpc neurons in some PD rodent models, they are useful in evaluating potential treatments - not only for PD, but also for the many other diseases that are associated with mitochondrial dysfunction. PD may be regarded as a representative disease in terms of neurological effects of energy metabolism defects and specific CI decline-associated neuropathies (Chaturvedi and Beal, 2013; Perier et al., 2005). As such, the

rat-rotenone model is of tremendous value in evaluating potential therapies for mitochondrial disease. However, although rotenone is clearly a specific and irreversible inhibitor of CI, its ability to cause microtubule depolymerization should not be discounted in terms of its potential to affect neuronal function (Jiang et al., 2006; Ren and Feng, 2007). In addition, there is evidence that at least part of the rotenone-induced phenotype in rodent models is due to a general systemic toxicity effect that bears no relevance to PD-like symptoms (Lapointe et al., 2004). Furthermore, the complex interaction of environment and genetics contributing to spontaneous idiopathic cases of PD should discourage one from presuming the absolute utility of any one model for the study of this disease (Ali et al., 2011).

Most cases of PD are sporadic with no definitive cause, however some families show a Mendelian pattern of inherited Parkinsonism. Mutations in the human parkin gene are responsible for autosomal recessive juvenile parkinsonism, a heritable form of PD (Kitada et al., 1998). The transgenic *PARK2* mouse has been genetically modified to introduce a frame shift mutation and premature stop codon into exon3 of the *PARK2* gene, leading to a truncated parkin protein (Goldberg et al., 2003). Though the *PARK2* mouse is a model of autosomal-recessive juvenile PD, these mice normally display PD-like symptoms only at advanced age (> 24 months). Little data existed on testing of younger adult mice (as were used in our pilot experiments due to time and housing constraints) and we were unable to discern neuromotor or behavioral changes in these mice when housed in metabolic cages using the Promethion™ (Sable Systems International) system. This system provides computer monitoring of food and water intake by measuring changes in weight of the food hopper and water bottle, it estimates physical activity as distance traveled in the cage by beam breaks, and measures energy expenditure by indirect

calorimetry (Chen et al., 2014). It was found that cells isolated from other parkin null mice displayed increased sensitivity to mitochondrial toxins (Casarejos et al., 2006), which led us to modify our approach to include challenge with rotenone. Because these mice lack a full-length copy of parkin, a key protein involved mitophagy (Narendra et al., 2008), we hypothesized that they would display an increased sensitivity to rotenone. The nature of the mutation in these mice also gave us a molecular pathway to investigate in regard to whether the experimental PMX compounds are able to improve the dysfunctional mitophagy process.

PD neurodegeneration that leads to a disruption of neuromotor function in humans also manifests similar symptoms in rodents such as such as bradykinesia, muscle rigidity, postural instability, and unsteady gait (Wrangel et al., 2015). While neuromotor evaluation is common in rodent models of neurodegeneration, many studies often rely on as few as one test and there is no discernable consensus as to which tests afford the best evaluation for the model. An additional aim of our work has been to validate a battery of neuromotor tests that are relatively easy to administer and interpret in the laboratory setting and capable of assessing strength, stamina, coordination, and balance in rodent models of mitochondria dysfunction. Correlating improved neuromotor function to neuroprotective capability would provide a valuable tool for measuring the effectiveness of potential therapies to improve mitochondrial function and provide symptom relief.

For the work presented here we made slight modifications to a well-documented protocol for producing a PD-like phenotype in Lewis rats using rotenone (Cannon et al., 2009) and applied this model for *in vivo* testing of a unique group of small molecule carnitinoid compounds that were developed specifically to protect cells in mitochondrial disease and other diseases

associated with mitochondrial dysfunction (Irwin et al., 2016; Steliou et al., 2015). The compounds used in this study (PMX-500FI, PMX-500DBr, PMX-550B, and PMX-550DBr) were designed to be actively taken up by mitochondria, targeting harmful oxidants while potentially modulating the expression of genes involved in recycling of defective mitochondria. The desired outcome is to protect and improve the overall health of cells, particularly those that are difficult, if not impossible, to replace (particularly neurons, but also cardiac and skeletal muscle cells). At this point, our experiments have demonstrated a clear neuroprotective effect on SNpc neurons using PMX-500FI and PMX-550DBr in rotenone-treated rats; however, a clear neuromotor or behavioral improvement was difficult to discern. Our continuing efforts are focused on refinement of the model for neuromotor validation of the neuroprotective effects described here.

PMX-500FI is a novel small-molecule compound that contains both L-carnitine (LC) and α -lipoic acid (ALA) moieties. LC is used by cells to shuttle long chain fatty acids into mitochondria where they are burned for energy and also act as antioxidants. ALA is an essential cofactor in aerobic metabolism and is one of the most potent antioxidants in nature, present in a variety of foods; however, its bioavailability in the diet is limited, and both LC and ALA are cleared by the liver in the first passage (Steliou et al. 2015). Both ALA (Abdin and Sarhan, 2011; Jalali-Nadoushan and Roghani, 2013) and a therapeutic combination of LC and ALA (Zaitone et al., 2012) were shown to have beneficial effects in rodent models of PD, and are found in various formulations of the “Mito Cocktail”, a palliative treatment commonly used by patients with mitochondrial disease. We induced mitochondrial deficits using the pesticide rotenone, which is a potent and irreversible inhibitor of mitochondrial CI (Betarbet et al., 2000; Sherer et al., 2003). Rotenone

exposure has been shown to result in decreased adenosine triphosphate (ATP) production and a buildup of reactive oxygen and nitrogen compounds, resulting in oxidative damage to mitochondrial DNA (mtDNA) and mitochondrial proteins and membranes (Tsang and Chung, 2009).

It was reported by our lab that rotenone-mediated activation (via phosphorylation) of stress-activated protein kinase/Jun-amino-terminal kinase (SAPK/JNK) was attenuated by PMX-500FI co-treatment in mice (Parameshwaran et al., 2012). ROS generation was reduced in midbrain and forebrain, and PMX-500FI also protected against rotenone-induced neuromotor decline (Parameshwaran et al., 2012). In a more recent study, PMX-500FI co-treatment improved synaptic function in mice that were given rotenone and long term potentiation (LTP), a proxy for neural plasticity and memory formation, was maintained (Parameshwaran et al., 2015). In addition, PMX-500FI was also shown to rescue rotenone-induced activation of stress-related protein pERK1/2, while increasing phosphorylation of BAD and decreasing BAX translocation to mitochondria, both of which are antiapoptotic (Parameshwaran et al., 2015).

In the present study, we report *in vivo* neuroprotection with PMX-500FI and PMX-550DBr in the treatment of mitochondrial dysfunction in a rat model of PD. Butyrylcarnitines PMX-550B and PMX-550DBr were designed to take advantage of the histone deacetylase activity of butyrate (Davie, 2003; Dokmanovic et al., 2007), which was shown to stimulate neuroprotective cellular pathways in response to oxidative damage (Gardian et al., 2004; Steliou et al., 2015; Volmar and Wahlestedt, 2015); and has shown promise in treating a variety of neuropathologies including certain types of cancer (Chou et al., 2011). Preliminary data from our laboratory suggested

enhanced neuroprotective activity for PMX-550DBr compared to PMX-550B and we have continued to investigate this finding.

In our modeling of mitochondrial dysfunction in rats, daily injections of rotenone for 14 days produced neuromotor symptoms in the rat that are similar to human PD (Cannon et al., 2009) and resulted in degeneration of tyrosine hydroxylase immunoreactive (THir) dopaminergic neurons of the SNpc. Rotenone treatment depresses mitochondrial energy output (reduced production of ATP) in cells with a concomitant increase in production of harmful ROS. Separate groups of rotenone-treated rats were co-treated daily with PMX compounds, while others were treated with a combination of ALA and LC (Zaitone et al., 2012). After completion of the treatment phase of these experiments, we performed a variety of tests to assess the rotenone-induced phenotype and to determine if PMX co-treatment had a beneficial effect on neuromotor parameters. Following testing, post-mortem samples were collected for IHC analyses of brain and immunoblotting analyses of proteins involved in oxidative stress, apoptosis and mitophagy (Novak, 2012). Immunoblotting analyses are ongoing and will be the subject of an additional, separate study.

METHODS

Treatment compounds

Rotenone (MP Biomedicals) (Figure 1) stock solution was formulated by dissolving rotenone in DMSO (100mg/ml), which was then aliquoted and stored at 4°C until needed. Directly prior to use, aliquots were removed from cold storage and allowed to warm to ambient temperature. A caprylic/capric triglyceride vehicle, Neobee (Spectrum Chemical Mfg., Inc.), which functions as a time-release vehicle, was added to rotenone aliquots at a specified volume to bring the rotenone mixture to final dosing concentration per experimental protocol. This mixture was vortexed immediately prior to each injection to guarantee a thorough emulsification of components. Following daily injections, any excess rotenone/vehicle mixture was discarded. Stock solution was refreshed twice weekly to ensure rotenone potency was maintained.

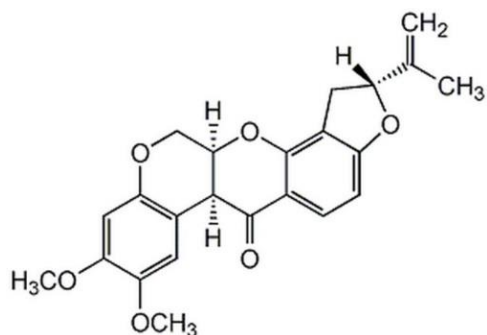

Figure 1. Chemical structure of Rotenone.

Synthetic carnitinoid compounds (Figure 2): PMX-500FI, PMX-500DBr, PMX-550B, PMX-550DBr, or a mixture of ALA plus LC, were all provided by PhenoMatriX, Inc., Boston, MA. Compounds were dissolved in dimethyl sulfoxide (DMSO), or phosphate buffered saline (PBS, pH 7.2) for L-carnitine, at equimolar concentrations to formulate stock solution, aliquoted, and stored at 4°C. Directly prior to use, aliquots were removed from cold storage and allowed to warm to ambient temperature. Neobee vehicle was added to aliquots at a specified volume to bring the mixture to final dosing concentration per experimental protocol. This mixture was vortexed immediately prior to each injection to guarantee a thorough emulsification of components. Following daily injections, any excess PMX/vehicle mixture was discarded.

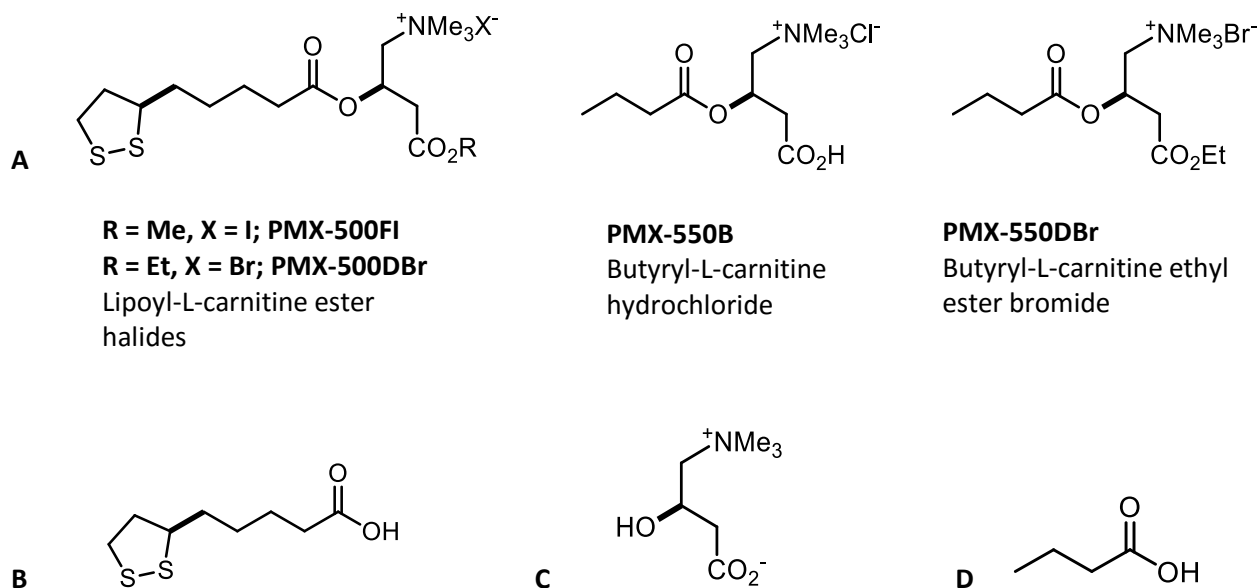

Figure 2. Chemical structures of PMX compounds (A), *R*-(+)-lipoic acid (B), L-carnitine (C), and *n*-butyric acid (D).

Animals

All procedures, including housing, neuromotor testing and euthanasia, conformed to Institutional Animal Care and Use Committee (IACUC) guidelines and the Guide for the Care and Use of Laboratory Animals, under Office for Laboratory Welfare (OLAW) assurance #A3152-01.

Rotenone rat model

Lewis rats, 9-10 weeks old, were procured from Envigo (formerly Harlan) and cared for in accordance with IACUC guidelines. Animals were given a one week period for acclimation to the facility and to learn to relax in a single-handed, dorsal recumbent restraint. Rat tails were marked with black marker to identify individual animals, and body weights were taken daily for accurate dose calculation. To induce the Parkinson-like phenotype, rotenone was administered via daily intraperitoneal (IP) injections for the course of the experiment, concurrently with experimental PMX-compounds that were being evaluated. Animals were observed directly following injections to ensure they remained mobile and able to access food and water. At the end of the treatment period rats were evaluated using a battery of neuromotor tests, and then humanely euthanized and necropsied.

Transgenic mouse model

A breeding pair of 6 week old, *Park2*^{tm1SHn} mice (*PARK2*) were procured from Jackson Lab (Bar Harbor, ME, USA) and mated upon arrival. These mice carry a homozygous mutation (premature stop codon in the 3rd exon of the *PARK2* gene) that results in production of a truncated form of the parkin protein. Mice were bred in-house to fulfill appropriate age and

gender matched cohorts for experiments. No additional acclimation was necessary for mouse cohorts. To develop a Parkinson-like phenotype in *PARK2* mice, rotenone was administered in the same manner as rat cohorts, mice were then evaluated with neuromotor testing, and humanely euthanized and necropsied.

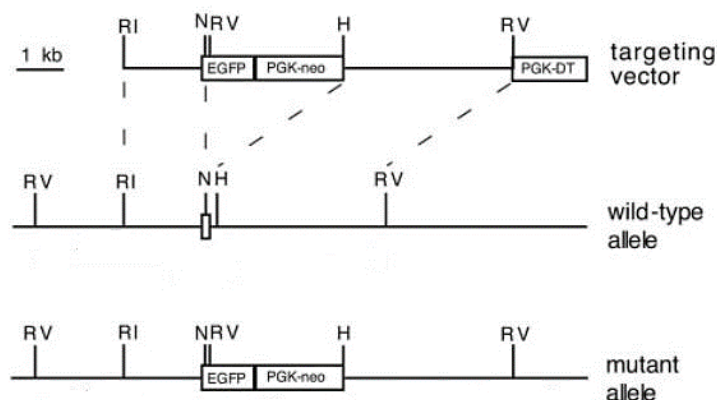

Figure 3. Generation of *PARK2* mice. A schematic representation of the wild-type parkin genomic region encompassing exon 3, indicated by a small open box, and the targeted allele.

Abbreviations: H, HindIII; N, NdeI; RI, EcoRI; RV, EcoRV (Goldberg et al., 2003).

Experimental protocols

Rat Experiment I

Beginning on day one of the experiment rats were given daily IP injections of one of the synthetic carnitinoid compounds: PMX-500FI (10.0mg/kg), PMX-500DBr (10.7mg/kg), PMX-550B (5.5mg/kg), PMX-550DBr (6.9mg/kg), or a mixture of ALA (4.2mg/kg) plus LC (3.3mg/kg). Pilot studies in our lab had determined optimal concentration of PMX-500FI to be 10.0 mg/ml for *in vivo* administration; concentrations of additional PMX compounds, and ALA plus LC mixture,

were based on equimolar concentrations to PMX-500FI concentration. A second IP injection, administered one hour later, contained rotenone solution at a concentration of 2.5mg/kg body weight. Matching negative control animals received sham doses (DMSO and vehicle only) for both injections, and positive controls (rotenone model induced, but no therapeutic test treatment) were given sham followed by the rotenone injection. Five cohorts were run to evaluate the four PMX compounds and the LC/ALA mixture. Each cohort (n=12) contained three sham/sham dosed rats (control group), three sham/rotenone rats (rotenone only group), and six treatment/rotenone rats (treatment group). IP injections continued until d17, with neuromotor tests being performed on d15 (open field test) and d17 (Rotarod test). On d18 rats were necropsied in two groups, with samples being designated for either protein assays (n=6) or immunohistochemistry (n=6).

Group	IP Injection #1	IP Injection #2	n=
Control	Sham	Sham	3
Rothenone Only	Sham	Rothenone	3
Treatment	PMX compound	Rothenone	6

Table 1: Study groups for rat experiment I.

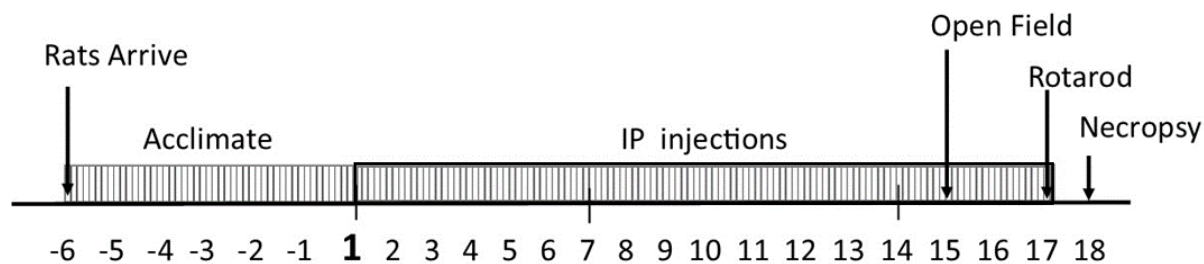

Figure 4: Schematic of timeline for rat experiment I.

Rat Experiment II

Cohorts were structured as previously described with control (n=4), rotenone only (n=4), and treatment (n=8) groups. Rats were pre-trained for the Rotarod test during the acclimation period (d -5 to d -3), then dosed similar to previous experiment but with an increase of rotenone dosage to 3.0mg/kg, for two weeks (d1 to d14). Animals were then allowed a 7 day rest period during which no injections were given (d15 to d21). Neuromotor testing was performed on d22 (OFT and grip test), d23 (balance beam test) and d24 (Rotarod test) and they were necropsied on d25 with samples designated for protein assays (n=8) or immunohistochemistry (n=8).

Group	IP Injection #1	IP Injection #2	n=
Control	Sham	Sham	4
Rotenone Only	Sham	Rotenone	4
Treatment	PMX compound	Rotenone	8

Table 2. Study groups for rat experiment II

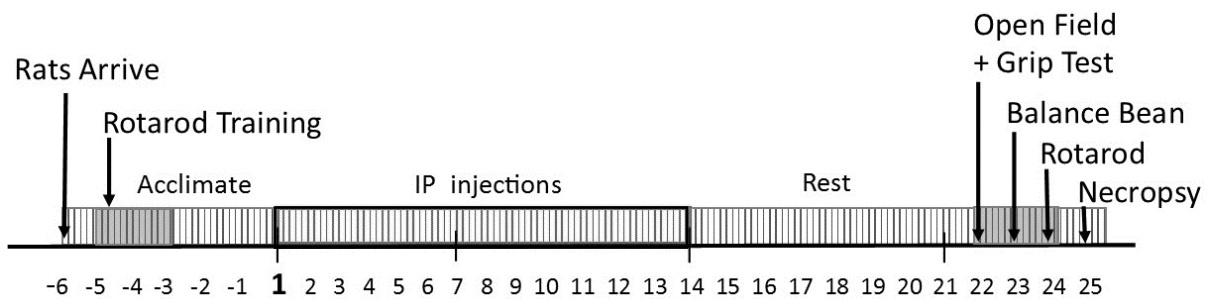

Figure 5. Schematic of timeline for rat experiment II

Transgenic Mouse Pilot I: Metabolic Cage Study

The Auburn University Metabolic Phenotyping Laboratory (AUMPL) Promethion™ Metabolic and Behavioral Phenotyping System (Sable Systems, Inc.) was utilized for mouse activity analysis. This system can monitor and provide data for 8 singly-housed mice concurrently requiring us to run 3 groups (n=23). Three-four month old *PARK2* mice (7 females and 4 males) along with matched wild type C57BL/6 (Jackson Labs, Bar Harbor, ME) controls (8 females and 4 males) were housed in individual metabolic cages and monitored for 72 hours. Following the monitoring period mice were returned to their home cages, and data compiled was analyzed by the system software for the middle 48 hours, capturing two undisturbed light/dark cycles. Raw data for an assortment of animal metabolic and activity related variables was obtained from each run and pooled for further analysis.

Transgenic Mouse Pilot II: Rotenone Dosing

PARK2 mice were bred in-house, aged to 5-6 months old, ear-punched for individual animal identification and body weights were measured daily for dose calculations. Beginning on day one of the experiment, daily IP injections of rotenone were administered to animal groups in increasing concentrations (2.0-3.5mg/kg), with the control group receiving a sham dose, and continued until necropsy. Neuromotor assessment of mice was performed on d7 and d14 (wire hang test), and d28 (open field test), d29 (Y-maze test), d30 (Rotarod test). Animals were euthanized for tissue collection following completion of neuromotor assessment.

Transgenic Mouse Experiment

PARK2 mice were bred in house, aged to 6-7 months old, ear-punched for individual animal identification and body weights were measured twice weekly for dose calculations. Beginning on d1 of the experiment, daily IP injections of PMX-500FI (10mg/kg) and rotenone (4mg/kg) were administered using the same procedure described for rat experiments. Injections continued until d14, then neuromotor assessment of mice was performed on d15 (open field test and grip test), d16 (balance beam test), and d17 (wire hang test). Animals were necropsied following completion of assessment and tissues collected for protein assays (n=10) and immunohistochemistry (n=10).

	Control	Rotenone Only	Rotenone + PMX-500FI	Total
Female	4	4	3	11
Male	3	3	3	9
Total	7	7	6	8

Table 3. Study groups for transgenic mouse experiment.

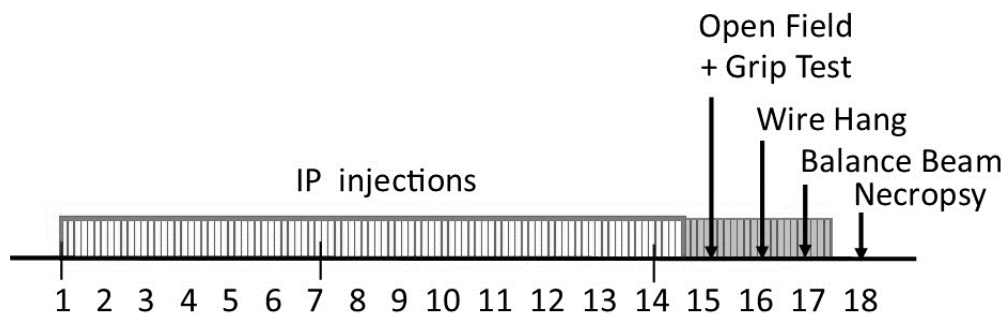

Figure 6. Schematic of timeline for transgenic mouse experiment.

Neuromotor Assessment

Following the specified course of treatment, rodents were subjected to a battery of neuromotor testing over 3 days. Each test was conducted at the same time of day to reduce variability among cohorts, and performed sequentially, least stressful to most stressful.

Open Field Test

The open field test (OFT) is a quantitative measure of general locomotor activity. For this test rodents are placed in the center of an empty clear acrylic box and allowed to explore: 100cm x 100cm box and 10 minute duration for rats, or 50cm x 50cm box and 5 minute duration for mice. Each session was video recorded by a camera aligned overhead and animal movement was tracked using SMART3.0 software (Panlab, Harvard Apparatus) Total distance traveled, percent time spent resting vs. moving, and mean speed were among the variables later analyzed. At completion of the specified time limit the rodent was returned to its home cage and the apparatus was wiped down with 70% ethanol, preparing it for the next animal. The OFT is a novel exposure and only one trial is performed for each animal. After all rodents in a cohort have been tested the full dataset is compiled by the SMART3.0 software. Following completion, video footage is later reviewed and each rat scored for the number 'rears'. A rear is counted as the rodent sitting back on its hind feet, raising both forefeet off the floor above midline, and can be either free standing in the center of the field or against the wall of the enclosure. Both forefeet must return to the floor for the rear to be considered complete, and before additional rears can be counted.

Grip Test

Grip strength was tested using a force gauge (model DFG55-5; Omega Engineering, Inc., Stamford, CT, USA) equipped with a four paw grid (eb Instruments, Pinellas Park, FL, USA). Rodents were held by the base of the tail and lowered onto the grid and allowed to grip with all four paws. A steady, consistent (as much as possible) lateral force, in line with the grid of the force gauge, was applied until the animal released its grip on the grid. In each trial, three attempts were conducted and the maximum of the three was used as a measurement of maximum grip strength.

Balance Beam Test

To test balance and coordination rodents were trained to cross a wooden balance beam elevated ~3 feet off the floor. The starting end of the beam-apparatus is an open platform with a light attached shining towards the beam, and it finishes with a darkened box at the terminus of the beam. The beam itself is a wooden dowel and can be of various shapes and sizes changing the sensitivity of the test; for these experiments a 1.5" square dowel and a 1.5" round dowel were used. Initial training of animals was performed using the square beam, placing the rodent on the center of the beam with their head facing the end point. Most rodents readily moved away from the light and into the box; those that stalled were tapped on the hind end to encourage forward movement towards the box, and any that turned around were immediately righted and encouraged to move towards the box. Once inside the finish box the animals were allowed 30 seconds of rest, then placed at the start of the beam and allowed to cross. If the rodent crossed directly and without stopping it was considered adequately trained; if not,

additional training as described above was provided until the animal crossed directly. We found that most rodents learned to cross the beam quickly and did not require additional training. Following training each rat was placed on the balance beam six times, 3 crossings with the square beam then after a 30 minute break 3 crossings with the round beam. Each trial was video recorded, with the field of view directly down the beam lengthwise, allowing for a clear view of hind foot falls. Each of these videos was later reviewed and scored for foot slips- or the number of times the animal's foot slipped off the balance beam. After tallying of all foot slips was completed, averages were compared for square beam, round beam, and total beam foot slips.

Y-Maze Test

The rodent is placed in one end of the Y-maze (custom fabricated) and allowed to explore two arms of the maze for five minutes; the third arm is not accessible. Animals are given a 1 hour break, then reintroduced to the Y-maze for another 5 minutes at the same starting point with all 3 arms available for exploration. The rodents are scored on whether they enter the familiar or the novel arm first, and how many times they visit the novel arm.

Pole Test

A measure of locomotor activity, the pole test consists of a pole (2.5cm in diameter x 100cm in height), wrapped in vet wrap to create a rough surface, and mounted to a steady base perpendicular to the floor. Rodents are placed at the top end of a rough surfaced pole which is perpendicular to the floor. The rodent is placed on the top of the pole with its head facing upward and in a timed trial is expected to turn around and climb down the pole. The time required for

the rodent to descend to the floor was recorded for each trial with a cut off of 240 seconds. Three trials were run and the results were averaged; animals were given a 30 minute rest between trials.

Wire Hang Test

Motor coordination and muscular strength were tested using the wire hang test. Rodents are placed on a standard size wire-bar cage top allowing all four feet to grip, then the wire top is inverted and suspended 3 feet above a padded box. Animals are timed as they hang upside-down and cling to the wire grid until they fall; latency to fall is recorded for each with a cut off of 240 seconds. Three trials were run and the results were averaged; animals were given a 30 minute rest between trials.

Rotarod Test

Motor coordination and balance were tested using a Rotarod (Rotamex, Columbus Instruments, Columbus, OH, USA). Prior to data collection trials, rodents are trained to balance on the Rotarod. We used two variations of this training: (1) Animals were introduced to the Rotarod apparatus the day prior to testing with a series of short sessions throughout the day. First rodents are taught to balance on the stationary rod. Once they are able to balance for 30 seconds, rod rotation is introduced at a speed of 1 rotation per minute (rpm), slowly increasing to 4 rpm, and maintaining there until the rodent is able to balance for 30 seconds at this speed. In subsequent training sessions rotation is incrementally increased until a maximum speed of 10 rpm is attained. Throughout the training, animals are discouraged from turning around or

climbing up the sides of the Rotarod and are immediately replaced in the corrected position if they do so. (2) Animals are introduced to the Rotarod as described above, but training occurs during the acclimation period prior to experiment start and is conducted in 12 sessions spread over 3 days (4 sessions/day). After being trained to balance on the rotating rod, trials are performed introducing acceleration. The Rotarod is programmed to begin at 4 rpm and increase by 1 rpm every 8 seconds until a maximum speed of 40 rpm is reached. Rodents are placed on the stationary rod and the program started; latency to fall is recorded by the Rotarod apparatus. Three trials were run with the results averaged; animals were given a 30 minute rest period between trials.

Necropsy

Perfusion

Rodents used for IHC analysis of brain were anesthetized with a combination of ketamine (100mg/kg) and xylazine (20mg/kg). Fixation was accomplished by transcardial perfusion with 4% paraformaldehyde in PBS. Whole fixed brains were removed and stored in fixative at 4⁰C for two days, followed by 30% sucrose with daily changes for 3-4 days before sectioning.

Tissue collection

Rodents used for protein assays were humanely euthanized, dissected, and tissue from the liver, heart, gastrocnemius muscle, and brain were removed, snap frozen in liquid nitrogen, and stored at -80°C.

Immunohistochemistry

This service was performed by the Foradori Lab - Rats were perfused with PBS followed by 4% paraformaldehyde in PBS. After overnight (16-18 hrs) fixation in 4% paraformaldehyde at 4°C, brains were infiltrated with 30% sucrose (3-4 changes). Coronal brain slices (30µm thickness) were prepared using a cryostat. Immunohistochemistry (IHC) procedures were carried out on every fourth free-floating section at room temperature. Sections were washed in PBS for several hours to remove the 30% sucrose cryoprotectant. After washing, the sections were incubated in PBS containing 3% normal goat serum (ICN-Biochemical, Costa Mesa, CA) and 0.1% Triton X-100 (PBSTX, Sigma-Aldrich, Inc., St. Louis, MO) for 1 hr. Sections were then incubated in rabbit polyclonal antibody against Tyrosine Hydroxylase (1:1000; AB152 Millipore) in PBSTX for 2 days at 4°C. Following incubation, sections were washed extensively in PBSTX and then placed in a solution of PBSTX with biotinylated goat anti-rabbit IgG (1:1000; Jackson Laboratories) for 1 hr. After incubation the sections were washed and then incubated in PBSTX containing Vectastain Elite™ ABC HRP (1:1000; Vector Laboratories) for 1 hr. After rinsing in PBS, sections were incubated in PBS with 0.05% 3,3'-Diaminobenzidine and 0.015% H₂O₂ in PBS for 10 mins. Sections were rinsed in 0.1 M phosphate buffer and mounted on positively charged glass slides and allowed to dry. Slides were dehydrated in ethanol and coverslipped with Permount™ (Electron Microscope Sciences, 100496-552). Controls included omission of the primary antibodies from the immunostaining protocol, the absence of which completely eliminated staining for the corresponding antigen. TH immunoreactive (TH-ir) cells were counted unilaterally in four consecutive sections of the dorsal tier of substantia nigra *pars compacta* (SNpc-A9d) by a blinded

observer. Whole-section mosaics of high-magnification images were taken using a Nikon Elements 5.1.

Statistical Analysis

All statistical analysis was performed using R-studio software with the '*asbio*' package. Mouse gender performance was analyzed using Student's t-test. All other data were analyzed with one-way ANOVA with Tukey HSD post hoc test. Statistical significance was accepted at $p < 0.05$.

RESULTS

Rat Experiment I

Rats in the control group continued to gain weight as most other rats steadily lost body weight through the course of the study. The percent body weight changes (%BW) in controls was significantly greater as compared to rats treated with rotenone and those co-treated with PMX compounds (ANOVA, $p < 0.001$). Rats co-treated with rotenone/ALA + LC saw no difference in %BW when compared to control rats, but had significant weight gain when compared to other groups (ANOVA, $p < 0.01$)

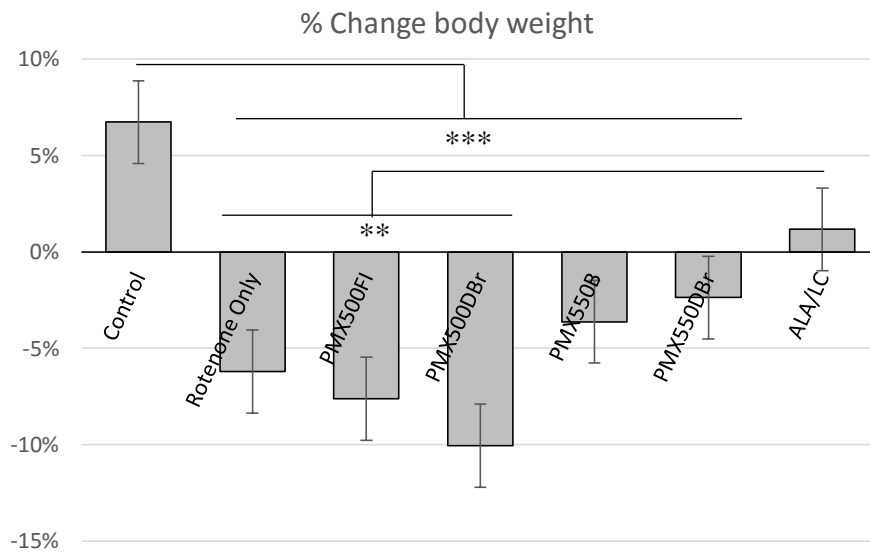
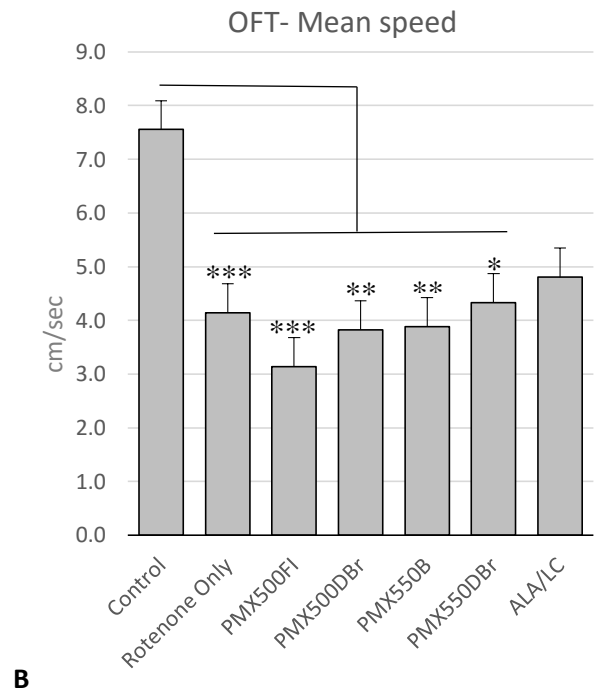
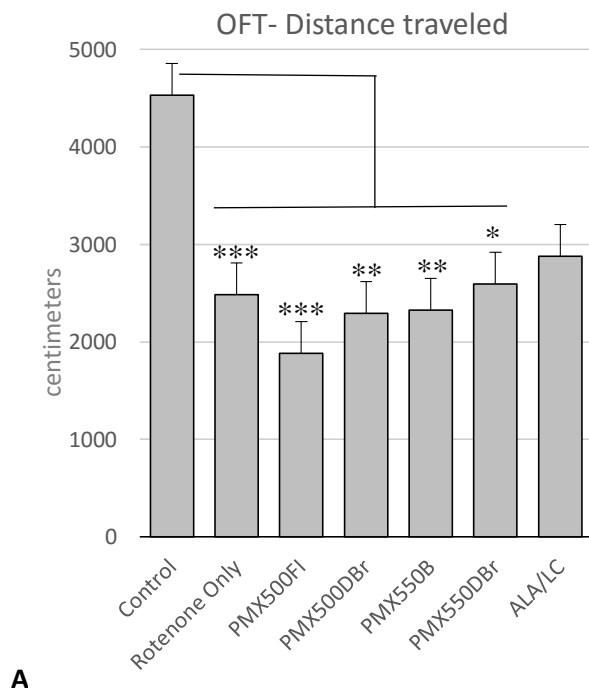
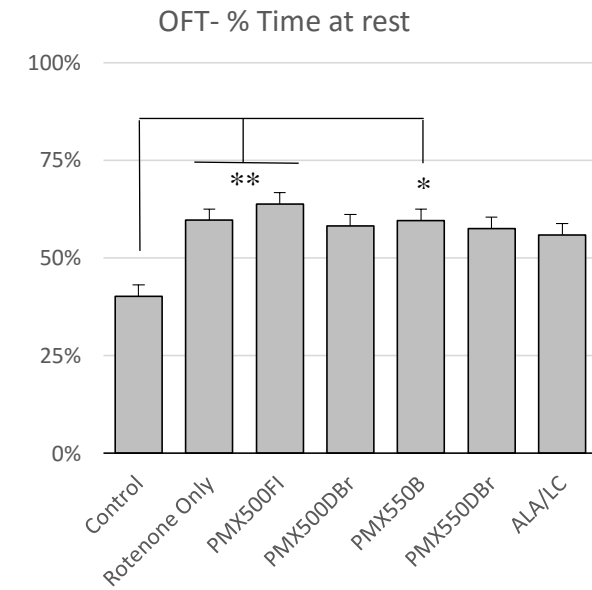

Figure 7. Control rats continued to gain weight through out the study, ending with significantly higher %BW than rats given rotenone and those co-treated with PMX. Rats receiving co-treatment with ALA/LC also maintained significantly higher %BW than those treated with only rotenone as well as co-treated PMX-500FI and PMX-500DBr. ** $p < 0.01$ and *** $p < 0.001$

When locomotor activity was measured using the OFT we found control rats performed significantly better than rotenone (only) rats in all measured variables- having a greater total distance traveled, faster mean speed, less time spent resting, and more time moving fast (ANOVA, $p < 0.01$ for all), and displayed more rearing behavior (ANOVA, $p < 0.05$). Rats receiving co-treatment with PMX compounds or ALA/LC did not have an improved performance in any of these variables over rats receiving rotenone only. Using the Rotarod test we found no difference with latency to fall among any of the groups ($p > 0.05$).





C

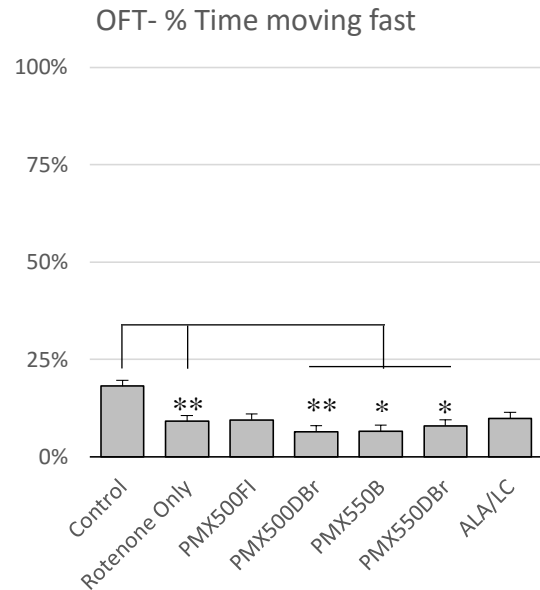

D

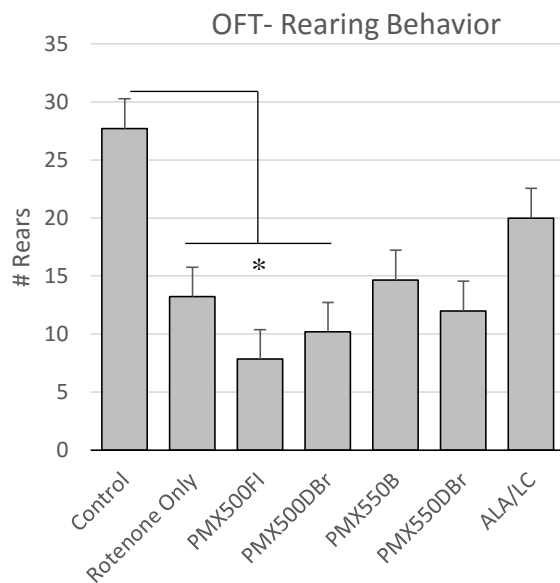

E

Figure 8. Control rats performed significantly better in all measured variables of the OFT than rats treated with Rotenone (A-E). Co-treatment with PMX compounds or ALA/LC did not significantly improve performance for any OFT variable. * $p < 0.05$, ** $p < 0.01$, *** $p < 0.001$

Immunohistochemistry of brain samples revealed decreased tyrosine hydroxylase (TH) labeling of neurons in the SNpc in rotenone treated rats (Figure 9). Additionally, IHC showed PMX compounds provided a significant neuroprotective effect and co-treatment with PMX-500FI and PMX-550DBr (Figure 10) protected rats from loss of TH-positive neurons in the SNpc ($p < 0.05$)

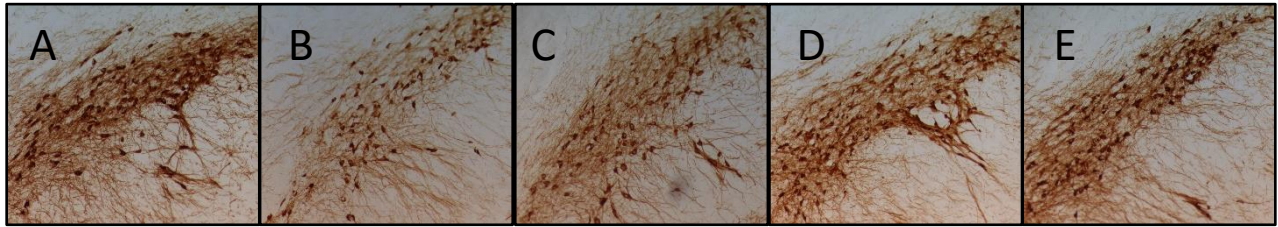

Figure 9. Immunohistochemistry of rat brain SNpc labeled with a primary antibody specific for tyrosine hydroxylase. Quantitation of TH-positive neurons is shown in Figure 10. Control untreated (A), Rotenone only treated (B), Rotenone co-treated with ALA+LC (C), Rotenone co-treated with PMX-500FI (D), Rotenone co-treated with PMX-550DBR (E). See methods for details.

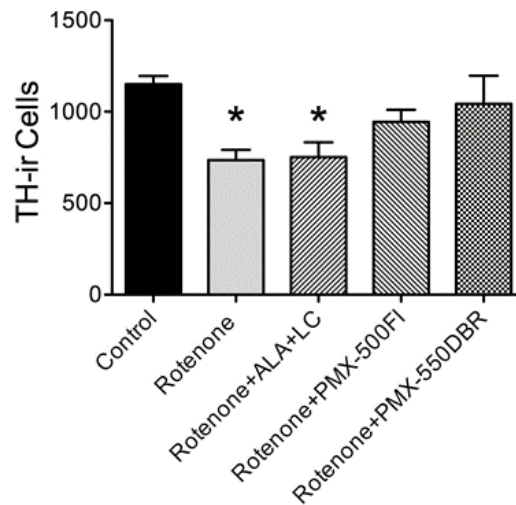

Figure 10. Quantitation of TH-positive neurons pictured in Figure 9. Untreated controls and rats co-treated with PMX-500FI and PMX-550DBr had significantly more TH positive neurons than those receiving treatment with only rotenone or co-treated with rotenone and ALA+LC. All are n=3 except for rotenone, which is n=4, *p<0.05.

Rat Experiment II

During the injection period rats in the control group gained weight and all rats given rotenone steadily lost body weight, as seen in the previous experiment, but the 7 day rest period afforded an opportunity for rapid weight gain for rats that had lost weight. Final body weight analysis found that control rats had a significantly higher %BW change than those treated with rotenone (only) and co-treated with PMX-500FI (ANOVA, $p < 0.001$). Rats co-treated with other PMX compounds saw no difference in %BW change. When locomotor activity was measured using the OFT following the 7 day rest period we found control rats performed significantly better than PMX-500FI rats in all measured variables- having a greater total distance traveled (ANOVA, $p = 0.0096$), faster mean speed (ANOVA, $p = 0.0095$), spent less time resting (ANOVA, $p = 0.0035$) and more time moving fast (ANOVA, $p = 0.0058$). Rats receiving only rotenone and those given other PMX compounds had no difference in OFT performance. Addition of new neuromotor tests, grip test and balance beam test, found no difference in grip strength or number of foot slips between groups and, despite providing increased Rotarod training, we found no difference with latency to fall between any of the groups with Rotarod testing ($p > 0.05$). IHC analysis of rat brains found no difference in TH labeling of SNpc ($p > 0.05$).

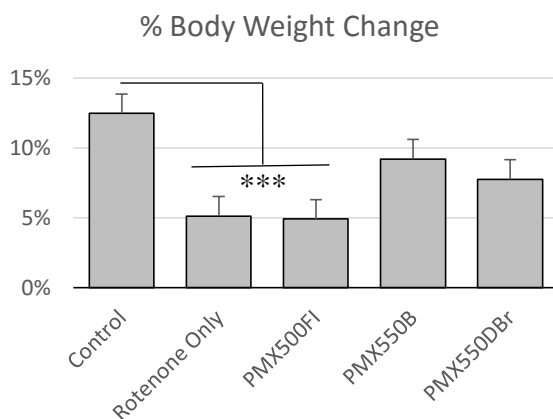

Figure 11. Control rats had a significantly higher %BW change than those treated with rotenone (only) and rats co-treated with rotenone and PMX-500FI. *** $p < 0.001$

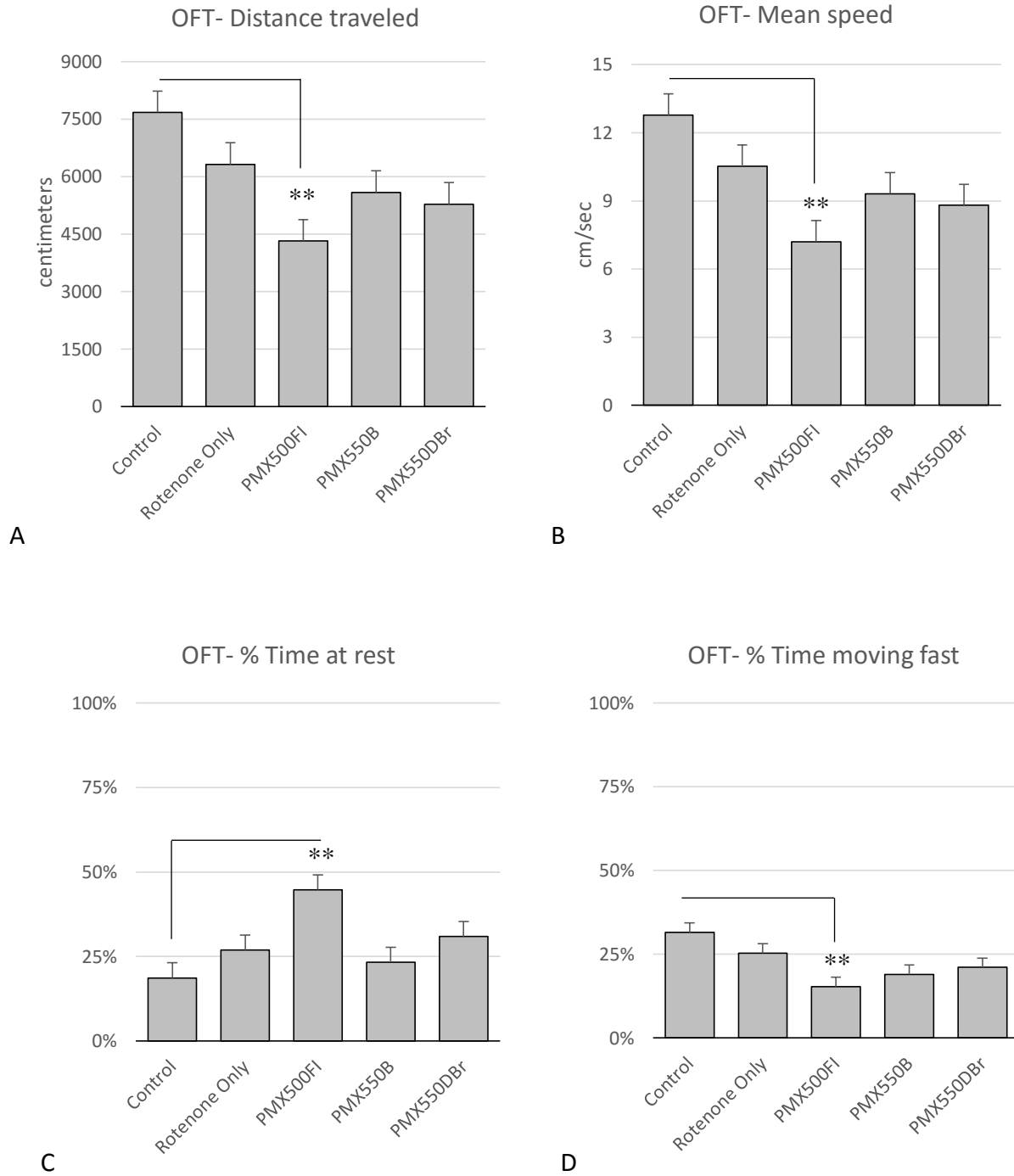

Figure 12. OFT results were similar between all animals except those co-treated with PMX-500FI. These rats performed significantly worse than untreated controls; traveling shorter distance (A) at a slower speed (B) and spending a greater percent of time resting (C) and a lesser percent moving fast (D). **p<0.01

Transgenic Mouse Pilot I

No differences were found between wild type C57BL6 mice and transgenic *PARK2* mice in any of the variables measured by Promethion™ system including total energy expenditure, distance traveled, average speed, or % time sleeping ($p>0.05$ for all).

Transgenic Mouse Pilot II

No differences were found between control mice and rotenone dosing groups 2.0, 2.5, 3.0, or 3.5mg/kg in any of the neuromotor tests conducted: OFT, Y-maze, wire hang, or Rotarod ($p>0.05$).

Transgenic Mouse Experiment

Mice co-treated with PMX-500FI performed better on the balance beam test, having significantly fewer foot slips on the square rod than mice receiving only rotenone (ANOVA, $p=0.0228$). However, no differences were found between groups with OFT, grip test, wire hang test, or %BW change.

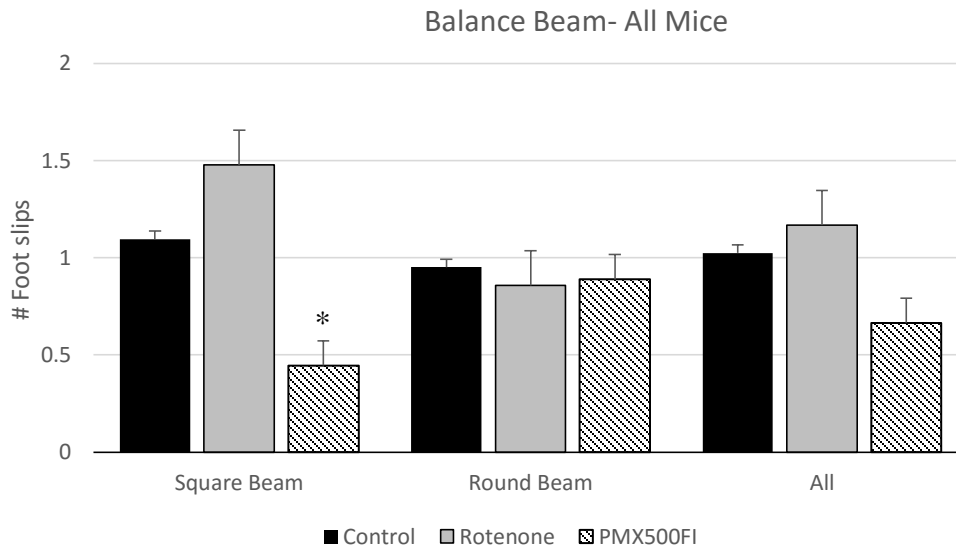

Figure 13. Mice co-treated with rotenone and PMX-500FI performed better than other animals on the square balance beam (3 trials) with significantly fewer hind foot slips. However, when tested with the round balance beam (3 trials) no difference was found among groups for the number of hind foot slips, or when all trials from both balance beams (6 trials) were analyzed together. *p<0.05

When gender was considered there was a %BW change difference between the sexes with male mice losing significantly more weight than females (t-test, p=0.009). Neuromotor assessments showed female mice outperformed male mice in all OFT parameters traveling further (t-test, p=0.0097), spending less time resting (t-test, p=0.0134), and rearing more (t-test, p=0.0073), as well all having a longer latency to fall with the wire hang test (t-test, p=0.0057). There were no differences between male and female mice when evaluated with the grip test or balance beam test.

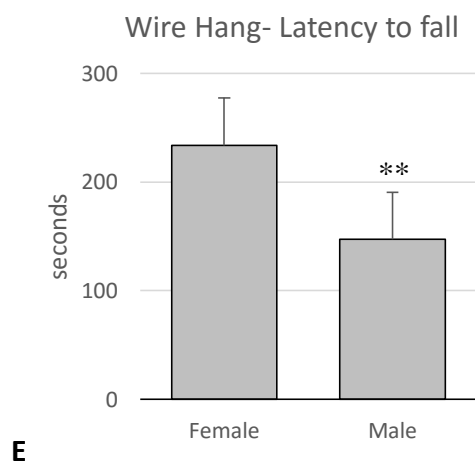
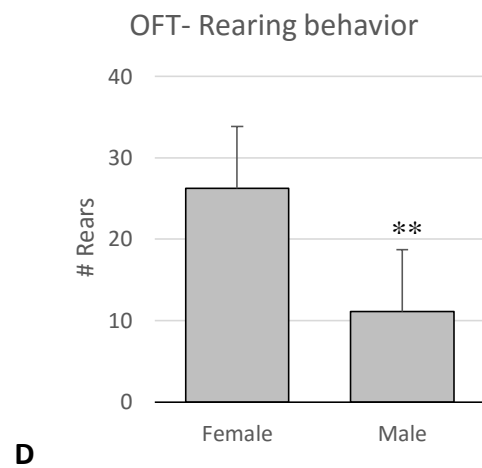
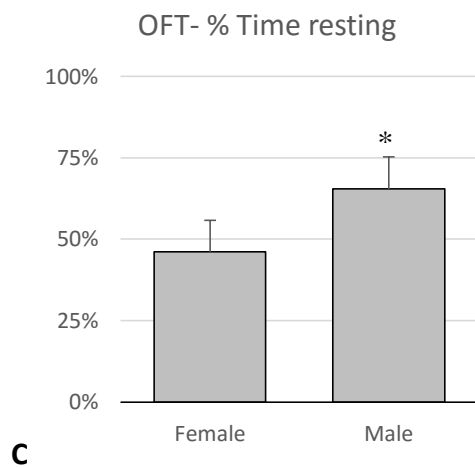
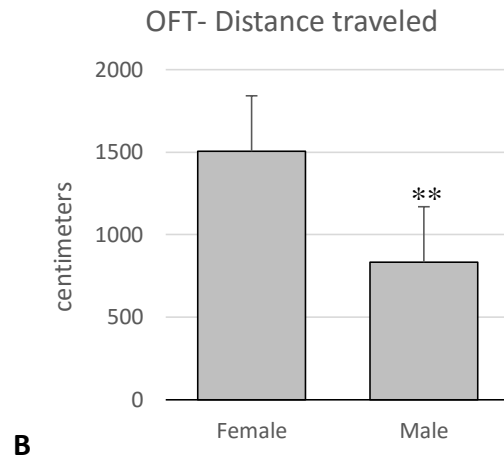
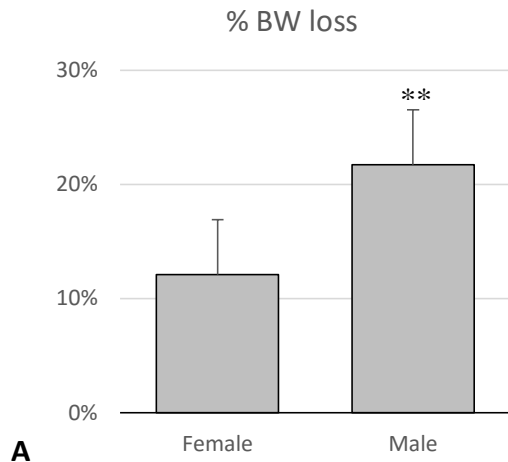

Figure 14. When compared to females, male *PARK2* mice lost significantly more body weight (A) during the study, were significantly less active in the OFT- traveling less distance (B), resting more (C), rearing less (D), and fell off the wire hang test significantly faster (E).

* $p < 0.05$ and ** $p < 0.01$

When female mice were analyzed separately from male mice we found that female mice co-treated with PMX-500FI performed better in the balance beam test, having significantly less foot slips (ANOVA, $p=0.0017$), but no differences were found in performance of other neuromotor tests. Male mice, however, saw no difference in neuromotor performance with PMX-500FI when analyzed separately from females. Additionally, IHC analysis of mouse brains found no difference in TH labeling of SNpc.

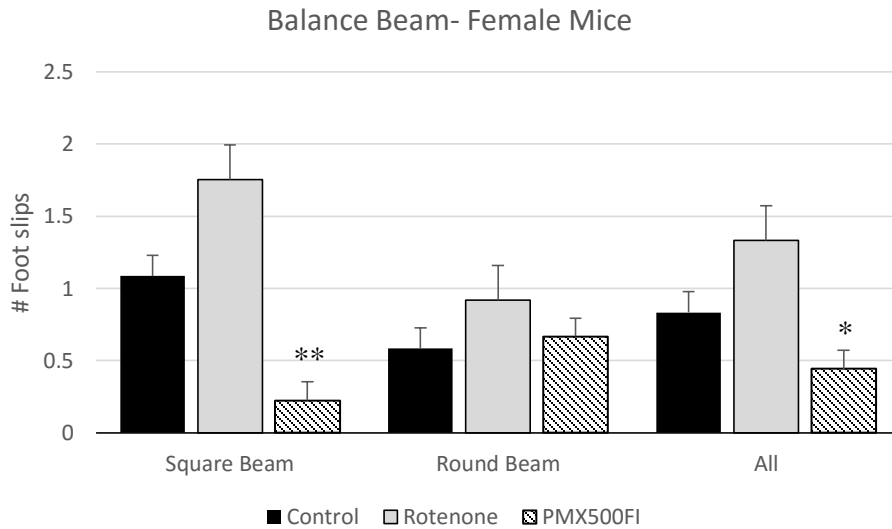

Figure 15. Female mice co-treated with rotenone and PMX-500FI performed better than other animals on the square balance beam (3 trials) with significantly fewer hind foot slips. However, when tested with the round balance beam (3 trials) no difference was found between groups for the number of hind foot slips. When all trials from both balance beam shapes were analyzed together (6 trials) a significant improvement was found for PMX-500FI co-treated mice. * $p<0.05$, ** $p<0.01$

DISCUSSION

Rotenone-induced CI inhibition in Lewis rats is a well-established animal model of PD (Allen et al., 2009; Betarbet et al., 2000; Cannon et al., 2009; Panov et al., 2005; Sherer et al., 2003); however, most studies to date used very narrowly defined, single-method measures for assessing neuromotor impairment. In this study, we sought to develop a treatment regimen that produced a less debilitating phenotype that would allow for more subtle and more diverse assessment of neuromotor function, and would thus lend itself to more informative preclinical evaluation of potential therapeutic compounds, such as the PMX compounds investigated in this study. With our refined rotenone-rat protocol we were able to discern a disease phenotype, but we saw variability in the severity of the effect. As it was our aim to correlate measurable neuromotor performance to pathological changes in the SNpc it was important that the induced phenotype not debilitate the animals to the extent that they were unable perform the task. This milder phenotype, though discernable to the observer, proved difficult to assay.

Immunohistochemistry of brain samples revealed decreased TH labeling for dopaminergic neurons in the SNpc in rotenone treated rats from our first experiment and confirmed that our rotenone dosing scheme was sufficient to cause pathological changes in Lewis rats. Additionally, IHC showed that PMX compounds provided a neuroprotective effect and co-treatment with PMX-500FI and PMX-550DBr protected rats from loss of TH-ir neurons in the SNpc. Through neuromotor testing we were able to quantify a distinct phenotype using the open field test,

finding that rotenone treated rats were significantly less active and spent more time resting than their control counterparts ($p < 0.05$). These animals also steadily lost body weight throughout the course of this study, whereas control groups gained significant body weight during the same period. However, co-treatment with PMX compounds did not improve the performance of rats, though animals co-treated with a combination of ALA and LC did show improved weight gain compared to those treated with PMX compounds. Interestingly, despite decreased locomotor activity in the OFT, rotenone treated rats performed as well as control animals when assayed with the Rotarod test. The reason for this is unclear, but we speculated that Rotarod training received the day prior to testing may not have been sufficient for the rats to appropriately learn to perform the task, and thus may have contributed to all rats equally underperforming.

For the next experiment we sought to refine our methods of neuromotor assessment by increasing our pre-assessment training on the Rotarod test to three consecutive training days during the animal acclimation period. We also included the grip strength test and balance beam tests to the neuromotor evaluation as an additional measure to capture the subtle phenotype. Another factor we considered was whether the acute effect of rotenone systemic toxicity was overshadowing the long term neuroprotection provided by PMX co-treatment. To help answer this question the study design was altered to include a seven day rest period between the two week rotenone treatment period and neuromotor testing. Damage to neurons is permanent -- therefore by allowing rats to recover from systemic effects of rotenone, a disease phenotype that is directly linked to the neuronal damage may be more discernable and neuromotor improvement would be quantifiable in animals co-treated with PMX compounds. Recovery was observed during the 7 day rest period in all rotenone treated animals; however, no neuromotor

phenotype was discernable with any of the tests conducted. Unexpectedly, rats co-treated with PMX-500FI underperformed in the OFT, the reason for which is still unclear. It is also possible that rotenone treatment for 14 days may not be long enough to cause a measurable neuromotor deficit or that the animal is able to compensate for the neuronal damage accumulated. IHC analysis of rat brains did not show the neuroprotection we had predicted based on prior experiments as TH-positive labeling of SNpc saw no difference between treatment groups. The cause is unclear and further experiments with the rotenone-rat model and PMX compounds are necessary to gain a better understanding of these results.

We continued our modelling of CI dysfunction in transgenic *PARK2* mice, genetically engineered to produce a truncated form of the parkin protein. Parkin, the protein product of the *PARK2* gene, plays an important role in recycling of functionally defective, depolarized mitochondria via the process of mitophagy (Novak, 2012). This process is initiated by ubiquitination of PTEN-induced putative kinase 1 (PINK1) on the external surface of depolarized mitochondria (Narendra et al., 2010), which tags the organelle for destruction by recruitment of autophagy receptors (Lazarou et al., 2015). Interestingly, parkin null mice show an increased sensitivity to rotenone (Casarejos et al., 2006) and abnormal glial function (Solano et al., 2008), which prompted us to challenge *PARK2* mice with rotenone in an attempt to elicit a phenotype in younger animals. In addition, Fas-associated factor 1 (FAF1) has been implicated as a substrate for ubiquitination by parkin, an E3 Ligase, (Sul et al., 2013) and as an effector of apoptosis that is thought to play a key role in neurodegeneration (Betarbet et al., 2008) with an observed over-accumulation of FAF1 in parkin-deficient mice (Sul et al., 2013). This suggests an alternate pathway by which parkin deficiency might promote apoptosis in SNpc neurons. The human FAF1

gene resides on chromosome 1p32 (Kikyo et al., 1997) at the *PARK10* locus, which is associated with idiopathic late-onset PD (Hicks et al., 2002) – a finding that implicates FAF1 as a potentially critical effector of dopaminergic cell death in PD. More work on the roles parkin might play in PINK1-mediated mitophagy and FAF1-mediated apoptosis is warranted, and would help to clarify the mechanisms of parkin deficiency-mediated neuronal degeneration (Palacino et al., 2004) and overall mitochondrial dynamics (Kane et al., 2011).

Our experiments with *PARK2* mice yielded interesting results. Our initial pilot with metabolic and activity tracking found no difference in energy expenditure or behavior between wild type mice and transgenic *PARK2* mice, leading us to further challenge the transgenic mice with rotenone. Though our lab has utilized a rotenone-induced mouse model of mitochondrial dysfunction in previous work (Parameshwaran et al., 2015), deficiency of functional parkin protein would render *PARK2* mice more susceptible to rotenone (Casarejos et al., 2006), requiring piloting of a new rotenone dosing scheme, mirroring our rat-modeling. Little has been published on the *PARK2* mouse in regards to sex differences so we made use of all the mice available to us, both male and female, to fill cohorts. The balance beam test, a sensitive measure of neuromotor coordination, showed that mice given rotenone were less coordinated, but that co-treatment with PMX-500FI significantly improved performance. However, the effect of rotenone when comparing gender was markedly more severe in male mice. Female mice experienced significantly less change in body weight ($p < 0.05$), outperforming male mice in all OFT categories and also in the wire hang test. By analyzing genders separately we hoped to better understand the varying response by *PARK2* mice and found that male mice performed equally poorly in all tests, suggesting that male mice with parkin deficiency may be more sensitive to the effects of

rotenone than female counterparts. Female mice co-treated with PMX-500FI saw improved performance on the balance beam test. IHC analysis with TH labeling of SNpc neurons also revealed an inconsistent effect produced by rotenone on male versus female mouse brains. Due to limited *PARK2* mice being available to populate this study small group sizes and mixed gender were necessary, leaving us with questions as to the role gender might play. This finding supports the need for further work with this model to investigate the gender-linked susceptibility to rotenone and better understand the role of parkin protein. Going forward, cohorts should be populated with all male or all female, and all male cohorts may provide a more reliable model as our work suggests they have greater susceptibility to rotenone.

CONCLUSION

As long as treatment of mitochondrial diseases is focused on symptom relief, appropriately assessing and quantifying those symptoms in animal models is important for preclinical research. In the absence of animal models that accurately mimic human diseases caused by mtDNA mutations, models that disrupt mitochondrial function, especially the function of mitochondrial CI, represent the best options for studies of this kind. These models are valuable tools to assess therapies for mitochondrial disease and other neurodegenerative disorders, and model refinement continues to be necessary for thorough evaluation of treatments. Though a direct correlation has not yet been established between PMX-mediated neuroprotection and improved neuromotor performance in rats, it is clear that PMX compounds have a protective effect and our findings warrant further investigation into their therapeutic use.

REFERENCES

- Abdin, A.A., and Sarhan, N.I. (2011). Intervention of mitochondrial dysfunction-oxidative stress-dependent apoptosis as a possible neuroprotective mechanism of alpha-lipoic acid against rotenone-induced parkinsonism and l-dopa toxicity. *Neurosci. Res.* *71*, 387–395.
- Ali, S.F., Binienda, Z.K., and Imam, S.Z. (2011). Molecular aspects of dopaminergic neurodegeneration: Gene-environment interaction in parkin dysfunction. *Int. J. Environ. Res. Public Health* *8*, 4702–4713.
- Allen, a L., Luo, C., Montgomery, D.L., Rajput, A.H., Robinson, C. a, and Rajput, A.H. (2009). Vascular pathology in male Lewis rats following short-term, low-dose rotenone administration. *Vet. Pathol.* *46*, 776–782.
- Betarbet, R., Sherer, T.B., Mackenzie, G., Garcia-osuna, M., Panov, A. V, and Greenamyre, J.T. (2000). Chronic systemic pesticide exposure reproduces features of Parkinson’s disease. *Nat. Neurosci.* *3*, 1301–1306.
- Betarbet, R., Anderson, L.R., Gearing, M., Hodges, T.R., Fritz, J.J., Lah, J.J., and Levey, A.I. (2008). Fas-associated factor 1 and Parkinson’s disease. *Neurobiol. Dis.* *31*, 309–315.
- Cannon, J.R., Tapias, V.M., Na, H.M., Honick, A.S., Drolet, R.E., and Greenamyre, J.T. (2009). A high reproducibile rotenone model of Parkinson’s disease. *Neurobiol Dis* *34*, 279–290.
- Casarejos, M.J., Menendez, J., Solano, R.M., Rodriguez-Navarro, J.A., Garcia De Yebenes, J., and Mena, M.A. (2006). Susceptibility to rotenone is increased in neurons from parkin null mice and is reduced by minocycline. *J. Neurochem.* *97*, 934–946.
- Celardo, I., Martins, L.M., and Gandhi, S. (2014). Unravelling mitochondrial pathways to Parkinson’s disease. *Br. J. Pharmacol.* *171*, 1943–1957.
- Chaturvedi, R.K., and Beal, M.F. (2013). Mitochondrial diseases of the brain. *Free Radic. Biol. Med.* *63*, 1–29.
- Chen, Z., Guo, L., Zhang, Y., Walzem, R.L., Pendergast, J.S., Printz, R.L., Morris, L.C., Matafonova, E., Stien, X., Kang, L., et al. (2014). Incorporation of therapeutically modified bacteria into Gut microbiota inhibits obesity. *J. Clin. Invest.* *124*, 3391–3406.

Chinta, S.J., and Andersen, J.K. (2005). Dopaminergic neurons. *Int. J. Biochem. Cell Biol.* 37, 942–946.

Chou, A.H., Chen, S.Y., Yeh, T.H., Weng, Y.H., and Wang, H.L. (2011). HDAC inhibitor sodium butyrate reverses transcriptional downregulation and ameliorates ataxic symptoms in a transgenic mouse model of SCA3. *Neurobiol. Dis.* 41, 481–488.

Davie, J.R. (2003). Inhibition of histone deacetylase activity by butyrate. *J. Nutr.* 133, 2485S – 2493S.

Dokmanovic, M., Clarke, C., and Marks, P. a (2007). Histone deacetylase inhibitors: overview and perspectives. *Mol. Cancer Res.* 5, 981–989.

Gardian, G., Yang, L., Cleren, C., Calingasan, N.Y., Klivenyi, P., and Beal, M.F. (2004). Neuroprotective effects of phenylbutyrate against MPTP neurotoxicity. *Neuromolecular Med.* 5, 235–241.

Goldberg, M.S., Fleming, S.M., Palacino, J.J., Cepeda, C., Lam, H.A., Bhatnagar, A., Meloni, E.G., Wu, N., Ackerson, L.C., Klapstein, G.J., et al. (2003). Parkin-deficient Mice Exhibit Nigrostriatal Deficits but not Loss of Dopaminergic Neurons. *J. Biol. Chem.* 278, 43628–43635.

Hicks, A.A., Pétursson, H., Jónsson, T., Stefánsson, H., Jóhannsdóttir, H.S., Sainz, J., Frigge, M.L., Kong, A., Gulcher, J.R., Stefánsson, K., et al. (2002). A susceptibility gene for late-onset idiopathic Parkinson's disease. *Ann. Neurol.* 52, 549–555.

Imaizumi, N., Kwang Lee, K., Zhang, C., and Boelsterli, U.A. (2015). Mechanisms of cell death pathway activation following drug-induced inhibition of mitochondrial complex I. *Redox Biol.* 4, 279–288.

Irwin, M.H., Parameshwaran, K., and Pinkert, C.A. (2013). Mouse models of mitochondrial complex I dysfunction. *Int. J. Biochem. Cell Biol.* 45, 34–40.

Irwin, M.H., Moos, W.H., Faller, D. V., Steliou, K., and Pinkert, C.A. (2016). Epigenetic Treatment of Neurodegenerative Disorders: Alzheimer and Parkinson Diseases. *Drug Dev. Res.* 77, 109-123.

Jalali-Nadoushan, M., and Roghani, M. (2013). Alpha-lipoic acid protects against 6-hydroxydopamine-induced neurotoxicity in a rat model of hemi-parkinsonism. *Brain Res.* 1505, 68–74.

Jenner, P., and Jenner, P. (1991). Oxidative stress as a cause of Parkinson's disease. *Acta Neurol. Scand.* 84, 6–15.

Jiang, Q., Yan, Z., and Feng, J. (2006). Neurotrophic factors stabilize microtubules and protect against rotenone toxicity on dopaminergic neurons. *J. Biol. Chem.* *281*, 29391–29400.

Kane, L.A., Youle, R.J., Deas, E., Wood, N.W., Plun-Favreau, H., Fransson, A., Ruusala, A., Aspenström, P., Frederick, R.L., McCaffery, J.M., et al. (2011). PINK1 and Parkin Flag Miro to Direct Mitochondrial Traffic. *Cell* *147*, 721–723.

Kikyo, N., Tada, M., Tada, T., and Surani, M.A. (1997). Mapping of the eukaryotic initiation factor eIF-1A gene, *Eif1a*, to mouse chromosome 12D-E by FISH. *Mamm. Genome* *8*, 376.

Kitada, T., Asakawa, S., Hattori, N., Matsumine, H., Yamamura, Y., Minoshima, S., Yokochi, M., Mizuno, Y., and Shimizu, N. (1998). Mutations in the parkin gene cause autosomal recessive juvenile parkinsonism. *Nature* *392*, 605–608.

Kösel, S., Hofhaus, G., Maassen, A., Vieregge, P., and Graeber, M.B. (1999). Role of mitochondria in Parkinson disease. *Biol. Chem.* *380*, 865–870.

Lapointe, N., St-Hilaire, M., Martinoli, M.G., Blanchet, J., Gould, P., Rouillard, C., and Cicchetti, F. (2004). Rotenone induces non-specific central nervous system and systemic toxicity. *FASEB J.* *18*, 717–719.

Lazarou, M., Sliter, D.A., Kane, L.A., Sarraf, S.A., Wang, C., Burman, J.L., Sideris, D.P., Fogel, A.I., and Youle, R.J. (2015). The ubiquitin kinase PINK1 recruits autophagy receptors to induce mitophagy. *Nature* *524*, 309–314.

Luo, Y., Hoffer, A., Hoffer, B., and Qi, X. (2015). Mitochondria: A therapeutic target for Parkinson's disease? *Int. J. Mol. Sci.* *16*, 20704–20730.

Narendra, D., Tanaka, A., Suen, D.-F., and Youle, R.J. (2008). Parkin is recruited selectively to impaired mitochondria and promotes their autophagy. *J. Cell Biol.* *183*, 795–803.

Narendra, D.P., Jin, S.M., Tanaka, A., Suen, D.F., Gautier, C.A., Shen, J., Cookson, M.R., and Youle, R.J. (2010). PINK1 is selectively stabilized on impaired mitochondria to activate Parkin. *PLoS Biol.* *8*.

Novak, I. (2012). Mitophagy: a complex mechanism of mitochondrial removal. *Antioxid. Redox Signal.* *17*, 794–802.

Palacino, J.J., Sagi, D., Goldberg, M.S., Krauss, S., Motz, C., Wacker, M., Klose, J., and Shen, J. (2004). Mitochondrial dysfunction and oxidative damage in parkin-deficient mice. *J. Biol. Chem.* *279*, 18614–18622.

- Panov, A., Dikalov, S., Shalbuyeva, N., Taylor, G., Sherer, T., and Greenamyre, J.T. (2005). Rotenone model of Parkinson disease: Multiple brain mitochondria dysfunctions after short term systemic rotenone intoxication. *J. Biol. Chem.* *280*, 42026–42035.
- Parameshwaran, K., Irwin, M.H., Steliou, K., and Pinkert, C.A. (2012). Protection by an antioxidant of rotenone-induced neuromotor decline, reactive oxygen species generation and cellular stress in mouse brain. *Pharmacol. Biochem. Behav.* *101*, 487–492.
- Parameshwaran, K., Irwin, M.H., Steliou, K., Suppiramaniam, V., and Pinkert, C.A. (2015). Antioxidant-Mediated Reversal of Oxidative Damage in Mouse Modeling of Complex I Inhibition. *Drug Dev. Res.* *76*, 72–81.
- Perier, C., Tieu, K., Guégan, C., Caspersen, C., Jackson-Lewis, V., Carelli, V., Martinuzzi, A., Hirano, M., Przedborski, S., Vila, M., et al. (2005). Complex I deficiency primes Bax-dependent neuronal apoptosis through mitochondrial oxidative damage. *Proc. Natl. Acad. Sci. U. S. A.* *102*, 19126–19131.
- Pickrell, A.M., Pinto, M., and Moraes, C.T. (2013). Mouse models of Parkinson's disease associated with mitochondrial dysfunction. *Mol. Cell. Neurosci.* *55*, 87–94.
- Reeve, A., Meagher, M., Lax, N., Simcox, E., Hepplewhite, P., Jaros, E., and Turnbull, D. (2013). The impact of pathogenic mitochondrial DNA mutations on substantia nigra neurons. *J. Neurosci.* *33*, 10790–10801.
- Ren, Y., and Feng, J. (2007). Rotenone selectively kills serotonergic neurons through a microtubule-dependent mechanism. *J. Neurochem.* *103*, 303–311.
- Sharma, L.K., Lu, J., and Bai, Y. (2009). Mitochondrial respiratory complex I: structure, function and implication in human diseases. *Curr. Med. Chem.* *16*, 1266–1277.
- Sherer, T.B., Kim, J.-H., Betarbet, R., and Greenamyre, J.T. (2003). Subcutaneous Rotenone Exposure Causes Highly Selective Dopaminergic Degeneration and α -Synuclein Aggregation. *Exp. Neurol.* *179*, 9–16.
- Solano, R.M., Casarejos, M.J., Menendez-Cuervo, J., Rodriguez-Navarro, J.A., Garcia de Yébenes, J., and Mena, M.A. (2008). Glial Dysfunction in Parkin Null Mice: Effects of Aging. *J. Neurosci.* *28*, 598–611.
- Steliou, K., Faller, D. V., Pinkert, C.A., Irwin, M.H., and Moos, W.H. (2015). Bioprotective carnitinooids: Lipoic acid, butyrate, and mitochondria-targeting to treat radiation injury: Mitochondrial drugs come of age. *Drug Dev. Res.* *76*, 167–175.

Sul, J.W., Park, M.Y., Shin, J., Kim, Y.R., Yoo, S.E., Kong, Y.Y., Kwon, K.S., Lee, Y.H., and Kim, E. (2013). Accumulation of the parkin substrate, FAF1, plays a key role in the dopaminergic neurodegeneration. *Hum. Mol. Genet.* *22*, 1558–1573.

Tsang, A.H.K., and Chung, K.K.K. (2009). Oxidative and nitrosative stress in Parkinson's disease. *Biochim. Biophys. Acta - Mol. Basis Dis.* *1792*, 643–650.

Volmar, C.H., and Wahlestedt, C.R. (2015). Histone deacetylases (HDACs) and brain function. *Neuroepigenetics* *1*, 20–27.

Wallace, D.C. (2010). Mitochondrial DNA mutations in disease and aging. *Environ. Mol. Mutagen.* *51*, 440-450.

Wrangel, C. von, Schwabe, K., John, N., Krauss, J.K., and Alam, M. (2015). The rotenone-induced rat model of Parkinson's disease: Behavioral and electrophysiological findings. *Behav. Brain Res.* *279*, 52–61.

Zaitone, S.A., Abo-Elmatty, D.M., and Shaalan, A.A. (2012). Acetyl-L-carnitine and alpha-lipoic acid affect rotenone-induced damage in nigral dopaminergic neurons of rat brain, implication for Parkinson's disease therapy. *Pharmacol. Biochem. Behav.* *100*, 347–360.