

Revisiting the OSHA Hand Speed Constant

by

Richard F. Garnett

A dissertation submitted to the Graduate Faculty of
Auburn University
in partial fulfillment of the
requirements for the Degree of
Doctor of Philosophy

Auburn, Alabama
December 16, 2017

Keywords: Hand Speed, After-Reach, Dual Palm Button, Machine Guarding, Over-Reach

Copyright 2017 by Richard F. Garnett

Approved by

Gerald A. Davis, Chair, Professor of Industrial and Systems Engineering
Sean Gallagher, Associate Professor of Industrial and Systems Engineering
Richard F. Sese, Associate Professor of Industrial and Systems Engineering
Mark C. Schall Jr., Assistant Professor of Industrial and Systems Engineering

Abstract

This research focused on after-reach and over-reach in automated systems. OSHA uses a hand speed constant developed in 1935 (1.6 m/s) to calculate the “safe distance” on dual palm buttons and presence sensing devices. The 1.6 m/s value was later adopted by ANSI and RIA for “point-of-operation” safeguarding on robotic/automated systems. Several studies have found hand-speed values that exceed the 1.6 m/s value used in US safety regulations. The results of this study were:

- 1) For the simulated press experiment, the 95th percentile hand-speed from the lower button was 1.51 m/s and the 95th percentile hand speed from the upper buttons was 2.83 m/s.

The study found that the hand speed between the UB and LB positions are significantly different, which implies that the use of a single hand speed constant for both locations is inappropriate.

- 2) For over-reach applications, the study found that a hand speed constant between 3.5 m/s to 3.9 m/s would protect 95% of a population age 20-30 years old in a situation with unconstrained hand position (no dual palm buttons).
- 3) A comparison of the speed measured by Vicon (optical motion capture) and Xsens (IMU motion capture) demonstrated a general agreement (average bias 0.19 m/s) between the two technologies. Based on this analysis, an IMU-based system could be a viable option for measuring after-reach speed on the factory floor in the future.

Acknowledgments

As I look back over the preparation of this Dissertation, I am struck by how much support I have received through this learning process.

I wish to express my appreciation to my committee chair, Dr. Jerry Davis, for his guidance and mentorship through this journey. It was Dr. Davis, who when an old engineer came by his office and asked to join the PhD program, said yes. I would like to thank Dr. Mark Schall who's advice on funding helped me get the research going and who's insightful comments on my work was always helpful. I would like to thank Dr. Richard Sesek, who's love of research and concern for his students I hope to emulate in the future. I would also like to thank Dr. Sean Gallagher who's deep knowledge of statistics is impressive and was extremely helpful in structuring and analyzing my experiments.

I would like to thank my fellow Occupational Safety Ergonomic (OSE) graduate students. We often talk about OSE being a "family." When you embark on your research and need volunteers as subjects, research assistants, helpers to analyze data, and so forth, you realize how important it is that you have a "family" to help. So thank-you Rong, Sarah, Conner, Xuanxuan, Bob, Fehmi, Alan, Mohamed, Austin, and all the other members of my OSE family that helped me along the way.

I would like to thank the Deep South Center for Occupational Health and Safety, the Sunshine Education & Research Center, and the National Institute for Occupational Safety for funding support.

Finally, I would like to thank my wife of thirty-six years, for her support on this journey. It was my wife, Carol, who when I decided to quit a good job, sell the house, and move to Auburn to get a PhD said “let’s do it.” It is hard to have a more supportive partner in your life than that.

Saying thank-you doesn’t seem to be enough to express my gratitude and appreciation, but thank you all.

Table of Contents

Abstract.....	ii
Acknowledgments.....	iii
List of Tables	ix
List of Illustrations.....	x
List of Abbreviations	xii
Chapter 1 Introduction	1
1.1 Machine Guarding Standards	3
1.2 Manufacturing Machinery and Injury Rates	4
1.3 Power Presses and Hand Speed	6
1.4 Research Objectives.....	8
1.5 Research and Dissertation Organization	10
Chapter 2 Review of the Literature	11
2.1 After-reach and Hand-speed.....	12
2.2 Safety Standards	13
2.3 After-reach Research	15
2.4 Inertial Measurement Systems	21
2.5 Bland-Altman Analysis	25
2.6 Gaps in the Literature and Opportunities for Research	27

Chapter 3 Evaluating the OSHA Hand Speed Constant in Stamping Press Applications	28
3.1 Abstract.....	28
3.2 Introduction	29
3.3 Power Presses	29
3.4 Hazards and Regulations	31
3.5 OSHA Requirements	33
3.6 Concerns with Hand Speed Constant.....	36
3.7 Research Aim	43
3.8 Equipment	44
3.9 Subjects.....	46
3.10 Results of the Experiment.....	47
3.11 Discussion of Results	52
3.12 Conclusions.....	57
Chapter 4 Evaluating Hand Speed in Automated Systems using Presence Sensing Devices	59
4.1 Abstract.....	59
4.2 Introduction	60
4.3 Stamping Presses and Hand Speed	61
4.4 Calculating Safe Distance and Concerns with the Hand Speed Constant	62
4.5 Presses and Light Curtains.....	65
4.6 Robots and Hand Speed	67
4.7 Research Aim	71
4.8 Equipment	73
4.9 Experimental Process.....	75

4.10 Results of the Experiment.....	78
4.11 Discussion of Results	82
4.12 Conclusions.....	84
Chapter 5 Evaluating an IMU Based System for After-Reach Speed Measurement	85
5.1 Abstract.....	85
5.2 Introduction	86
5.3 Inertial Measurement Systems	88
5.4 IMUs versus Optical Motion Capture.....	90
5.5 Research Aim	94
5.6 Equipment	95
5.7 Subjects.....	97
5.8 Data Collection and Analysis	99
5.9 Statistics	101
5.10 Discussion of Results	104
5.11 Conclusions.....	105
Chapter 6 Conclusions	107
6.1 Summary of Findings	107
6.2 Limitations of the Study.....	109
6.3 Recommendations for Future Research.....	110
6.4 Acknowledgments.....	111
References	112
Appendix 1: Process Flow Diagram for Hand Speed Experiment	121
Appendix 2: Design of Experiment	122

Appendix 3: Anthropometry Procedures for Hand Speed Study.....	124
Appendix 4: Procedures for Hand Speed Measurement Experiment	127
Appendix 5: Layout for Xsens & Vicon Sensors.....	132
Appendix 6: Screening and Anthropometry Data Form.....	133
Appendix 7: Informed Consent Form.....	134

List of Tables

Table 2.1: Summary of IMU Accuracy Research.....	22
Table 3.1: Hand Speed ANOVA with Gender as a Between Subjects Variable and Button Position (UB versus LB) as a Within Subjects Variable	51
Table 3.2: Percentile Values and Corresponding After-reach Speeds for LB and UB Positions	51
Table 3-3: Summary of LB Hand Speed, Various Studies	53
Table 3-4: Summary of UB Hand Speed, Various Studies.....	54
Table 4.1: Average Hand Speed by Gender, Target Position, Hand, & Start Position.....	78
Table 4.2: ANOVA for Dominate and Non-Dominate, Average Hand Speed vs Gender, Target Position, & Start Position	79
Table 4.3: Average Hand Speed Dominate and Non-Dominate Hand for Male and Female Subjects (Target Position Data Pooled)	83
Table 5.1: Summary of IMU Accuracy Research	91

List of Illustrations

Figure 1.1: Estimate of USA Population Overhead Reach.....	4
Figure 1.2: Trend in the Rate of Nonfatal Workplace Amputation, Private Industry, 1992-1999	5
Figure 3.1: Typical Manual Loaded Power Press.....	30
Figure 3.2: Typical Dual Palm Button Start Station for Simulated Mechanical Press.....	36
Figure 3.3: Waist Height and Shoulder Height Dual Palm Button Layout	45
Figure 3.4: Layout of the Reflective Markers Used to Identify Kinematic Segments	46
Figure 3.5: Subject at the Simulated Press at the Upper Dual Palm Button (UB)	48
Figure 3.6: Hand Orientation at LB Position and Vicon Track of LB to Target	55
Figure 3.7: Hand Orientation at UB Position and Vicon Track of UB to Target	55
Figure 3.8: Velocity of Movement from UB & LB Position to Target	56
Figure 4.1: Typical Press with Presence Sensing Device (Light Curtain).....	62
Figure 4.2: Free Hand After-reach Target	74
Figure 4.3: Layout of the Reflective Markers Used to Identify Kinematic Segments	75
Figure 4.4: Layout of the Five (5) Start Locations and Three (3) Target Locations	76
Figure 4.5 Interaction Plot of Mean Hand Speed for Gender by Start-Position.....	80
Figure 4.6 Interaction Plot of Mean Hand Speed for Target Position by Start Position.....	81
Figure 4.7: Start Position Versus Average Hand Speed Dominate and Non-Dominate Hand (Gender and Target Position Data Pooled)	84

Figure 5.1: Calculation Flow Diagram of an Inertial Navigation System	89
Figure 5.2: Waist Height and Shoulder Height Dual Palm Button Layout	97
Figure 5.3: Layout of the Reflective Markers & IMUs Used to Identify Kinematic Segment ..	98
Figure 5.4: Trace Showing Hand Path Traveled During an After-reach Event (Based on Vicon Data)	101
Figure 5.5: Bland-Altman Plot of UB After-reach Speed, Comparison of Vicon and Xsens ..	103
Figure 5.6: Bland-Altman Plot of LB After-reach Speed, Comparison of Vicon and Xsens...	104

List of Abbreviations

AHRS	Attitude and Heading Reference Systems
ANSI	American National Standard Institute
ANOVA	Analysis of Variance
C	Intrusion Toward Danger Zone (ISO)
CFR	Code of Federal Regulations
CIB	Current Intelligence Bulletin
cm	Centimeter(s)
D_{pf}	Sensitivity of PSD
D_s	Safe Distance (ANSI/RIA)
$D(s)$	Safe Distance (OSHA)
ft	Feet
H_i	Alternative Hypothesis
H_o	Null Hypothesis
Hz	Frequency, cycles/second
IEC	International Electrotechnical Commission
IMU(s)	Inertial Measurement Unit(s)
in	Inch
in/sec	Inch(s) per Second

IQR	Interquartile Range
IRB	Institutional Review Board
ISO	International Organization for Standardization
K	Approach Speed of Body Part (ISO)
Lb(s)	Pound(s)
LB	Lower Dual Palm Button
LOA	Limits of Agreement
mm	Millimeter(s)
mm/s	Millimeter(s) per Second
MoCap	Motion Capture
m/s	Meters per Second
NFPA	National Fire Protection Association
NIOSH	National Institute for Occupational Safety and Health
OMC	Optical Motion Capture
OSHA	Occupational Safety and Health Administration
PSD	Presence Sensing Device
RIA	Robotic Industries Association
RMS	Root Mean Square
RMSE	Root Mean Square Error
S	Safe Distance (ISO)
SD	Standard Deviation
SP	Start Position
SPM	Strokes Per Minute

T	Overall Stopping Time (ISO)
T _c	Stopping Time of Control System
T _r	Response Time of Safeguarding Device
T _s	Stopping Time of machine/equipment
T(s)	Press Closing Time
TR	Technical Report
UB	Upper Dual Palm Button
US	United States

Chapter 1

Introduction

The Occupational Safety and Health Act of 1970 established the Occupational Safety and Health Administration (OSHA) and empowered it to create regulations to improve workplace safety. Developing standards for a myriad of workplace safety issues was a huge task. In general, OSHA relied on industrial standards as the basis for its regulations. (Stender, 1975) As noted in Plant Engineering magazine:

“Most of the general industry standards were adopted from existing national consensus standards published by the American National Standards Institute (ANSI) and the National Fire Protection Association (NFPA). . . . After all, these were the standards most responsible employers had been observing for years.” (“OSHA and Machine Guarding: Aging Standards,” Aging

However, the OSHA standards were not always as conservative or as “science based” as safety professionals would have liked. In fact, the National Institute for Occupational Safety and Health (NIOSH) indicated that their initial progress on developing safety standards was slowed by “a dearth of investigative information to provide support to criteria for safety standards.” (Powell &

Christensen, 1975). The weak basis of some standards has led researchers to study OSHA requirements to confirm that they are applicable to today's workforce. For example, OSHA's machine guarding standards (1910.217(c)(2)(i)(a)) specify the maximum "hole size" allowed in guarding to prevent a worker's fingers or hands from becoming entangled in equipment at the point of operation. (OSHA 1910.217, 2013) OSHA's hole sizing criteria was based on anthropometric measurements of a small sample of workers conducted by Liberty Mutual Insurance Company in the 1940s. Researchers have worked to confirm that these standards are "safe," since they were based on a relatively small sample size and on a workforce that was less diverse and contained fewer women than the modern day workforce. (Vaillancourt & Snook, 1995)

The revision of the original OSHA standards and the development of new standards, is a long and difficult process that can take several years. (Allen, 2012) This has led to standards which are not updated as often as consensus standards, and which can fall behind the technological, demographic and anthropometric changes in the work place. For example, OSHA 1910.140 establishes standards for fall protection systems. Fall protection was originally incorporated into OSHA's Walking-Working Surfaces & Fall Protection requirements that were promulgated in April 1971. These standards were based on "pre-1971 editions of American National Standards Institute (ANSI) consensus standards." (Abrams, 2016) At that time, OSHA set the drop test weight (and hence the design basis) of personal fall arrest systems at a body weight of 220 pounds (lbs). In 2017, these standards were revised and reissued to bring them more into harmony with the OSHA construction standards and to more accurately reflect the body mass of

today's work force. The revised standards set the design basis for personal fall arrest systems (drop test) at 250 lbs (1910.140(e)(1)(ii)(A)).

1.1 Machine Guarding Standards

One of the largest group of standards OSHA developed governs machine safety and machine guarding. OSHA 1910.212(a)(3)(ii) established the general requirements for Machine Guarding and requires that all guarding be “designed and constructed as to prevent the operator from having any part of his body in the danger zone during the operating cycle.” (OSHA 1910.212, 1970)

Many of OSHA's original standards were “specification-based.” They provided direction and measureable parameters within the specifications employers had to meet. (Stender, 1975)

However, the basis for some of the OSHA specifications can be difficult to understand. For example, OSHA sets specifications for overhead mounted fans:

“Exposure of blades. When the periphery of the blades of a fan is less than seven (7) feet above the floor or working level, the blades shall be guarded. The guard shall have openings no larger than one-half (1/2) inch.” [OSHA 1910.212(a)(5)]

This requirement allows fans mounted slightly above seven feet (84 inches) to be left unguarded. However, according to the 1988 Anthropometric Survey of US Army Personnel, males above the 20th percentile in height and females above the 85th percentile in height have an overhead reach greater than seven (7) ft OSHA's seven-foot standard will allow a substantial majority of the

male population and a lesser portion of the female population to reach overhead into an unguarded fan blade from a normal walking surface.

European standards (ISO/TC 199 Safety of Machinery, 2008) require that hazards be determined by conducting a risk assessment and that low hazard areas be protected to a height of 8.2 feet and that high hazard areas be protected to a height of 8.9 feet (British Standard, 2011) These are much more conservative recommendations than the OSHA regulation. Based on the 1988 Anthropometric Survey of US Army Personnel, a guarding height of eight (8) feet would protect the male population up to the 97th percentile and 100% of the female population for overhead reach from a normal walking surface (Figure 1.1).

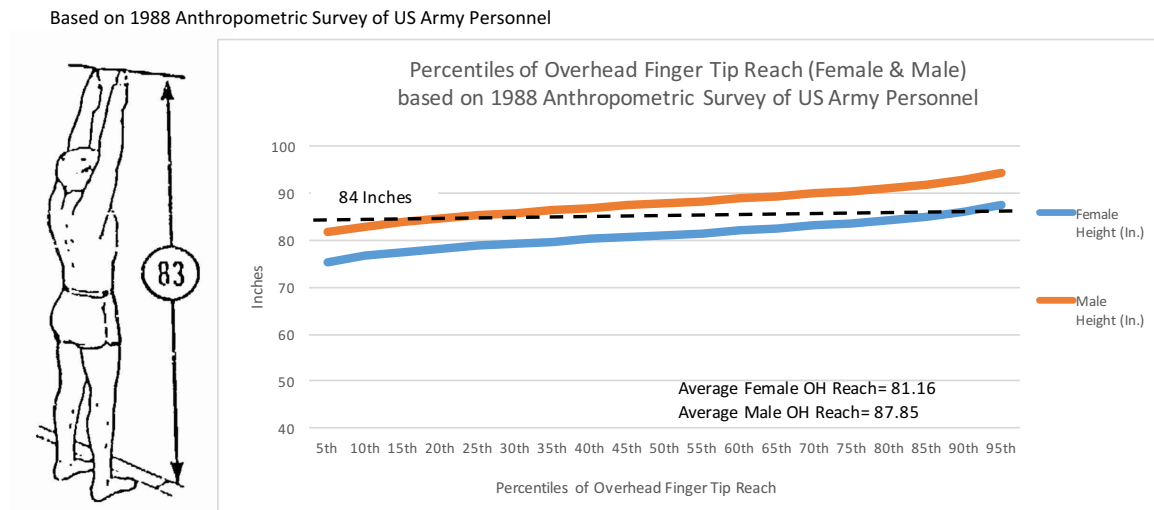

Figure 1.1: Estimate of USA Population Overhead Reach

Graph is based on data from (Gordon et al., 1989)

1.2 Manufacturing Machinery and Injury Rates

Hand and finger injuries account for 30% of all work injuries and 36.2% of these injuries are caused by hands caught in machines or struck by metal objects. Of these injuries, 10% result in fractures or amputations. (Oleske & Hahn, 1992) The majority of non-fatal amputation (53%) occurs in the manufacturing industry, which represents only 19% of the total work population. (Brown, 2003)

OSHA has a strong focus on machine safety in manufacturing operations. In addition to general machine guarding regulations, OSHA established standards for specific types of manufacturing equipment: woodworking machinery (OSHA 1910.213, 1984), abrasive wheel machinery (OSHA 1910.215, 1996), mills and calendars (OSHA 1910.216, 1996) mechanical power presses (OSHA 1910.217, 2013), forging machines (OSHA 1910.218, 1996), and mechanical power transmission apparatus. (OSHA 1910.219, 2004) OSHA's emphasis on machine safety has reaped benefits (Figure 1.2). The rate of machine-related fatalities caused by stationary machinery declined by 56% from 1992 to 2010 (Marsh & Fosbroke, 2015) as has the rate of nonfatal workplace amputation. (Brown, 2003)

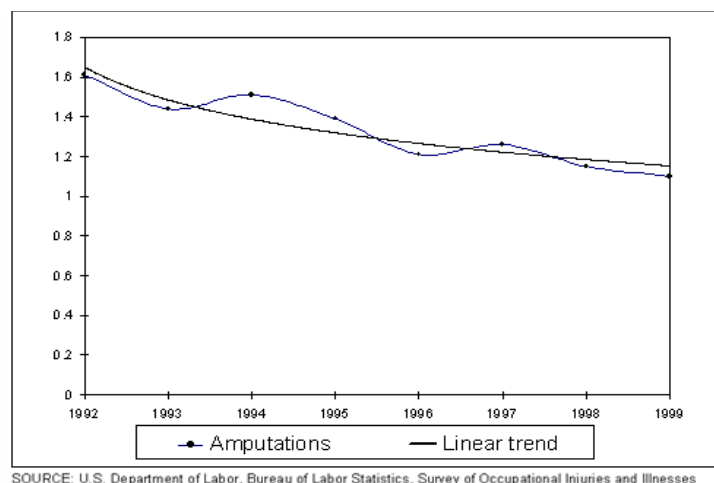

Figure 1.2: Trend in the Rate of Nonfatal Workplace Amputation, Private Industry, 1992- 1999

Figure Taken from “Amputation: A Continuing Workplace Hazard” (Brown, 2003)

However, there is more work to be done in dealing with machine safety. Even with the improvements seen in the amputation rate, manufacturing remains more dangerous than other areas of employment. In 1999, the rate of non-fatal workplace amputations for manufacturing was 2.9 per 10,000 full time workers; this value exceeded the national average rate for non-fatal workplace amputations, which was 1.1 per 10,000 workers. (Brown, 2003) As Brown noted, “in spite of OSHA's efforts, manufacturing industries continued to experience some of the highest numbers and rates of nonfatal workplace amputations among all industries.” (Brown, 2003)

1.3 Power Presses and Hand Speed

Stamping presses are one of the oldest forms of metal working machinery. They are designed to bend or punch metal and can be mechanical or hydraulically driven. They are a relatively simple device consisting of a stationary bed and a moving ram. As explained by NIOSH:

“The press shears, punches, forms, or assembles metal or other material by cutting or shaping, using combination dies attached to the ram and bed. The mechanical power press operates on a reciprocating motion principle . . . A workpiece is fed into the lower die, either automatically or manually, and the machine cycle is initiated. On the down stroke, the ram (with an upper die) moves toward the work area, or point of operation. When the upper and lower dies press together on the stock material, a re-formed piece is produced. Once the down stroke is completed, the newly formed workpiece can be removed, a new workpiece fed into the die, and the process repeated.”

Within the manufacturing industry, stamping presses consistently rank as one of the most dangerous type of process equipment. A study by NIOSH estimated that 10% of all amputations in manufacturing are caused by power presses (NIOSH, 1987) and McCaffrey found that 49% of power press injuries are amputations. (McCaffrey, 1981)

The “point of operation” on a press is an inherently dangerous area. To load the press an operator manually loads the stock into the “pinch point” generated by a ram closing into a die. This puts the operator in danger if the ram closes while his/her hand(s) are in the “point of operation.” OSHA Section 1910.217 requires that the control circuit of a press contain either dual palm buttons to initiate the cycle or a “presence sensing point of operation device.” According to Pizatella and Moll:

“Several safeguarding methods are used to reduce the risk of injury to power press operators. The use of dual (or two-hand) palm buttons to actuate the press cycle is one method. This safeguard requires that the operator depress both palm buttons concurrently to initiate and, on certain types of presses, to continue machine motion. Theoretically, if both of the operator's hands are required to actuate the machine at a location remote from the point of operation, then the operator's risk of being injured will be reduced.”

(Pizatella & Moll, 1987)

After-reach occurs when a worker attempts to reach into the press after the downward motion of the ram has been actuated. This is believed to be an inadvertent, automatic response by the operator to clear a process upset in the die. Preventing this is referred to as “after-reach protection” and is an important safety issue in power press operation (Pizatella & Moll, 1987).

OSHA requires that the buttons used to actuate the press be positioned so the press cannot be started and the operator still have time to reach into the die before it closes. The distance the start buttons are positioned from the point of operation is called the “safe distance” or setback distance. The setback distance is calculated using Equation 1.1.

$$D(s) = 63 \text{ inches/second} * T(s) \quad \text{Equation 1.1}$$

Where $D(s)$ is the safe distance and $T(s)$ is the press closing time (1910.217(c)(3)(iii)(d)). Per the OSHA standards, 63 inches/second (or 1.6 m/s) is a hand speed constant, which represents the speed at which workers can perform an after-reach movement.

1.4 Research Objectives

OSHA’s hand speed constant is based on research by Oskar Löbl conducted in Germany in 1935. OSHA adopted this value in the standards and Manufacturers have used this value to establish dual palm button locations for stamping presses. OSHA’s hand speed constant is applied to press operation, but is also used in many non-press calculations. For example, it appears in the RIA standard (R15.06-1999 Industrial Robot Safeguarding) and in the ANSI formulas for light curtain set back distance (ANSI B11.3-2002 E8.6.2.2.7).

Several studies have found hand speed values that exceed the value developed by Löbl are attainable (Pizatella, Etherton, Jensen, & Oppold, 1983), (Horton, Pizatella, & Plummer, 1986), (Jensen & Stobbe, 2016). This is especially true for younger operators (operators less than 30 years old) who have the fastest hand speeds. (Pizatella et al., 1983) The specific aim of the first experiment will be to collect hand speed data to statistically determine the maximum attainable

hand speed from a fixed (dual palm button) start position for typical “young” operators. The results of this experiment will be compared to OSHA’s hand speed constant to determine if OSHA’s constant is conservative enough to protect operators in typical press systems.

Research by Jensen and Stobbe indicates that hand speed varies based on the position of the two hand start buttons on a press (Jensen & Stobbe, 2016). Manual loading of robotic or automated work stations is common in industry. Some of these “collaborative workspaces” do not have dual hand start stations (automatic start after loading), so the operator’s posture is not limited (as is typical in press operation). If hand start position can increase hand speed, it could mean that OSHA’s 1.6 m/s standard is not conservative enough to protect operators in some robotic/automated applications. The second experiment will determine if a worker could achieve hand speeds greater than 1.6 m/s if their hands (start position) were not constrained by two hand start buttons by measuring hand speed from multiple start positions to various target heights.

The third and final experiment will investigate hand speed measurement technology. Optical motion capture systems (OMC) are considered the benchmark for recording body movements, joint angles, motion speed and so forth. However, OMC is difficult to use in industrial applications, since it requires multiple cameras, special lighting, and unobstructed line of sight of the entire motion path. If Jensen and Stobbe are correct and maximum hand speed is not a constant, but a variable, practitioners will need a more flexible method to determine hand speed for various work situations. Inertial measurement units (IMUs) have the potential to fill this gap if the hand speed measurements they record are accurate. The third experiment will compare the hand speed measurements made using MoCap (a Vicon system, Vicon Oxford, 14 Minns

Business Park, West Way, Oxford England, OX2 0JB) versus hand speed measurements captured by IMUs (an Xsens system, Xsens North America Inc., 10557 Jefferson Blvd, Suite C, Culver City, CA 90232, USA) to determine the IMU's accuracy and repeatability for hand speed measurement.

1.5 Research and Dissertation Organization

The chapters of this dissertation are organized according to the Auburn University dissertation guide (Auburn University, 2015). This dissertation consists of six chapters. Chapter One is an introduction of the dissertation topic and Chapter Six is a conclusion. Chapter Two is a literature review of the articles, peer reviewed articles, and regulations related to hand speed, machine guarding and speed measurement using inertial measurement units (IMUs).

Chapters Three, Four, and Five are stand-alone manuscripts describing purpose, method, results, discussion, and conclusions of three applicable experiments related to hand speed and hand speed measurement. Chapter Three reports operator hand speed measured from traditional two hand capture buttons in a machine press application. Chapter Four examines hand speed in unconstrained applications (no two hand capture buttons) typical for a manually loaded robotic cell. Chapter Five reports an experiment that compares hand speed measured using optical motion capture technology (Vicon) vs hand speed measurements captured by inertial measurement units (Xsens). The Appendices contain details outlining the recruitment of human subjects, Institutional Review Board (IRB) consent forms, experiment methodology, and other information to support the results presented in Chapters Three, Four and Five.

Chapter 2

Review of the Literature

The following literature review includes five parts: 1) A basic discussion of after-reach, hand-speed, and ballistic movements, 2) A review of safety standards, which set safe distance calculations to protect press operators from after-reach accidents, 3) A literature review of studies conducted to determine hand-speed during simulated after-reach events, 4) A review of Inertial Measurement Systems (IMUs) technology which can be used to measure hand-speed, and 5) A review of Bland-Altman analysis, a technique designed to compare different measuring devices. An understanding of these methods and studies will provide a knowledge base which will allow the identification of gaps in the literature and areas for additional study.

The experimental chapters in this dissertation are written in the “journal article format,” therefore much of the background literature will be repeated in Chapters 3, 4, and 5 and additional specific literature will be discussed in each chapter.

2.1 After-reach and Hand-speed

After-reach is a safety concern peculiar to power press and machine operation. Power presses can be manually or automatically loaded and unloaded. Manually loaded machines have more production flexibility than those automatically loaded, but increase the risk of operator injury since it requires a reach into the pinch point caused by the die closing. As Pizatella stated:

“Some power presses can be hand fed, which increases their flexibility. However, along with this flexibility comes the potential for serious injury to the operator. The very forming action of the machine- in other words, the downward closing motion of the ram and dies- creates a potentially hazardous point-of-operation that can cause an injury if any part of a worker's body is caught between these pinch points.” (Pizatella & Moll, 1987)

After-reach occurs when a worker attempts to reach into the press after the downward motion of the ram has begun. This is believed to be an inadvertent response to clear a process upset in the die (NIOSH, 1987).

Hand-speed and hand motion have been studied for over 100 years. (Lin, 2009) Some of the earliest research was conducted by Fitts. Fitts studied “aimed movements.” His research was based on information theory and feedback concepts of control theory (Fitts, 1954). This theory assumes that humans make multiple course and speed corrections through a hand movement toward a target (Crossman & Goodeve, 1983). This type of movement is accurate, but is not necessarily the fastest movement. This loss of speed in exchange for accuracy is referred to as the “speed-accuracy trade-off.” Humans generally trade speed for accuracy in aiming movements (terminal control movements) and tracking movements (path control movements) (Lin, 2009),

(Bairstow, 1987). As noted by Beggs “The relative sizes of the acceleration and deceleration phases depended on terminal accuracy; accurate movements tended to have longer deceleration phases” (Beggs & Howarth, 1972)

After-reach is a ballistic movement. A ballistic movement (which generates the fastest hand-speed) consists of a rapid motion that is “triggered automatically” and “is carried out without any form of feedback monitoring once it is initiated” (Flowers, 1975). A ballistic movement consists of “an initial impulse accelerating the hand/foot toward the target, followed by a decelerating impulse to stop the movement. There is no mid-course correction” (Prasad, Kellokumpu, & Davis, 2006). Hand speed is variable and is determined by both age and gender (Era, Jokela, & Heikkinen, 1986), (Au, Seah, Li, & Tan, 2015), (Welford, 1984).

2.2 Safety Standards

The metal working industry consistently ranks high in machine-related worker injury rates. The incidence rates for lost-time injuries in metal fabrication in 2015 was 133.1 cases per 10,000 compared to U.S. private industry as a whole at 105.2 cases per 10,000 metal workers; amputations in the metal fabrication were 2.6 per 10,000 metal workers versus 0.6 per 10,000 workers in private industry (Parker et al., 2015). Within the metal working industry, stamping presses consistently rank as one of the most dangerous types of process equipment (Yamin, Parker, Brosseau, Gordon, & Xi, 2014) (Yamin, Bejan, Parker, Xi, & Brosseau, 2016). A study by NIOSH estimated that 10% of all amputations in manufacturing are caused by power presses (NIOSH, 1987) and McCaffrey found that 49% of power press injuries are amputations (McCaffrey, 1981).

The first standards for power presses, were consensus safety standards, written by the American Standards Association (the forerunner of the American National Standard Institute (ANSI)), and were issued in 1926 (Fuller, 1993). The Occupational Safety and Health Administration (OSHA) was established by the Occupational Safety and Health Act in 1970. OSHA issued the first regulations on mechanical power in 1971 based on ANSI B11.1-1971. ANSI recommended the use of point-of-operation devices “preventing or stopping the normal stroking of the press, or both, if the operator’s hands are inadvertently placed in the point-of-operation” (ANSI B11.1-1971 5.3(1)).

The original OSHA 1910.217 standard included a “no hands in die” requirement (part of ANSI B11.1-1971), which precluded manual loading/unloading of power presses (Baldwin, 1976). After petitions from the metal working industry the 1910.217 standard was revised in 1973 to allow “hands in die” loading. However, the revised standard included improvements to point-of-operation safeguarding (Baldwin, 1976). These improvements include the incorporation of dual palm buttons, light curtains, and other safety devices into power press systems.

Palm buttons are a “two-hand-capture” device intended to reduce the risk of injury when operating a press. They are designed to allow the machine to cycle only if both buttons are pressed at the same time, this reduces the chance an operator’s hands could be in the die during the start of the downward stroke of the press. The setback distance (or safe distance) for the two-hand palm buttons also minimizes “after-reach” errors. Per OSHA 1910.217(c)(3)(vii)(c), the setback distance is calculated using Equation 2.1:

$$D(s) = 63 \text{ inches/second} * T(s) \quad \text{Equation (2.1).}$$

Where $D(s)$ is the safe distance and $T(s)$ hazard time or press closing time. The value of 63 inches/second (or 1.6 m/s) is the hand speed constant, which represents the speed at which workers can perform an after-reach movement. OSHA's 63 inch/sec (1.6 m/s) hand speed constant is based on research by Löbl in 1935 (OSHA Etool Website, 2017).

OSHA 1910.217(c)(3)(vii)(c) mandates the use of 63 inches/sec (1.6 m/s) constant to calculate the safe distance (setback distance) for dual palm buttons on presses and light curtains (OSHA 1910.217, 2013). The use of dual palm buttons is fairly common on mechanical presses. A study in Finland found that 54% of the presses surveyed included dual palm buttons in the start sequence (Suokas, 1983).

In 1982 when ANSI reissued B11, ANSI included OSHA's formula for safe distance calculations, but included a B11.-1982 5.3.2(5) that stated:

“The 63 inch/second figure is derived from the OSHA (1974) regulations. Under certain circumstances a higher hand speed may be necessary. Small parts in conjunction with fast operator speed should be viewed with particular concern”(ANSI, 1982).

2.3 After-reach Research

The first after-reach study was performed by Oskar Löbl in 1935. Presses in Löbl's day used full revolution clutches and did not have electromagnetic controls. Operators actuated mechanical levers to engage the flywheel and cycle the machine. In an early attempt at two-hand-capture, presses were designed with two levers, so both hands were required to actuate the clutch. No

information was available to determine how far away the start levers should be to prevent an operator from committing an after-reach error once they had initiated the cycle of the press (Lobl, 1935). Löbl designed a simulated press and used oscillography to measure the time it took a subject to push the horizontal start levers, release the levers, and touch a “target plate.” Löbl calculated hand speed based on the elapsed time divided by an estimate of the distance the hand traveled, which represented the average velocity over the subject’s “hand path.” His experiment consisted of 79 trials using five (5) male subjects. His calculated value of 1.58 m/s (rounded to 1.6 m/s) was the maximum speed attained by a single test subject. Based on this single data point, Löbl estimated that the maximum hand speed a human could obtain was 1.6 m/s. He noted in his conclusions that the “conditions for regripping” (i.e. after-reach) were more complicated than assumed by press designers (Lobl, 1935).

In the 1980’s, after OSHA incorporated the 1.6 m/s constant into the standards, NIOSH researchers began examining Löbl’s conclusions on safe distance. Multiple studies were conducted to attempt to find a “hand-speed constant” that would allow calculation of the “safe distance.”

In 1981 Davies & Mebarki conducted research into the hand speed of “press brakes utilizing photo-electric safety devices.” Their subjects consisted of thirty-six (36) males 16-56 years old and sixteen females 16-50 years old. They found a significant difference in male versus female hand speed and old versus young hand speed. Davies & Mebarki were concerned about the hand speeds generated by young males and suggested that “the young male group is at risk when

operating press guards fitted with photo-electric safety devices” even if the press met the British safety standards. (Davies & Mebarki, 1983)

In 1983 Pizatella & Etherton (two NIOSH investigators) published “Investigation of the After-Reach Hazard in Two-Hand Controlled Power Press Operation” (Pizatella, Etherton, Jensen, & Oppold, 1983). They built a simulated press (no moving ram) with dual palm buttons (rather than levers), and used a photo-optic speed measuring system to capture hand speed. They tested subjects with dual palm buttons located at waist height and shoulder height to estimate after-reach speed. In the simulation, operators placed wood blocks into a “nest” in the faux-press to mimic the placement of work pieces into a die. The researchers (randomly) used puffs of air to displace the wooden block and simulate an after-reach event. The operators were instructed to reach into the press and realign the block as quickly as possible. The researchers used eight (8) subjects between the ages of 29 to 38 as operators. Each subject performed 20 random after-reaches from each dual palm button location. Pizatella and Etherton, using the average hand speed from the waist and shoulder height, found a significant difference between the hand speed of individuals with subjects averaging 1.08-1.66 m/s at the upper button and 0.76-1.10 m/s at the lower button. As Pizatella noted:

“The hand speed values in the lower location were consistently less than 1.6 m/s, while in the upper location hand speed values for several of the subjects were greater than 1.6 m/s. Any safety distance calculated with the use of 1.6 m/s would unsafely place the two-hand actuators too close to the point of operation when the hand speed was actually greater than 1.6 m/s. This finding identifies an important relationship between actuator location and hand-reach speed.”

In 1985 Pizatella and Moll conducted a detailed study on after-reach speed using a specially built simulator. The new machine included a simulated reciprocating ram, waist/shoulder height dual palm button stations, photo-optic sensor for speed measurement, wooden block work pieces, and a mechanical plunger designed to kick work pieces from the die and initiate an after-reach event. Using 60 subjects, all of whom were industrial workers and 85% whom had previously worked on power presses, the researchers measured after-reach speed four times at each button location for each subject. The fastest of the four hand speed trials (at each location) was used in the data analysis (Pizatella & Moll, 1987). Pizatella and Moll found that the mean hand speed for the subjects in their study was 1.34 ± 0.68 m/s. They found significant inter-subject differences in hand-speed based on age and gender. Male subjects averaged 1.58 ± 0.72 m/s and female subjects averaged 1.07 ± 0.52 m/s. Male workers from 20-30 years old could generate the fastest hand speeds achieving speeds greater than 2.0 m/s. The location of the subject's start position (waist level vs shoulder level) also influenced speed. Start position at shoulder height allowed workers to generate 15% faster hand speeds than waist height start position (waist height 1.23 ± 0.70 m/s versus shoulder height 1.45 ± 0.65 m/s). "The results of this study indicated that in order to protect 95% of power press operators from the after-reach hazard, the hand speed constant may need to be higher than the current 1.6 m/s value" (Pizatella & Moll, 1987).

Jensen and Pizatella conducted a critical review of eleven different press/hand speed studies that appeared in the literature. The researchers felt only studies that used machine operators as subjects, were based on the maximum after-reach speed, and used a test apparatus that provided a realistic simulation of a press were valid estimates of after-reach speed. They found multiple

studies in which subjects achieved hand speeds faster than the 1.6 m/s and where hand speed varied based on dual palm button position. They indicated “that the use of a single hand speed constant appears to oversimplify the situation. Both actuator button location and distance has been found to affect after-reach speed.” (Jensen & Pizatella, 1986)

In 1986 Horton published the results of a study using five male and five female subjects to evaluate the after-reach speed at the three most common dual palm button positions and button orientations (shoulder level-vertical, waist level-vertical, and waist level-horizontal). Horton used the simulated press developed by Pizatella and Moll to gather hand speed data at various button locations and orientations. His “subjects exhibited the fastest mean hand speeds at the horizontal, waist-level location (2.13 m/sec \pm 1.03) compared to the vertical, shoulder-level location (2.01 m/sec \pm 1.11) and the vertical, waist-level location (1.74 m/sec \pm 0.42).” Like Pizatella, he noted that the 1.6 m/s hand speed constant was not conservative enough to protect all operators (Horton, Pizatella, & Plummer, 1986).

Jensen and Sinkule studied the risk of amputation for press operators based on age in 1988. They analyzed Workman’s Compensation data from 28 states over a three-year period and found the risk of amputation was higher in young operators. Although they noted a correlation in age and risk they could not identify a cause. Jensen and Sinkule also noted that the increased risk could be due to a lack of training, differences in skill, or a willingness to bypass operating standards among young workers (Jensen & Sinkule, 1988).

In March 1987, in response to the evidence developed by NIOSH scientists, NIOSH issued Current Intelligence Bulletin (CIB) 49. This CIB warned employers that NIOSH believed the OSHA hand speed constant was not protective for all workers and that additional safety precautions were necessary for some workers:

“Caution must be exercised in evaluating each power press set-up and operation to ensure that an adequate safety distance is maintained at all times. Employers should consider evaluating individual press operators to determine if they are exceeding the current OSHA hand-speed constant” (NIOSH, 1987).

NIOSH did not recommend a method for evaluating press operators’ hand speed.

Jensen (in a journal article and in his dissertation) used the press built by Pizatella to study after-reach speed with three palm button placements. He measured the hand speed of nine students and noted that after-reach hand speed varied both with placement of the buttons and distance within placement. Jensen theorized that after-reach speed was not a constant, but rather a variable that changed based on hand start position and distance to target. He recommended “instead of looking for a constant . . . a new model be developed for predicting after-reach time of press operators . . . with an equation that more closely matches experimental data” (Jensen & Stobbe, 2016). In his dissertation, Jensen attempted to find this “new equation” by analyzing hand-speed data against seven different models (including Fitt’s Law and ballistic models). He was unsuccessful in finding a model that provided a “good fit” and suggested the development of a biomechanical model to calculate after-reach (Jensen, 1989).

In 2017 Jensen reexamined the data generated by Pizatella and Moll, to determine what value would represent the 95th percentile of after-reach speed. Jensen noted that the 95th percentile value is an important number, since this value is typically considered a compromise between protection and practicality by regulators. He found that the 95th percentile for an upper button placement was 2.64 m/s and for a lower button placement was 1.88 m/s (Jensen, 2017).

In an experiment to determine the safety system that would allow the highest productivity, Katoh, et al. compared the production rate of a press equipped with dual palm buttons versus a light curtain. They conducted a simple study using four males in their twenties and four males in their fifties. The younger subjects exhibited hand speeds faster than the OSHA constant using dual palm buttons. Both young and old subjects exceeded the OSHA's 1.6 m/s hand speed constant when using presence sensing devices (PSD) to initiate the machine cycle (Katoh et al., 2001).

2.4 Inertial Measurement Systems

Inertial Measurement Systems (IMUs) are “a small and portable device that combines information obtained from multiple electromechanical sensors (e.g. accelerometers, gyroscopes, and magnetometers) to estimate the spatial orientation of an object through the use of recursive sensor fusion algorithms such as a Kalman or complementary weighting algorithm” (Schall, Fethke, Chen, Oyama, & Douphrate, 2016). Because of their ease of use and the potential for use on the factory floor for motion capture, ergonomic assessment and so forth in the workplace, there has been a flurry of research activity to demonstrate IMU accuracy and compare it to the

“gold standard”, optical motion capture (OMC). Table 2.1 summarizes the research effort and the findings generated:

Table 2.1: Summary of IMU Accuracy Research

Date	Study	Findings	Reference
2001	Validation of Inertial Measurement Units With an Optoelectronic System for Whole-Body Motion Analysis	Compared to OMC; Studied joint angle “ . . . error remained under 5° RMSE during handling tasks, which shows potential to track workers during their daily labor.”	(Robert-Lachaine, Mecheri, Larue, & Plamondon, 2017)
2005	Inertial Measurements of Upper Limb Motion	Development of portable IMU motion tracker to aid in home rehab of stroke victims. System demonstrated less than 5% error (arm angle, slow movements) compared to OMC.	(Zhou, Hu, & Tao, 2006)
2007	Ambulatory Measurement of Arm Orientation	Study of upper arm kinetics using an “ambulatory system.” IMU vs OMC using RMS. IMU software model that incorporates “joint restrictions” improves accuracy.	(Luinge, Veltink, & Baten, 2007)
2007	Inertial Sensors for Motion Detection of Human Upper Limbs	Study of portable IMU motion tracker to aid in home rehab of stroke victims. “The motion detector using the proposed kinematic model only has drifts in the measurements. Fusion of acceleration and orientation data can effectively solve the drift problem without the involvement of a Kalman filter.”	(Zhou & Hu, 2007)
2008	Magnetic Distortion in Motion Labs, Implications for Validating Inertial Magnetic Sensors	Compared to OMC; Studied joint angle. Accuracy in the presence of iron was acceptable but performance deteriorated in 20-30 sec	(de Vries, Veeger, Baten, & van der Helm, 2009)
2008	Dynamic Accuracy of Inertial Measurement Units During Simple Pendulum	Tested IMU against OMC . . . “The IMU measurement of pendulum motion using the vendor's Kalman	(Brodie, Walmsley, & Page, 2008)

	Motion	filter algorithm did not compare well with the video motion capture with a RMS error of between 8.5° and 11.7° depending on the length and type of pendulum swing. The maximum orientation error was greater than 30°, occurring approximately eight seconds into the motion.	
2008	Use of Multiple Wearable Inertial Sensors in Upper Limb Motion Tracking	IMU vs OMC measuring wrist & elbow joint angle. “Experimental results demonstrate that this new system, compared to an optical motion tracker, has RMS position errors that are normally less than 0.01 m, and RMS angle errors that are 2.5°–4.8°.”	(Zhou, Stone, Hu, & Harris, 2008)
2009	A Distributed Wearable, Wireless Sensor System for Evaluating Professional Baseball Pitchers and Batters	Compared to OMC; Studied Acceleration & Arm Speed; Compared joint angle. Evaluation of Pitchers and Batters using a specially designed high speed data capture (200 Hz) IMU.	(Lapinski, Berkson, Gill, Reinold, & Paradiso, 2009)
2009	Accuracy of Inertial Motion Sensors in Static, Quasistatic, and Complex Dynamic Motion	Tested IMU against OMC using RMSE analysis. Studied arm movement during static, quasistatic, and dynamic motion. RMS error was 1.9° to 3.5° during pendulum movement. Error higher in complex arm movement. Acceptable accuracy for field study.	(Godwin, Agnew, & Stevenson, 2009)
2010	Feasibility of Using Inertial Sensors to Assess Human Movement	Comparison of IMU system to electromagnetic sensors for hip measurement during walking. Measurements obtained for hip joint movement during walking were flexion 38.8°, extension 6.6°, step frequency 1.02 Hz. “We conclude that the inertial sensors studied have the potential to be used for motion analysis and clinical research.”	(Saber-Sheikh, Bryant, Glazzard, Hamel, & Lee, 2010)
2012	Shoulder and Elbow Joint Angle Tracking With	Improved Kalman filter algorithm increases accuracy. Tested IMU	(El-Gohary &

	Inertial Sensors	against OMC using RMSE analysis. “RS angle error of less than 8° for all shoulder and elbow angles.”	McNames, 2012)
2013	Inertial Measures of Motion for Clinical Biomechanics: Comparative Assessment of Accuracy under Controlled Conditions - Effect of Velocity	IMU “systems demonstrated good absolute static accuracy (mean error, 0.5°) and clinically acceptable absolute accuracy under condition of slow motions (mean error between 0.5° and 3.1°). In slow motions, relative accuracy varied from 2° to 7° depending on the type of AHRS and the type of rotation. Absolute and relative accuracy were significantly affected by velocity during sustained motions. “	(Lebel, Boissy, Hamel, & Duval, 2013)
2013	Performance Evaluation of a Wearable Inertial Motion Capture System for Capturing Physical Exposure During Manual Material Handling	Application of IMU in a work environment (lifting/material handling). Tested IMU against OMC to compare joint angle and joint velocity. “The IMU system yield peak kinematic values that differed up to 28% from OMC system.” Acceptable accuracy for field use.	(Kim & Nussbaum, 2013)
2015	A Comparison of Instrumentation Methods to Estimate Thoracolumbar Motion in Field-Based Occupational Studies	Compared to Lumbar Motion Monitor using RMSE. “Results suggest investigators should consider computing (Robert-Lachaine et al., 2017)thoracolumbar trunk motion as a function of estimates from multiple IMUs using fusion algorithms rather than using a single accelerometer secured to the sternum in field-based studies.”	(Schall, Fethke, Chen, & Gerr, 2015)
2016	Validation of Inertial Measurement Units With an Optoelectronic System for Whole-Body Motion Analysis	Compared to OMC; Evaluated Joint Angle using RMSE “Error remained under 5° RMSE during handling tasks, which shows potential to track workers during their daily labor.”	(Robert-Lachaine, Mecheri, Larue, & Plamondon, 2017)
2016	Accuracy and Repeatability	Compared to OMC “The accuracy and repeatability of an inertial	(Schall, Fethke,

	of an Inertial Measurement Unit System for Field-Based Occupational Studies	measurement unit (IMU) system for directly measuring trunk angular displacement and upper arm elevation were evaluated over eight hours . . . Sample-to-sample root mean square differences between the IMU and OMC system ranged from 4.1° to 6.6° for the trunk and 7.2°–12.1° for the upper arm depending on the processing method . . . "IMU systems may serve as an acceptable instrument for directly measuring trunk and upper arm postures in field-based occupational exposure assessment studies with long sampling durations."	Chen, Oyama & Douphrate, 2016)
--	---	---	--------------------------------

Due to the potential to use IMUS as an in-situ measurement device, the IMU literature shows a rigorous effort to determine IMU accuracy as compared to optical motion capture. Optical motion capture is considered the gold standard for segmental kinematic measurements (Ceseracciu, Sawacha, & Cobelli, 2014). Most of the IMU effort has been focused on non-ballistic slow speed movements such as gait, shoulder movement, or trunk movement. Most researchers prefer to use root mean square analysis of the motion curves and the measurement of joint angle as a measure of IMU accuracy.

2.5 Bland-Altman Analysis

The Bland-Altman methodology is a statistical analysis technique developed in the 1980’s. Researchers in the medical field are often faced with comparing “two different methods of measuring some quantity” (Altman & Bland, 1983). The two techniques are often compared via correlation or by comparing means. However, two techniques designed to measure the same physical property can exhibit a high correlation without exhibiting high accuracy. As Giavarina notes, “two methods that are designed to measure the same variable should have good correlation

when a set of samples are chosen in such manner that the property to be determined varies considerably” (Giavarina, 2015). Correlation does not necessarily demonstrate agreement, “a non-significant difference is not an indication of equality” (McLaughlin, 2013). Bland-Altman is designed to compare two methods of measure and estimate their agreement. If the methods “agree” then they are interchangeable and either can be used without a significant loss of accuracy, (Bland & Altman, 1995), (Bland & Altman, 2010).

The Bland-Altman technique is a graphical method:

“The Bland-Altman method calculates the mean difference between two methods of measurement (the ‘bias’), and 95% limits of agreement as the mean difference (2 SD) [or more precisely (1.96 SD)]. It is expected that the 95% limits include 95% of differences between the two measurement methods. The plot is commonly called a Bland-Altman plot and the associated method is usually called the Bland-Altman method” (Myles & Cui, 2007).

The method has been used extensively (cited over 20,000 times) in scientific journals to compare two methods of measure and determine if they agree (McLaughlin, 2013) Bland and Altman have continued to extend their method in 2010 to experiments with repeated measure (Bland & Altman, 2010). Zou suggested improvements to the method of calculating the limits of agreement (LOA) based on a one-way random effects mode when analyzing repeated measures and the true experimental value varies trial to trial (Zou, 2013).

2.6 Gaps in the Literature and Opportunities for Research

- 1) The literature indicates that hand-speed is a variable influenced by start position. It is not a constant in the sense that OSHA uses it in the “safe distance” equation. Most after-reach speed calculations have used the maximum speed of multiple subject trials in order to generate a “protective” hand speed constant. A better approach might be to sample the press operating population most at risk (those with the fastest hand speed) and determine the 95th percentile hand speed of that population. The 95th percentile value is an important number, since this value is typically considered a compromise between protection and practicality for regulators. The workers with the fastest hand-speed are young males 20-30 years old.

- 2) The majority of after-reach measurement has focused on dual palm buttons. Research into over-reach speed, where the subject’s start position is not constrained by the location of dual palm buttons (machines equipped with presence sensing devices e.g. light curtains), is limited.

- 3) NIOSH has recommended that industry measure the hand-speed of individual operators in the field to determine “safe distance” for dual palm buttons and presence sensing devices. NIOSH has not provided a method for accomplishing this measurement. Inertial Measurement Systems are small, portable devices that measure acceleration and velocity using miniature electro-mechanical sensors. If IMUs demonstrate acceptable accuracy when measuring ballistic movements, they could be used for measurement of operator hand-speed on the factory floor.

Chapter 3

Evaluating the OSHA Hand Speed Constant in Stamping Press Applications

3.1 Abstract

Occupational Safety and Health Administration (OSHA) utilizes ‘hand speed’ as a critical machine guarding parameter. OSHA’s current hand speed constant is based upon research conducted by Löbl (1935), who used a fixed hand starting position to estimate the maximum human hand speed of five males at 1.6 m/s (63 in/s). Sixty (60) college students participated in the present study to ascertain a more accurate estimate of the 95th percentile hand speed for machine guarding applications. Results indicated that the hand speed between the upper and lower dual palm button positions are significantly different, and for the upper button location OSHA’s hand speed constant may not be conservative enough to protect some operators. Specifically, the 95th percentile hand speed from the lower button was 1.51 m/s (protective for > 95% of those tested), but the 95th percentile hand speed from the upper buttons was 2.83 m/s (protective < 10% of those tested). These results suggest that control location with respect to the point-of-operation should be considered since hand speed is significantly impacted by relative position.

3.2 Introduction

Stamping presses are reciprocating machines that are designed to trim, blank, or pierce sheet metal using a die designed to create the shape of the part required (Cattell, 2008). Stamping presses are one of the oldest forms of metal working technology. They were used in Germany as early as 1890 to produce bicycle parts and were quickly adopted by United States manufacturers due to the competitive cost of the parts they produce. The quality of parts produced by stamping presses rival cast parts, but are much less expensive (Thomas Engineering Company, 2015).

Early presses were mechanical (powered by a driven flywheel) and were manually loaded and unloaded. The need to manually feed early presses made them dangerous to operate, since loading the machine placed the operator's hand(s) into the point-of-operation formed when the upper and lower dies closed during the down stroke. Articles began to appear in the literature by 1909 which outlined safety improvements to press design and the first consensus safety standard, written by the American Standards Association (the forerunner of the American National Standard Institute (ANSI)), was issued in 1926 (Fuller, 1993).

3.3 Power Presses

Today, stamping presses can be mechanically, hydraulically, or pneumatically driven with, mechanical power presses being the most common (NIOSH, 1987). The major components of a mechanical press are the flywheel, stationary bed, and a movable ram. A die, designed to cut or form the part, is mounted in the press. One section of the die (moving side or upper side) is attached to the ram and the other section of the die (fixed side or lower side) is attached to the bed of the machine (also called the bolster) (Marovich, 2015).

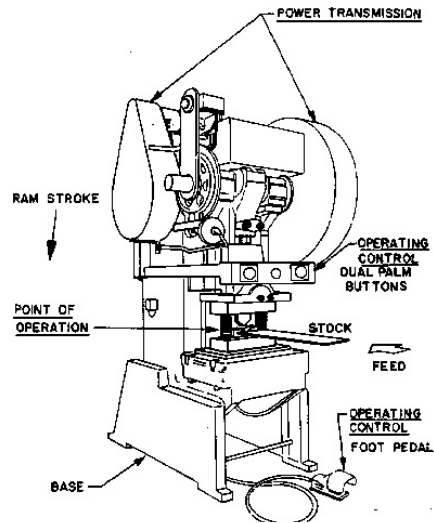

Figure 3.1: Typical Manual Loaded Power Press

Figure Taken from “Amputation: A Continuing Workplace Hazard”

CDC - NIOSH Publications and Products - Injuries and Amputations Resulting from Work with Mechanical Power Presses (NIOSH, 1987)

A mechanical press (Figure 3.1) contains a large, heavy flywheel driven by an electric motor. The rotation of the flywheel is transmitted to a movable ram by an eccentric crankshaft that is linked to the flywheel by a clutch. To control the press, the operator engages the clutch, which transmits the rotation of the flywheel to the movable ram through the crankshaft. The rotation of the eccentric crankshaft moves the ram up and down. Depending on the size of the flywheel and the gearing of the drive mechanism, a stamping press can close with a force between 30 and 600 tons and reciprocate at speeds between 125 to 1000 strokes per minute (SPM) (Cattell, 2008).

Stamping presses can be divided into two general mechanical categories depending on the design of the flywheel clutch. Full-revolution clutches remain engaged for a full stroke once they are actuated; the machine ram makes a full cycle and cannot be stopped once the cycle has been

started. Part-revolution clutches can be disengaged during the down stroke to stop a full machine cycle. However, press rams are typically heavy and contain a significant amount of inertia, so stopping is not instantaneous in part-revolution machines. Typically, full-revolution presses pose a greater hazard to operators since the machine cycle cannot be stopped once it is started to avert an accident (NIOSH, 1987).

Power presses can be manually or automatically loaded and unloaded. Manually loaded machines have more production flexibility than those automatically loaded, but increase the risk of operator injury (Etherton, 1984). As Pizatella noted:

“Some power presses can be hand fed, which increases their flexibility. However, along with this flexibility comes the potential for serious injury to the operator. The very forming action of the machine, in other words, the downward closing motion of the ram and dies, creates a potentially hazardous point-of-operation that can cause an injury if any part of a worker's body is caught between these pinch points.” (Pizatella & Moll, 1987)

3.4 Hazards and Regulations

The metal working and metal fabrication industry consistently ranks high in machine-related worker injury rates. The incidence rates for lost-time injuries in metal fabrication in 2015 was 133.1 cases per 10,000 compared to U.S. private industry as a whole at 105.2 cases per 10,000 metal workers; amputations in the metal fabrication were 2.6 per 10,000 metal workers versus 0.6 per 10,000 workers in private industry (Parker et al., 2015). Within the metal working industry, stamping presses consistently rank as one of the most dangerous types of process equipment (Yamin, Parker, Brosseau, Gordon, & Xi, 2014) (Yamin, Bejan, Parker, Xi, &

Brosseau, 2016). A study by NIOSH estimated that 10% of all amputations in manufacturing are caused by power presses (NIOSH, 1987) and McCaffrey found that 49% of power press injuries are amputations (McCaffrey, 1981).

OSHA is aware of the hazards associated with power presses and has developed standards to address press safety. OSHA's Mechanical Power Press standard, issued in 1971, was based on ANSI B11.1-1971 (Baldwin, 1976). ANSI recommended the use of point-of-operation devices "preventing or stopping the normal stroking of the press, or both, if the operator's hands are inadvertently placed in the point-of-operation" (ANSI B11.1-1971 5.3(1)). The ANSI standard recommended the use of guards, presence-sensing devices, pullback devices, sweeps, two-hand trips, two-hand control devices and so forth to accomplish this. The ANSI standard also required "application of both of the operator's hands to the machine operating control during the die closing" (ANSI B11.1-1971 5.3(4)). ANSI did not provide any guidance on the setback distance for the two-hand controls, only that the location must be far enough away that the press would complete its stroke "before the operator's hands can inadvertently reach into the point-of-operation" (ANSI, 1971). The ANSI committee's most controversial recommendation was that all press equipment would be updated so "presswork should no longer require workers' hands in the hazardous die area" (Baldwin, 1976).

The original OSHA 1910.217 standard included all of the ANSI B11.1-1971 recommendations, including the controversial "no hands in die" requirement, a major issue for power press users. As one OSHA official noted, "the law would result in the obsolescence of thousands of useful dies that are still in the workplace and still of value." After petitions from the metal working

industry and the completion of an OSHA study that determined that a lack of guarding was more of an issue than after-reach errors, the 1910.217 standard was revised in 1973 to allow “hands in die” loading. However, the revised standard included changes to improve machine control reliability and point-of-operation safeguarding (Baldwin, 1976).

3.5 OSHA Requirements

The point-of-operation on a power press is an inherently dangerous area. To manually load a press an operator loads the stock into the pinch point generated by the ram closing into the die. This places the operator in danger if the ram closes while his/her hand(s) are in the point-of-operation. Due to the hazards, a number of safeguards (OSHA 1910.217, 2013) are typically installed on presses based on the design of the machine:

- a) For machines equipped with foot switch actuating: guarding, pullbacks and restraint devices.
- b) Dual palm buttons may be used for full-revolution clutch and part-revolution clutch machines.
- c) Presence-Sensing Devices (PSD) may be used, but are only applicable to machines equipped with part-revolution clutches

Machine cycle rates are faster using a foot switch since the press can be actuated immediately after the hands leave the point-of-operation (as opposed to after the operator’s hands travel to the palm buttons). However, the risk of amputation injuries are not as high for dual palm buttons, since foot switches can be inadvertently actuated, while the operator’s hands are in the point-of-operation (NIOSH, 1987).

Palm buttons are a two-hand-capture device intended to reduce the risk of hand injury when operating a press. They are designed to allow the machine to cycle only if both buttons are pressed at the same time, this ensures that an operator's hands cannot be in the die during the start of the downward stroke of the ram. The use of two-hand palm buttons also minimizes after-reach errors. After-reach occurs when a worker attempts to reach into the press after the downward motion of the ram has begun. This is believed to be an inadvertent response to clear a process upset in the die (NIOSH, 1987). The worker may notice scrap in the die or a miss-set blank and attempt to clear it after the machine cycle has started, but before the die closes. This may prevent damage to the die or the production of a scrap part, but can result in the worker's fingers, hand, or arm being in the point-of-operation when the press cycles.

29 CFR 1910.217 contains a number of provisions related to the safe design of power presses using dual palm-button controls:

- a) OSHA 1910.217(b)(7)(iv)(a) - The control system must be designed so that both dual palm buttons must be depressed and released (within a certain time period) for each press cycle ("anti-tie-down controls"). This eliminates the possibility that an operator can tie-down one of the buttons and use only one button to cycle the press.
- b) OSHA 1910.217(b)(7)(v)(c) - Mechanical power presses may only operate in a single-stroke (anti-repeat) mode. The flywheel clutch must be engaged and the press cycle only once each time the dual palm buttons are depressed.

- c) OSHA 1910.217(b)(7)(v)(a) - Both palm buttons shall be separated and have guarding to prevent an operator from intentionally or unintentionally cycling the press by "bridging" the palm buttons and starting the press without using both hands.
- d) OSHA 1910.217(c)(3)(vii)(c) - The distance the start buttons are positioned from the point-of-operation is called the safe distance or setback distance. To reduce the after-reach hazard, a minimum safety distance between the point-of-operation and the dual palm buttons is required on a press.

Per OSHA 1910.217(c)(3)(vii)(c), the setback distance is calculated using Equation 3.1:

$$D(s) = 63 \text{ inches/second} * T(s) \qquad \text{Equation (3.1).}$$

Where D(s) is the safe distance and T(s) hazard time or press closing time. Per the OSHA standards, 63 inches/second (or 1.6 m/s) is the hand speed constant, which represents the speed at which workers can perform an after-reach movement. For presses with part revolution clutches, the hazard time is the stopping time of the press ram after the clutch has been disengaged from the flywheel. On presses with full revolution clutches, the hazard time is the time for the ram to complete a down stroke.

OSHA 1910.217(c)(3)(vii)(c) uses the 63 inches/sec (1.6 m/s) to calculate the safe distance (setback distance) for dual palm buttons and 1910.217(c)(3)(iii)(e) uses the 63 inches/sec to calculate the setback distance for presence sensing devices, both were added to the OSHA standards in 1974. These revisions were added to strengthen the standard after the “no hands in die” requirements were removed to improve point-of-operation safeguarding.

The use of dual palm buttons (Figure 3.2) is fairly common on mechanical presses. A study of presses in Finland found that 54% of the presses surveyed included dual palm buttons in the start sequence (Suokas, 1983).

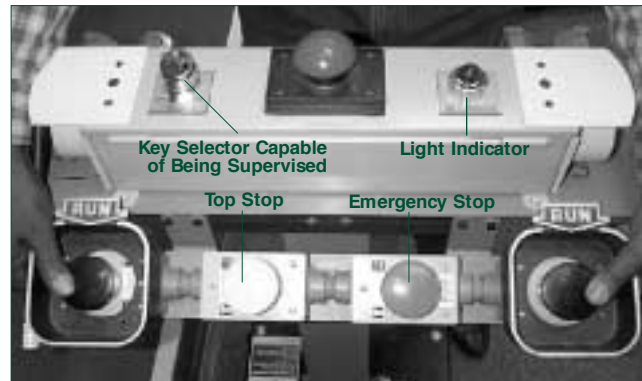

Figure 3.2: Typical Dual Palm Button Start Station

Figure Taken from “Safeguarding Equipment and Protecting Employees from Amputations”

OSHA 3170-02R 2007 (OSHA, 2007)

3.6 Concerns with Hand Speed Constant

OSHA’s 63 inch/sec (1.6 m/s) hand speed constant is based on research by Löbl in 1935 (OSHA Etool Website, 2017). Presses in Löbl’s day used full revolution clutches and did not have electromagnetic controls. Operators actuated mechanical levers to engage the flywheel clutch and begin the downward stroke of the ram. In an early attempt at two-hand-capture, presses were designed with two levers, so both hands were required to actuate the clutch. No information was available to determine how far away the start levers should be to prevent an operator from committing an after-reach error after they had initiated the cycle of the press (Löbl, 1935).

In a pioneering work, Löbl used oscillography to measure the time it took a subject to push the start levers (in the horizontal plane), release the lever, and move his hand until he touched a

“target plate” in a simulated stamping press. Löbl calculated hand speed based on the elapsed time over an estimate of the distance the hand traveled, so it represents the average velocity along the subject’s “hand path.” His experiment consisted of 79 trials conducted using five (5) male subjects. His calculated value of 1.58 m/s (rounded up to 1.6 m/s) was the maximum speed attained by one of his test subjects during the experiment. Based on this data, he estimated that the maximum hand speed a human could obtain was 1.6 m/s. Löbl noted in his conclusions that the “conditions for regripping” (his term for after-reach) was more complicated than assumed by the press designers and that, “It would be desirable if the experiments were repeated on real presses and with male and female operators” (Löbl, 1935).

OSHA’s inclusion of the 63 inch/sec constant in the 1974 press standard for after-reach protection was controversial. ANSI reissued B11.1 in 1982 and mirrored OSHA’s formula for safe distance calculations, but the comments for B11.-1982 5.3.2(5) noted:

“The 63 inch/second figure is derived from the OSHA (1974) regulations. Under certain circumstances a higher hand speed may be necessary. Small parts in conjunction with fast operator speed should be viewed with particular concern”(ANSI, 1982).

In the 1980’s, National Institute for Occupational Safety and Health (NIOSH) researchers began examining machine safety and reexamining Löbl’s conclusions on safe distance.

McCaffrey studied work related amputations based on workers’ compensation claims from the Bureau of Labor for 1977. He estimated that 21,000 amputations occurred in the USA in 1977. Sixty percent of these claims occurred in manufacturing even though manufacturing accounted

for only about 30% of employment at the time. According to his data, 91% of the amputations were fingers and 56% of these amputations involved machines. Workers being caught in, under, or between machines accounted for 51% of the injuries (McCaffrey, 1981).

In 1983 Pizatella et al. reproduced Löbl's experiment using a more sophisticated time measurement system (Pizatella, Etherton, Jensen, & Oppold, 1983). They built a simulated press (no moving ram) with dual palm buttons (rather than levers) to actuate the press, and used a photo-optic speed measuring system to capture hand speed. They tested the after-reach speed of operators with dual palm buttons located at waist height and shoulder height (the two most popular palm button locations for small power presses). For the experiment, operators placed wood blocks into a "nest" in the simulated press to mimic the placement of work pieces into a die. The researchers (randomly) fired puffs of air into the nest to displace the wooden block after it was placed. The operators were instructed to reach into the press and realign the block as quickly as possible after the block moved to simulate an after-reach event. The researchers used eight (8) subjects between the ages of 29 to 38 as operators. Each subject performed 20 random after-reaches from each button location. Pizatella et al., using the average hand speed from the waist and shoulder height, found a significant difference between the hand speed of individuals: "On the basis of the results of this study, it appears that standards based on a single-hand speed constant may be unnecessarily restrictive for some operators and not protective enough for others."

The research also found that hand speed was not constant between the upper and lower control locations; all the test subjects achieved faster hand speed from the upper controls (1.32 m/s) than from the lower controls (0.94 m/s) (Pizatella et al., 1983).

In 1985 (published in 1987) Pizatella and Moll conducted a definitive study on after-reach speed using a specially built simulator. The simulator included a reciprocating ram (spring loaded to eliminate pinch points), waist/shoulder height dual palm button stations, photo-optic sensor for speed measurement, wooden block work pieces, and a mechanical plunger designed to kick work pieces from the die and initiate an after-reach event. The experiment used 60 subjects (of various ages) all of whom were industrial workers and 85% whom had previously worked on power presses. The after-reach speed of each subject was measured four times at each button location; only the fastest of the four hand speed trials (at each location) was used in the data analysis (Pizatella & Moll, 1987).

Pizatella and Moll found that the mean hand speed for the subjects in their study was 1.34 ± 0.68 m/s. They found significant inter-subject differences in hand-speed based on age and gender. Male subjects averaged 1.58 ± 0.72 m/s and female subjects averaged 1.07 ± 0.52 m/s. Younger workers could generate significantly greater hand speed than older workers. Male workers from 20-30 years old could generate the fastest hand speed achieving speeds greater than 2.0 m/s. The location of the subject's start position (waist level vs shoulder level) also influenced speed. Start position at shoulder height allowed workers to generate 15% faster hand speeds than waist height start position (waist height 1.23 ± 0.70 m/s versus shoulder height 1.45 ± 0.65 m/s). (Pizatella & Moll, 1987)

Pizatella and Moll's study indicated that 1.6 m/s hand speed constant was protective of the average worker, but that operators exist in the general population that would not be protected and

workers younger than 30 years old were also not fully protected. Pizatella and Moll did not establish a maximum hand speed for workers younger than 30 years old (which would represent the maximum hand speed of the working population), since their sample size for young adult males (n=12) was too small to accurately extrapolate the population mean.

Pizatella and Moll's finding that hand speed is effected by age and gender has been supported in the literature (Era, Jokela, & Heikkinen, 1986), (Au, Seah, Li, & Tan, 2015), (Welford, 1984).

In 1986, Jensen and Pizatella conducted a critical review of eleven different press/hand speed studies that appeared in the literature. The researchers felt only studies that used machine operators as subjects, were based on the maximum after-reach speed, and used a test apparatus that provided a realistic simulation of a press were valid estimates of after-reach speed. Using this criteria, they found multiple studies in which subjects achieved hand speeds faster than the 1.6 m/s value and where hand speed varied based on hand start position. They indicated "that the use of a single hand speed constant appears to oversimplify the situation. Both actuator button location and distance has been found to affect after-reach speed." (Jensen & Pizatella, 1986)

In 1986 Horton et al. published the results of a study using five male and five female subjects to evaluate the after-reach speed at the three most common dual palm button positions and button orientations (shoulder level-vertical, waist level-vertical, and waist level-horizontal). Horton et al. used the simulated press developed by Pizatella and Moll, to gather hand speed data at the button locations and orientations. His subjects demonstrated the fastest after-reach speed at the waist level-horizontal button location (2.13 ± 1.03 m/s). Like Pizatella and Moll, he noted that

the 1.6 m/s hand speed constant was not conservative enough to protect all operators (Horton, Pizatella, & Plummer, 1986).

In March 1987, in response to the evidence amassed by research scientists (Etherton, Pizatella, Moll, Horton, and others) NIOSH issued Current Intelligence Bulletin (CIB) 49. CIBs are published by NIOSH “to disseminate new scientific information about occupational hazards.” CIB 49 (titled “Injuries and Amputations Resulting from Work with Mechanical Power Presses”) warned employers that NIOSH believed the OSHA hand speed constant was not protective for all workers and that additional safety precautions were necessary for some workers:

“Caution must be exercised in evaluating each power press set-up and operation to ensure that an adequate safety distance is maintained at all times. Employers should consider evaluating individual press operators to determine if they are exceeding the current OSHA hand-speed constant. If a worker is identified as being capable of exceeding the hand-speed constant, more positive means of point-of-operation safeguarding should be considered, such as fixed barrier guards.”

As part of his dissertation (and later published), Jensen investigated the impact of palm button placement on after-reach speed (Jensen & Stobbe, 2016). Jensen’s hypothesis was that hand speed was not a constant and was impacted by both button placement (shoulder height or waist height) and distance from the palm buttons to the point-of-operation. Jensen had access to the simulated press used by Pizatella and Moll, and used nine male subjects (without press work experience) to gather hand speed data at multiple button locations and geometries. He used young males because they had the fastest hand speeds in the Pizatella and Moll study. His

subjects averaged 1.59 m/s in the lower button placement and 2.24 m/s in the upper button placement. He recommended abandoning the “hand speed constant” concept in favor of a speed formula based on experimental data (Jensen & Stobbe, 2016) (Jensen, 1989).

Jensen and Sinkule studied the risk of amputation for press operators based on age. They analyzed Workman’s Compensation data from 28 states over a three-year period and found the risk of amputation was higher in young operators. Although they noted a correlation in age and risk they could not identify a cause. One possibility was the faster hand speed noted by Pizatella and Moll, but Jensen and Sinkule also noted that the increased risk could be due to a lack of training, differences in skill, or a willingness to bypass operating standards among young workers (Jensen & Sinkule, 1988).

In an experiment to determine the safety system that would allow the highest production on a press, Katoh, et al. found a difference in hand speed between older and younger workers. They conducted a simulated press study using four males in their twenties and four males in their fifties. Younger subjects exhibited hand speeds faster than the OSHA constant using dual palm buttons. Both young and old subjects exceeded the OSHA hand speed constant when using presence sensing devices (PSD). Katoh, et al. recommended PSD safety devices for part revolution clutch equipment machines rather than two-hand palm switches to maximize loading speed and press production (Katoh et al., 2001).

3.7 Research Aim

Based on the literature, it is clear that the 1.6 m/s OSHA hand speed constant is not protective for all press operators. Multiple studies have found after-reach speeds that exceed the 1.6 m/s value and that hand speeds vary significantly between subjects and based on palm button placement and orientation (e.g. shoulder height versus waist height).

While there may be no hand speed constant in the sense that OSHA uses it in the safe distance” equation, it is possible to develop a maximum after-reach speed based on the two button locations typically found in presses. This maximum can be found by sampling the press operating population and determining the 95th percentile hand speed of the sample (as an estimator for the population). The 95th percentile value is an important number, since this value is typically considered a compromise between protection and practicality for regulators (Jensen, 2017) .

Jensen used the 95th percentile concept to reinterpret the hand speed data developed by Pizatella and Moll and to recommend a hand speed 2.14 m/s for upper button placement and 1.88 m/s for lower button placement. These values are based on the total 60 subject sample (male and female, age 20-60 years old). A more conservative approach would be to sample the press operating population most at risk (those with the fastest hand speed) and determining the 95th percentile hand speed of that population. Based on the work of Pizatella and Moll, a hand speed constant based on younger workers (20-30 years of age) should represent the maximum hand speed of the worker population at large. (Pizatella & Moll, 1987)

3.8 Equipment

To determine hand speed, the present experiment used optical motion tracking (Vicon, Oxford, 14 Minns Business Park, West Way, Oxford England, OX2 0JB) to capture the hand velocity of subjects performing an after-reach movement. Vicon is a more sophisticated system than has previously been used for after-reach tracking, since it captures not only the start and stop times of the hand motion, which allows the calculation of average velocity through the motion, but also captures the path of the subject's hand which allows the calculation of velocity and acceleration throughout the motion.

All of the after-reach measurements in the literature were collected using some form of simulated press. The most sophisticated simulator was built by Pizatella and Moll for their study and later used by both Horton and Jensen for their studies. Pizatella's simulator included a reciprocating ram, waist/shoulder height dual palm button stations, photo-optic sensor for speed sensors, simulated work pieces, and a mechanism to kick work pieces from the die and initiate an after-reach event. The construction of a fixture, which duplicated the geometry of the simulator built by Pizatella, was fabricated and used for the present study.

The apparatus for this experiment included simulated two-hand start buttons (56 cm apart) at waist height (84 cm from the floor) and shoulder height (160 cm from the floor) with a near waist height after-reach target (107 cm from the floor). These dimensions not only mimicked Pizatella's simulator, but were also similar in geometry to the typical free standing, C frame press being built today (based on a review of the catalogues of six different press manufacturers). The apparatus was constructed of wood and counterweighted to prevent tipping, with all sharp

edges padded to prevent injury. The press was painted flat black to minimize reflectivity that might interfere with the optical motion capture system (Figure 3.3).

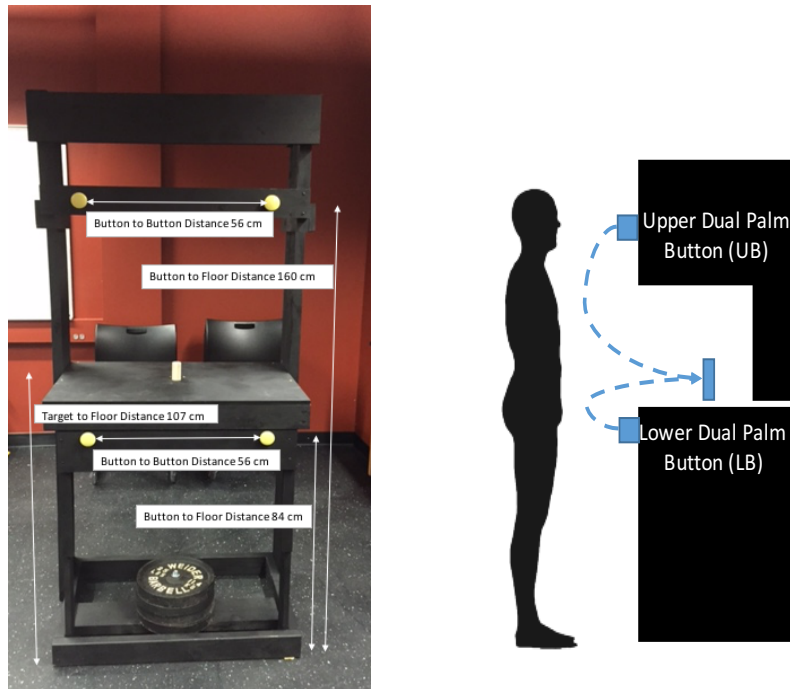

Figure 3.3: Waist Height and Shoulder Height Dual Palm Button Layout

Optical motion capture (OMC) systems use multiple cameras to triangulate the position of reflective markers attached to the subject (Figure 3.4). OMC is accurate (system error is less than 2 mm (Merriaux, Dupuis, Boutteau, Vasseur, & Savatier, 2017)) and is considered the gold standard for segmental kinematic measurements (Ceseracciu, Sawacha, & Cobelli, 2014). The OMC system used to collect the hand speed data for this experiment used seven (7) Vicon T010 cameras and the motion capture data was processed using Xsens MVN Studio BIOMECH Version 4.2.0 software.



Figure 3.4: Layout of the Reflective Markers Used to Identify Kinematic Segments

3.9 Subjects

IRB approval was obtained before the experiment began and all research subjects provided informed consent. The criteria for experimental subjects were to be 19 to 30 years old, with no history of heart disease, stroke or breathing disorder that prevented exercise, and no medical history or injury to their back, shoulders, arms or hands that would prevent rapid movement. The experiment was conducted using thirty (30) male subjects and thirty (30) female subjects. The male subjects ranged in age from 20 to 29 years with an average age of 24 years old. The female subjects ranged in age from 19 to 30 years with an average age of 23.5 years old.

On the day of the experiment, the subjects were interviewed to insure they met the requirements of the study, they reviewed the experimental procedure, and signed a voluntary consent form. After signing the consent, the subject's measurements were taken (height and length measurements of their arms, legs, and arm reach). Vicon reflective markers were then placed on the subject's shoulder, elbow, wrist, and fingertip of their dominant hand. Only right hand dominant subjects were used in this experiment.

The experiment was a randomized design with order of the trials decided based on a coin flip. The trial plan was explained to the test subject and the subject was asked to practice each movement until they felt comfortable with it before the actual measurement was taken. They were instructed to reach for the target with their dominant hand. The subject was given a "one-two-three-go" signal and then asked to make a rapid hand movement from the fixed starting position to the target position. The movement was repeated three times. After completing the three trials, the researcher explained the next start position, the subject was allowed to practice, and the next trial was performed.

3.10 Results of the Experiment

The experiment consisted of two elements: reaching from the lower dual palm button (LB) location to the target (Figure 3.5) and reaching from the upper dual palm button (UB) location to the target of a simulated press. Each subject was asked to repeat the LB/UB trial three times.



Figure 3.5: Subject at the Simulated Press at the Upper Dual Palm Button (UB)

Each trial generated a set of Vicon data which contained position data and a frame count. The Vicon was set at 120 frames/second. A Python program (Version 2.7) was used to extract the average velocity of the movement of the fingertip reflector over the path traveled from the dual palm button to the target based on a selected start point and endpoint. The hand speed was assumed to be the velocity of the fingertip reflector during the motion.

An analysis of variance (ANOVA) was run on each data set (Male LB, Female LB, Male UB, and Female UB). Each trial run was considered a treatment and analyzed against a null hypothesis (H_0) of all means being equal. If this hypothesis was rejected (H_1 = at least one mean is different), then it would mean the trials were different run to run. For example, if the means were increasing from trial to trial, it could mean that the subjects were learning and improving their after-reach skill during the experiment; if the means were decreasing run to run, fatigue

could be an issue. The results of the ANOVA were p_{value} Male LB=0.9103, p_{value} Female LB=0.7789, p_{value} Male UB=0.2397, and p_{value} Female UB= 0.1958. The test failed to reject the null hypothesis for any of the trials, so each of the three experimental runs were considered independent trial runs. To aid in data handling, the trials were averaged and calculations reported based on the average of the three trials.

For the reach from the lower button (LB) to the target, the thirty male subjects and thirty female subjects generated sixty (60) data sets. Fifty-six (56) of these data sets could be read and analyzed by the Python program. An analysis of the trials using Minitab found:

- a) The male mean hand speed for the LB position was 1.24 m/s with a standard deviation of 0.17 m/s. The range for the sample was 0.95 m/s to 1.93 m/s.
- b) The female mean hand speed for the LB position was 1.26 m/s with a standard deviation of 0.21 m/s. The range for the sample was 0.88 m/s to 1.65 m/s.

Using Minitab to develop box plots of the data revealed that one of the male subjects was an outlier (greater than 1.5 IQR from the third quartile). This subject was removed from the data since outliers skew the statistics and normality on small data sets. After removing the outlier, the male mean hand speed for the LB sample was 1.22 m/s with a standard deviation of 0.10 m/s and a range of 0.95 m/s to 1.45 m/s.

The hand speed reached by subjects for the upper button trials was significantly higher than the lower button experiment. For the reach from the upper button (UB) to the target, the thirty male subjects and thirty female subjects generated sixty (60) data sets. Fifty-eight (58) of these data

sets could be read and analyzed by the Python program. An analysis of the trials using Minitab found:

- a) The male mean hand speed for the UB position was 2.23 m/s with a standard deviation of 0.43m/s. The range for the sample was 1.37 m/s to 3.56 m/s.
- b) The female mean hand speed for the UB position was 2.18 m/s with a standard deviation of 0.43 m/s. The range for the sample was 1.55 m/s to 3.21 m/s.

Using Minitab to develop box plots of the data revealed that one of the male subjects was an outlier (greater than 1.5 IQR from the third quartile). Accordingly, this data point was removed from the data. After removing the outlier, the male mean for the UB sample was 2.19 m/s with a standard deviation of 0.35 m/s.

To further analyze the data, a split plot ANOVA was developed using Statistx 8.0 (Table 3.1). The ANOVA summarized the hand speed data with gender as a between subjects variable and button position (UB versus LB) as a within subjects variable. The ANOVA comparing the means of male and female hand speed from the UB and LB position (H_0 = means are equal) found no significant difference between males and females (failed to reject H_0 , at $p_{\text{value}}=0.3742$) for this study. The ANOVA compared the means of hand speed (H_0 = means are equal) between the LB and UB buttons and found a significant difference between LB and UB trials (reject H_0 , $p_{\text{value}}, <0.0000$) for this study.

Table 3.1: Hand Speed ANOVA with Gender as a Between Subjects Variable and Button Position (UB versus LB) as a Within Subjects Variable

Source	DF	SS	MS	F	p
Gender	1	0.1286	0.1286	0.81	0.3742
Error: Gender*Subject	34	5.3932	0.1586		
Button	1	24.7743	24.7743	405.67	0.0000
Gender*Button	1	0.0116	0.0116	0.1900	0.6646
Error: Gender*Subject*Button	74	4.5192	0.0611		
Total	111				

Evaluating the UB and LB data set using the Anderson-Darling Normality Test in Minitab (H_0 = data follows a normal distribution) found for the LB distribution $p_{value}= 0.2470$, and for the UB distribution $p_{value}= 0.6333$. At these p_{values} , we would not reject H_0 and so the LB and UB hand speed follow a normal distribution. Since both sets of the data are normal, it is possible to construct percentile tables (Table 3.2) based on the mean and standard deviation of the samples.

Table 3.2: Percentile Values and Corresponding After-reach Speeds

For LB and UB Positions

Population Percentage	Lower Button Estimated Hand Speed	Upper Button Estimated Hand Speed
10 th	1.03	1.68
20 th	1.10	1.86
30 th	1.16	1.98
40 th	1.20	2.09
50 th	1.24	2.18
60 th	1.28	2.28
70 th	1.33	2.39
80 th	1.39	2.51
90 th	1.45	2.68
95 th	1.51	2.83

3.11 Discussion of Results

The purpose of this study was to measure hand speed of younger workers (20-30 years of age), which based on the work of Pizatella and Moll (Pizatella & Moll, 1987), should represent the maximum hand speed of the working population, and compare it to the OSHA hand speed constant (1.6 m/s). If hand speed of younger workers is greater than 1.6 m/s, it could mean that OSHA's standard may not be conservative enough to protect some operators in power press applications. Traditionally, researchers have reported their results based on the maximum hand speed generated by their test subjects during the after-reach trials. This experiment was conducted with thirty (30) male and thirty (30) female subjects with the intent of developing a normal distribution of the sample and estimating the hand speed of the 95th percentile for both the male and the female population. As Jensen noted, standard-setting bodies often consider the "percentage of protected workers" when setting standards. Typically standards are set to protect 95% of the working population as a compromise between "protection and practicality" since the cost of protecting 100% of the population can be very high (Jensen, 2017). For the reach from the lower palm buttons to the target, the 95th percentile hand speed for the sample population would be 1.51 m/s. Based on this experiment the OSHA constant would be protective for over 95% of the population. This value is lower than the estimates of the studies produced by others and represent the differences in the test fixture and the use of the average hand speed as opposed to the maximum hand speed for the calculations. Repeating the calculations using the maximum hand speed of the males and females would give a mean after-reach speed of 1.32 m/s with a standard deviation of 0.18 m/s; with these values the 95th percentile hand speed for the sample population would be 1.61 m/s. Under these conditions, the OSHA constant would protect about 94% of the population.

Table 3.3: Summary of LB Hand Speed, Various Studies

Study	Estimated Hand Speed, m/s	Basis/ Comment
Present Study Results Based on All Trials	1.510 m/s	Age 20-30, 95 th percentile hand speed based on the average of three trials for the sample population, n=58
	1.610 m/s	Age 20-30, 95 th percentile hand speed for the maximum of three trials, n=58
Pizatella and Moll (Pizatella & Moll, 1987)	1.34 m/s	Age 20-60, mean based on fastest of four trials, n=60
	1.75 m/s	Age 20-30, mean based on fastest of four trials, n=38
Jensen and Stobbe (Jensen & Stobbe, 2016)	2.24 m/s	Age 20-30, mean based on the fastest of four trials, n=9
Horton (Horton et al., 1986)	1.74 m/s	Not older than 40 years old, mean based on fastest of four trials, n=10
Jensen (Jensen, 2017)	1.877 m/s	95 th percentile based on data drawn from Pizatella & Moll, age 20-60, mean based on four trials, n=60

For the reach from the Upper Buttons to the target, the 95th percentile hand speed for the sample population would be 2.83 m/s. Based on this experiment the OSHA hand speed constant would protect less than 10% of the population. Repeating the calculations using the maximum hand speed of the males and females would give a mean after-reach speed of 2.34 m/s with a standard deviation of 0.44 m/s; with these values, the 95th percentile hand speed for the sample would be 3.12 m/s. Based on the results of this experiment, the OSHA hand speed constant is un-protective of press workers 20-30 years old using shoulder height dual palm buttons. A comparison of the present study and previous studies for UB and LB hand-speed is provided in Table 3.3 and 3.4.

Table 3.4: Summary of UB Hand Speed, Various Studies

Study	Estimated Hand Speed, m/s	Basis/ Comment
Present Study Results Based on the Average of All Trials	2.825 m/s	Age 20-30, 95 th percentile hand speed based on three trials for the sample population, n= 58
	3.120 m/s	Age 20-30, 95 th percentile hand speed for the maximum of three trials, n= 58
Pizatella and Moll (Pizatella & Moll, 1987)	1.34 m/s	Age 20-60, mean based on fastest of four trials, n=60
	2.18 m/s	Age 20-30, mean based on fastest of four trials, n=38
Jensen and Stobbe (Jensen & Stobbe, 2016)	1.59 m/s	Age 20-30, mean based on the fastest of four trials, n= 9
Horton (Horton et al., 1986)	2.16 m/s	Not older than 40 years old, mean based on fastest of four trials, n=10
Jensen (Jensen, 2017)	2.401 m/s	95 th percentile based on data generated by Pizatella & Moll, age 20-60, mean based on four trials, n=60

Pizatella (Pizatella & Moll, 1987), Jensen (Jensen, 1989), and Horton (Horton et al., 1986) all found significant differences in after-reach speed between button positions. Jensen maintained that hand speed is not a constant as assumed in the OSHA standards, because of this difference. An ANOVA of Lower Button Hand Speeds versus Upper Button Hand Speeds using the data from the present study found similar results. The null hypotheses that the UB and LB hand speeds are equal ($H_0 = \text{means are equal}$) was rejected with a p_{value} of less than 0.0001. Pizatella and Moll theorized that the difference in hand speed between LB and UB was due to the “change in direction” required to disengage from the lower button. They noted “This change of the direction appears to have a considerable influence on the speed with which the hand can travel in an after-reach situation”(Pizatella & Moll, 1987).

A review of the Vicon tracks generated by this study support this theory. When the operator presses the lower button, he/she is required to assume a supinated wrist position. To disengage from the button, the operator's hand must move backwards and then begin the motion toward the target. This backward movement can be seen on the Vicon track as well as a "looping" hand movement required for the operator to reach over the bolster to the target (Figure 3.6). The hand movement required for the operator to reach over the bolster to the target (Figure 3.6). The hand movement from the upper button begins from a pronated wrist position and does not require a backward movement (Figure 3.7). It is also a more direct and gravity assisted movement.

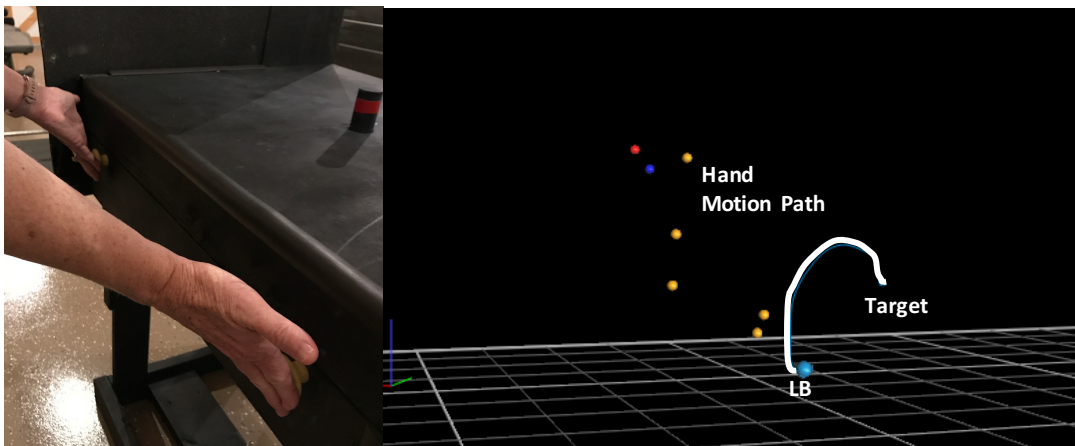

Figure 3.6: Hand Orientation at LB Position and Vicon Track of LB to Target

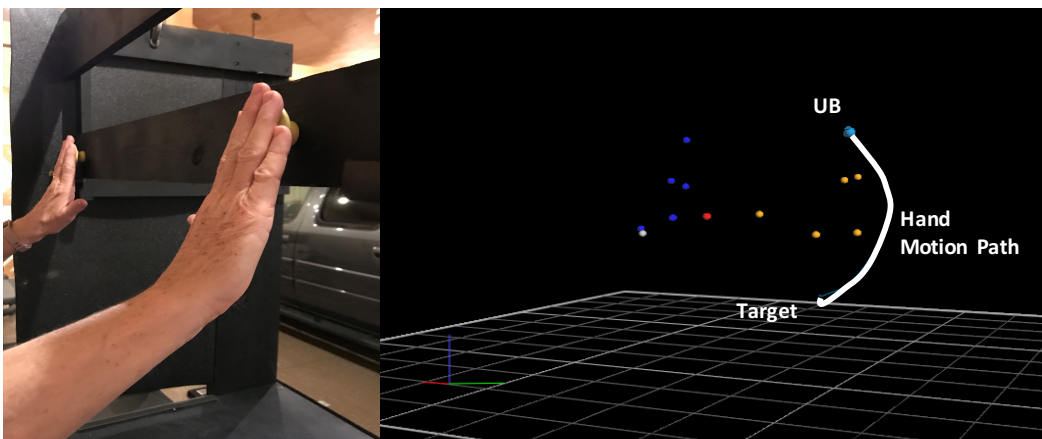

Figure 3.7: Hand Orientation at UB Position and Vicon Track of UB to Target

A ballistic movement (which generates the fastest hand-speed) consists of a rapid hand or foot motion that is “triggered automatically” and “is carried out without any form of feedback monitoring once it is initiated” (Flowers, 1975). A ballistic movement consists of “an initial impulse accelerating the hand/foot toward the target, followed by a decelerating impulse to stop the movement. There is no mid-course correction.” (Prasad, Kellokumpu, & Davis, 2006). A plot of the hand speed data from the UB and LB positions show the impact of the reorientation on hand speed (Figure 3.8). The plot shows that, from the LB position, the hand has a distinct acceleration/deceleration as it moves back from the button and reorients and then a second acceleration/deceleration movement as it moves toward the target. The movement from the UB position is a typical ballistic movement without a mid-course correction.

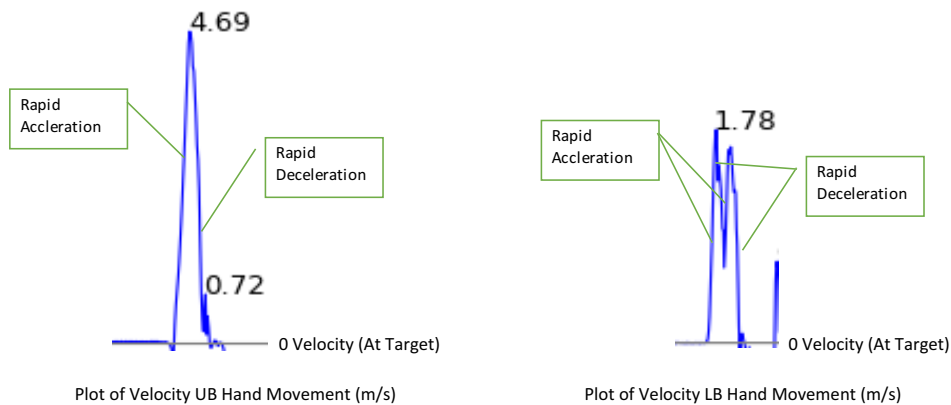

Figure 3.8: Velocity of Movement from UB & LB Position to Target

The ergonomic hurdle of disengaging from the supinated wrist position (which prevents a true ballistic movement) is at least part of the speed difference between LB and UB hand speeds. This is an area for future research. The setback distance (or safe distance) for dual palm buttons is a balance between safety (preventing after-reach injury) and machine productivity. Smaller

setback distances increase machine productivity by reducing machine loading/unloading time. If engineers better understand the ergonomic hurdle in the LB position, it could be applied to other palm button positions to minimize the setback requirement.

Pizatella and Moll found significant differences in mean hand speed between genders. (Pizatella & Moll, 1987) Since their work is considered the benchmark for after-reach measurement, it is often stated in the literature that male operators have faster hand speeds than females. In the present study, with subjects between 20-30 years old, no significant difference was found between genders for the LB or UB position (failed to reject H_0 , at $p_{\text{value}}=0.3742$). Pizatella's sample of females, 20-30 years old, was a small portion of his study ($n=7$ out of 60). Horton [five (5) male subjects and five (5) female subjects] did not see a statistically significant difference in gender hand speed. (Horton et al., 1986) Based on Horton's work and the present study, the assumption that females have slower hand speeds than males is suspect and should not be assumed when developing set back distances for subjects between 20-30 years old.

3.12 Conclusions

Operator after-reach speed (and hence palm button set back distance for presses) remains a complex issue. Multiple studies have found differences in after-reach speed from the LB/UB locations. For this study, the 95th percentile hand speed for the reach from the lower buttons was 1.51 m/s; the OSHA constant would be protective for over 95% of those tested at the LP position. For the reach from the upper buttons, the 95th percentile hand speed was 2.83 m/s, and the OSHA constant would protect less than 10% of those tested. The study found that the hand speed between the UB and LB positions is significantly different, which implies that the use of a

single hand speed constant for both locations is inappropriate. The present study, casts doubts on the assumption that females have slower hand speeds than males for workers between 20-30 years old.

Chapter 4

Evaluating Hand Speed in Automated Systems using Presence Sensing Devices

4.1 Abstract

The Occupational Safety and Health Administration (OSHA) uses 1.6 m/s as the hand speed constant for setting the safe distances for light curtains and other presence sensing devices. This constant is based on research conducted by Löbl in 1935, who used a fixed hand starting position to estimate the maximum human hand speed at this value. The present study used thirty (30) male and thirty (30) female subjects (age 20-30 years old) to develop a normal distribution and estimate the 95th percentile hand speed for both the male and female populations in a simulated Presence Sensing Device (PSD) based system. Results indicated that a hand speed constant between 3.55 m/s to 3.85 m/s would protect 95% of a population age 20–30 years old. The current OSHA hand speed constant of 1.6 m/s is not protective of this population. OSHA should consider revising its hand speed constant and affected standards to better protect young workers from known and prevalent guarding hazards involving PSDs and robotics applications.

4.2 Introduction

Stamping presses are one of the earliest machine tools and intended to trim, blank, or pierce sheet metal using a die designed to create the shape of the part required (Cattell, 2008). Early presses were mechanical (powered by a driven flywheel) and were manually loaded and unloaded. Manual feeding makes presses dangerous to operate, since loading/unloading the machine places the operator's hand(s) into the point-of-operation formed when the upper and lower dies close during the press stroke. In 1935, in one of the earliest machine safety research efforts, Oksar Löbl investigated the distance start levers should be placed from the point-of-operation to prevent amputation due to an after-reach error (Lobl, 1935). After-reach occurs when a worker attempts to reach into the press after the downward cycle of the press has been actuated. This is believed to be an inadvertent, automatic response to clear a process upset in the die (NIOSH, 1987).

In Löbl's day, before the advent of electro-mechanical controls, operators actuated mechanical levers to engage the flywheel on a full revolution clutch and began the downward stroke of the die. No standards were available to determine how far away the start levers should be placed to prevent an operator from committing an after-reach error once they had initiated the cycle of the press. Löbl designed an experiment to measure the time it took subjects to push the start levers of the press, release the levers, and move their hand until they touched a "target plate" in a simulated stamping press. Löbl calculated hand speed based using the elapsed time over the distance the hand traveled. His calculated value of 1.58 m/s was the maximum speed attained by one of his test subjects during the experiment, and based on this data point he estimated (rounded up) that the maximum hand speed a human could obtain was 1.6 m/s. (Lobl, 1935).

4.3 Stamping Presses and Hand Speed

Articles began to appear in the literature by 1909 which examined safety improvements to presses and the first consensus safety standard, written by the American Standards Association (the forerunner of the American National Standard Institute (ANSI)), was issued in 1926 (Fuller, 1993). OSHA was aware of the hazards associated with power presses and issued press safety standards in 1972.

The regulations OSHA developed were based on ANSI B11.1-1971. (Baldwin, 1976) ANSI required the use of point-of-operation devices which prevented or stopped the stroke of the press if “the operator’s hands are inadvertently placed in the point-of-operation” (ANSI B11.1-1971 5.3(1)). Point-of-operation devices include fixed guards, PSDs, pullback devices, sweeps, two hand trips, and two hand control devices. They did not provide any guidance on the safe distance for the two hand controls or for PSDs, and stated only that their location must be far enough away that the press would complete its stroke before the operator’s hands could reach into the die (ANSI, 1971). The ANSI committee also recommended that all presses be updated so “presswork should no longer require workers’ hands in the hazardous die area” (Baldwin, 1976).

The standard OSHA issued in 1972 (1910.217) included all of the ANSI B11.1-1971 recommendations, including the controversial “no hands in die” requirement. This was a major concern for press users and they petitioned OSHA to revise 1910.217 because of the burden it imposed on industry. In 1974 OSHA modified 1910.217 to allow “hands in die” loading, but they also included changes to improve machine control reliability and point-of-operation

safeguarding (Baldwin, 1976). Manually loading a press increases the risk of amputation because it requires operators to place their hands into the “pinch point” generated by closing the die. In addition to preventing an operator from actuating a press with his/her hands, the use of pullbacks, two hand palm buttons or light curtains (Figure 4.1) are used to minimize after-reach errors.

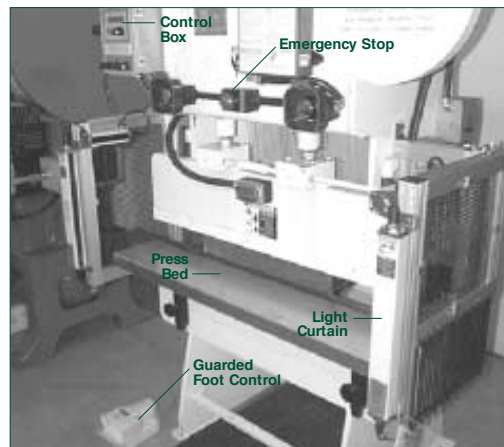

Figure 4.1: Typical Press with Presence Sensing Device (Light Curtain)

Taken from “Safeguarding Equipment and Protecting Employees from Amputations”

OSHA 3170-02R 2007 (OSHA, 2007)

4.4 Calculating Safe Distance and Concerns with the Hand Speed Constant

The distance the dual palm start buttons are positioned from the point-of-operation is called the safe distance or setback distance. To reduce the after-reach hazard, a minimum safety distance between the point-of-operation and the safety device is required so that operators cannot release the dual palm buttons or reach through the light curtain before the press closes. According to OSHA, the setback distance is calculated using Equation 4.1:

$$D(s) = 63 \text{ inches/second} * T(s) \quad \text{Equation (4.1).}$$

Where $D(s)$ is the safe distance and $T(s)$ is hazard time or press closing time. Per the OSHA standards, 63 inches/second (or 1.6 m/s) is the hand speed constant, which represents the speed at which workers can perform an after-reach movement.

OSHA 1910.217(c)(3)(vii)(c) mandates the use of 63 inches/sec (1.6 m/s) constant to calculate the safe distance (setback distance) for dual palm buttons on presses and light curtains. (OSHA 1910.217, 2013) OSHA's 63 inch/sec (1.6 m/s) hand speed constant is based on the original hand speed research conducted by Löbl in 1935 (OSHA Etool Website, 2017). In the 1980's, the National Institute for Occupational Safety and Health (NIOSH) researchers began examining press safety and reexamining Löbl's conclusions on safe distance. Several studies found that hand speed was not a constant and varied based on the placement of the dual palm buttons (upper and lower locations) (Pizatella, Etherton, Jensen, & Oppold, 1983), (Jensen & Pizatella, 1986)

In 1987 Pizatella and Moll published a definitive study on safe distance and after-reach speed. The experiment used 60 subjects (of various ages) all of whom were industrial workers and 85% whom had previously worked on power presses. They found significant inter-subject differences in hand-speed based on age and gender. The location of the subject's start position (waist level vs shoulder level) also influenced speed; start position at shoulder height allowed workers to generate 15% faster hand speeds than the waist height start position. (Pizatella & Moll, 1987)

In 1986 Horton et al. published the results of a study using five male and five female subjects to evaluate the after-reach speed at the three most common dual palm button positions and button orientation(s) (shoulder level-vertical, waist level-vertical, and waist level-horizontal). Their subjects demonstrated the fastest after-reach speed at the waist level-horizontal button location

(2.13 ± 1.03 m/s). Horton noted that the 1.6 m/s hand speed constant was not conservative enough to protect all operators and that the position of the hands at the start of the after-reach movement had a significant impact on after-reach speed. (Horton, Pizatella, & Plummer, 1986).

In 1989 as part of his dissertation, Jensen investigated the impact of palm button placement on after-reach speed. Jensen's hypothesis was that hand speed was not a constant and was impacted by both button placement (shoulder height or waist height) and distance from the palm buttons to the point-of-operation. His subjects averaged 1.59 m/s in the lower button placement and 2.24 m/s in the upper button placement. He recommended abandoning the "hand speed constant" concept in favor of a speed formula based on experimental data (Jensen & Stobbe, 2016) (Jensen, 1989).

In March 1987, in response to the evidence amassed by research scientists (Pizatella, Moll, Horton, Jensen and others), NIOSH issued Current Intelligence Bulletin (CIB) 49 and warned employers they believed the OSHA hand speed constant was not protective for all workers and that additional safety precautions were necessary for some workers. NIOSH stated, "It may be impractical to implement a single hand-speed constant which would protect all workers under all power press set-ups. Implementation of such a hand-speed standard would render dual palm buttons practically useless as a safeguarding device due to the long safety distances which would result" (NIOSH, 1987)

CIB 49 did not address the use of the 63 inches/sec (1.6 m/s) constant to calculate the safe distance for presence sensing devices (OSHA 1910.217(c)(3)(iii)(e)) (NIOSH, 1987).

4.5 Presses and Light Curtains

The first electronic presence sensing device was the light curtain. The light curtain was developed in 1952 by Erwin Sick, a German optical engineer, who used the principle of auto-collimation to develop a photoelectric switch. (SICK AG, 2017) Sick's innovation was a boon to press safety since it allowed the guarding of the point-of-operation without obscuring its view or adding an ergonomic barrier to part loading/unloading.

ANSI recognized the value of presence sensing devices to press safety and included them in the B11.1 standard as an acceptable point-of-operation guarding method. ANSI B11.1-1971 2.8.1 defines a presence sensing device as “a device designed, constructed, and arranged to create a sensing field or area and to deactivate the clutch control of the press when an operator's hands or any other part of his body is within such field or area.” (ANSI, 1971) If a light curtain was used on a press, ANSI B11.1-1971 required the PSD to be interlocked into the press's clutch and brake controls and to release the clutch and apply the brakes if “an operator's hands or any other part of his body is detected in the sensing field of the device.” The PSD could not create any hazard to the operator, could not be used on a full revolution press, could not be used as a tripping (cycle start) device, and must be failsafe (ANSI B11.1-1971 5.3.2.).

ANSI B11.1-1971 did not provide a method for calculating a safe distance for the PSDs. As a part of the 1974 revision of 1910.217(c)(3)(iii)(e), OSHA applied the same hand speed constant and set back distance calculation to presence sensing devices. ANSI reissued B11.1 in 1982 and

mirrored OSHA's formula for safe distance calculations, but included comments in B11.-1982

5.3.2(5) which noted:

“The 63 inch/second figure is derived from the OSHA (1974) regulations. Under certain circumstances a higher hand speed may be necessary. Small parts in conjunction with fast operator speed should be viewed with particular concern”(ANSI, 1982).

As previously discussed, several research studies have been undertaken to evaluate OSHA's hand speed constant in relation to the safe distance calculation for dual palm buttons in press applications. Similar research has been undertaken in regard to the hand speed constant when used to calculate the setback distance for light curtains.

In 1981 Davies & Mebarki conducted research into the hand speed of “press brakes utilizing photo-electric safety devices.” Their original study aim was to compare the hand speed of operators standing and sitting. Their subject pool consisted of thirty-six (36) males 16-56 years old and sixteen females 16-50 years old. They found a significant difference in male versus female hand speed and old versus young hand speed. Davies & Mebarki were concerned about the hand speeds generated by young males and suggested that “the young male group is at risk when operating press guards fitted with photo-electric safety devices” even if the press met the British safety standards (Davies & Mebarki, 1983).

In an experiment to determine the safety system that would allow the highest production on a press, Katoh, et. al compared the production rate of a press equipped with dual palm buttons versus a press equipment with a light curtain. They conducted the comparison study using four

males in their twenties and four males in their fifties. Younger subjects exhibited hand speeds faster than the OSHA constant using dual palm buttons. Both young and old subjects exceeded the OSHA's 1.6 m/s hand speed constant when using presence sensing devices to initiate the machine cycle. Katoh, et al. recommended PSDs safety devices for part revolution clutch equipment machines rather than two hand palm switches to maximize loading speed and press production (Katoh et al., 2001).

OSHA has not updated the safe distance calculation of PSD developed in 1974 to address the concerns NIOSH has expressed about the 1.6 m/s constant, but ANSI has attempted to address this by strengthening their safe distance formula (ANSI B11.1-2009, E8.63.16).

4.6 Robots and Hand Speed

While presses are one of the oldest manufacturing systems, robotic manufacturing systems are one of the newest. The International Federation of Robotics estimates that the number of robot systems increases approximately 15% per year and that by 2019 there will be more than 1.4 million industrial robots installed in factories around the world. (Gemma, 2017)

The first safety standard in the United States for robotic systems was developed by the Robotic Industries Association (RIA) in 1992. The standard, later adopted by ANSI, was titled ANSI/RIA R15.06-1992 American National Standard for Industrial Robots and Robot Systems Safety Requirements. OSHA provides some guidance on robot safety (STD 01-12-002 Guidelines For Robotics Safety (OSHA, 1987) and the OSHA Technical Manual Section IV: Chapter 4: Industrial Robots and Robot System Safety (OSHA, 1999)), but generally regulates robot cells

under the general duty clause and references ANSI/RIA R15.06 as a best practice and consensus standard.

ANSI/RIA R15.06-1999 3.22 identifies the operator as “The person designated to start, monitor and stop the intended operation of a robot or robot system. An operator may also interface with a robot for production purposes.” The RIA standard requires that the operator be protected when they interact with the robot (“such as feeding parts to the robot”) and safeguarded while any part of his/her body is within the robot’s active space. While OSHA’s and ANSI B11.1 have remained static on the hand-speed constant used for light curtain set back, the ANSI/RIA standards have evolved to be more protective and in harmony with global safe distance calculations.

Machine tools and industrial robots represent very different safety challenges. Machine tools are relatively stationary with limited degrees of motion freedom; robots typically have four (4) to six (6) degrees of freedom and have a large working envelope. As noted by Jiang, et al., “traditional machines, danger usually occurs at the point of operation, such as cutting, shaping, or forming of the material. With industrial robots, accidents can take place at any point within the working envelope of a robot and sometimes even outside the normal envelope” (Jiang, Lio, Suresh, & Cheng, 1991).

Operators are normally protected from the robot, by perimeter guarding. Entrance into the guarded area is made through interlocked gates to restrict access. (Strubhar, 1985) Parts must be loaded into the cell for the robot to process without exposing the operator to harm. Potter

recommends the use of rotary tables or shuttles to segregate the operator from the robot during part loading (Potter, 1983). However, this is not required by the ANSI/RIA R15.06, RIA allows the use of presence-sensing devices to protect the operator. Allowable PSDs include light curtains, area scanning devices, radio frequency devices, safety mat systems, single/multiple beam systems, and two hand controls (RIA15.06-1999, 11) (ANSI/RIA, 1999).

In 1999 ANSI/RIA used a version of the ANSI safe distance formula developed for PSD set-back for power presses (ANSI B11.1). This formula applied to the safe distance for light curtains, safety mats, and area scanners in robotic cells. The ANSI safe distance formula was:

$$D_s = K * (T_s + T_c + T_r) + D_{pf} \quad \text{Equation (4.2).}$$

Where D_s is the minimum safety distance between the safe guarding device and the hazard, K is a hand speed constant (1.6 m/s, “minimum based on the movement being the hand/arm only and the body being stationary”), T_s is the worst stopping time of the machine/equipment (sec), T_c is the worst stopping time of the control system, T_r is response time of the safeguarding device and D_{pf} is the sensitivity of the PSD as calculated from Figure B.2, Annex B of ANSI/RIA 15.06. ANSI noted, in reference to the hand speed constant, “A greater value may be required in specific applications and when body motion must also be considered” (ANSI/RIA, 1999).

RIA’s use of the 1.6 m/s hand speed constant for the PSD safe distance calculation was consistent with the OSHA’s standard, but was in conflict with European standards, which used a more conservative value (2.0 m/s). (Health and Safety Executive Great Britainn, 1999) In 2000, RIA partnered with ISO to develop a global robot safety standard which would comply with European safety requirements and would provide a consistent robot standard worldwide

(Rockwell Automation, 2015). The new standard was adopted as ISO 10218-1 and ISO 10218-2: 2011 in Europe, CSA-Z434-14 in Canada, and ANSI/RIA R15.06-2012 in the United States.

R15.06-2012 was a significant upgrade for RIA15.06-1999. The 2012 standard added Part 1: Industrial Robots (requirements for robot manufacturers) and Part 2: Industrial Robot Systems and Integrator (requirements for robot integrators and users). The standard was written to allow the application of “collaborative robots” (robots that share a workspace with a human). It changed robot clearance requirements to optimize robot cell size, allowed wireless pendants, changed the design standards for perimeter guarding, and so forth. The standard also changed robot terminology, required that all robot system design include a safety risk assessment and referenced ISO/IEC for many equipment and safety specifications (ANSI/RIA, 2012).

Light curtains, laser scanners, safe mats, and so forth were labeled “sensitive protective equipment.” The design of light curtains and laser scanners were required to comply with IEC 61491-1 (or UL 61496-1 for USA installations) and applications of the devices were required to meet IEC/TS 62046 (or ANSI/RIA TR R15.406 for USA installations). The formula for safe distance was removed from the standard and ISO 13855 was referenced:

“The formula in ISO 13855 shall be used to determine minimum distance from the hazard (danger zone) to the sensitive protective equipment from all directions of approach.”

((ANSI/RIA, 2012) (5.10.5.2))

ISO 13855 provides a more conservative approach to the safe distance calculation. ISO’s set back calculation is:

$$S = (K \times T) + C \quad \text{Equation (4.3).}$$

Where S is the safety distance, K is the approach speed of the body or parts of the body, T is the overall system stopping performance, and C is an additional distance based on intrusion towards the danger zone (ANSI/RIA, 2014). The standard indicates that 1.6 m/s (63 in/s) is a common hand speed value, but notes that it does not allow for other body movements which can affect approach speed. ISO recommends the use of K=1.6 m/s if the subject walks into the sensing field, but requires the use of K=2.0 m/s for the speed of a hand penetrating the sensing area of a PSD (SICK AG, 2014) (Keyance, 2017).

ISO considers 1.6 m/s the minimum acceptable value for hand speed in sensitive protective equipment design and is allowed only if the 2.0 m/s safe distance calculation generates an excessive set back distance (ANSI/RIA, 2014). As stated in RIA TR R15.406-2014 8.2 Note 2:

“Unless the machine specific standard has a specific K, ISO 13855 applies, which requires that the minimum (safe) distance is first calculated using a K = 2,000 mm/sec (79 in/sec). If the resulting minimum (safe) distance is greater than 500 mm (20 in), then a K of 1,600 mm/sec (63 in/sec) can be used to determine the minimum (safe) distance.”

4.7 Research Aim

In 1935, Löbl developed an experiment to determine the after-reach speed operators could achieve reaching from horizontally positioned start levers to the point-of-operation of a press. Löbl’s hand speed constant, developed for a narrow application, has been adopted by OSHA and applied to the safe distance calculation for dual palm buttons. OSHA has also propagated the 1.6 m/s constant to various PSD technologies including light curtains and safety mats (OSHA

1910.217, 2013). The constant's use in PSD applications seems especially inappropriate since the hand starting position can be unconstrained by either palm buttons or levers.

Based on the literature, it is clear that the 1.6 m/s OSHA hand speed constant is not protective for press operators for dual palm button systems. Studies by Davies and Mebarki and Katoh, et al. on hand speed with PSDs on presses calls into question the protective capacity of the 1.6 m/s hand speed constant for PSD applications. Studies by Pizatella, Horton, and Jensen, which found higher hand speed based on starting hand start position, are also a concern since the hands of operators who work on PSD equipped systems are unconstrained by start button positions.

The aim of this study was to collect hand speed data for a part loading station for a simulated automated cell to determine if it is affected by an operator's hand start position. Researchers have attempted to determine the after-reach speed for power press operators, but research into PSD systems has been limited. For presses, after-reach occurs when a worker attempts to reach into the machine after the downward cycle of the press has been actuated. This study will define a new term "over-reach" and investigate the impact on operators working on an automated system protected by a PSD. For this type of system, "over-reach" occurs when a subject attempts to reach through a light curtain into an automated cell after the machine cycle has been actuated.

Using the data from the study, we will develop the normal distributions of the sample and estimate the maximum hand speed of a 95th percentile subject for both male and female populations. Jensen noted that the 95th percentile is important to regulators since this value is typically considered a compromise between protection and practicality (Jensen, 2017). This

research will provide an insight into the maximum attainable hand speed an operator can achieve for an “over-reach” event in a PSD equipped automated system.

4.8 Equipment

To determine hand speed, the present experiment used optical motion tracking (Vicon, Oxford, 14 Minns Business Park, West Way, Oxford England, OX2 0JB) to capture the hand velocity of subjects performing an over-reach movement from an unconstrained (no dual palm button) start position to a target. Vicon is a sophisticated motion capture (MoCap) system that is able to capture the subject’s hand path throughout a motion, which allows the calculation of the hand’s average velocity, instantaneous velocity, and acceleration throughout the motion.

Most of the after-reach measurements in the literature were collected using some form of simulated press. The simulated presses included an after-reach target and dual palm buttons (as a start position). Since this study is intended to duplicate reaching into a light curtain, we built a test stand that allowed open access to the over-reach target. The apparatus duplicated the after-reach target height typically used on power press simulators (mid-target, 107 cm to the floor), but also included over-reach targets six (6) inches higher (high target, 122 cm to the floor) and six (6) inches lower (low target, 98 cm to the floor) than the normal 107 cm target height.

The apparatus was constructed of wood and counterweighted to prevent tipping, with sharp edges padded to prevent injury. It was painted flat black to minimize reflectivity that might interfere with the MoCap system (Figure 4.2)

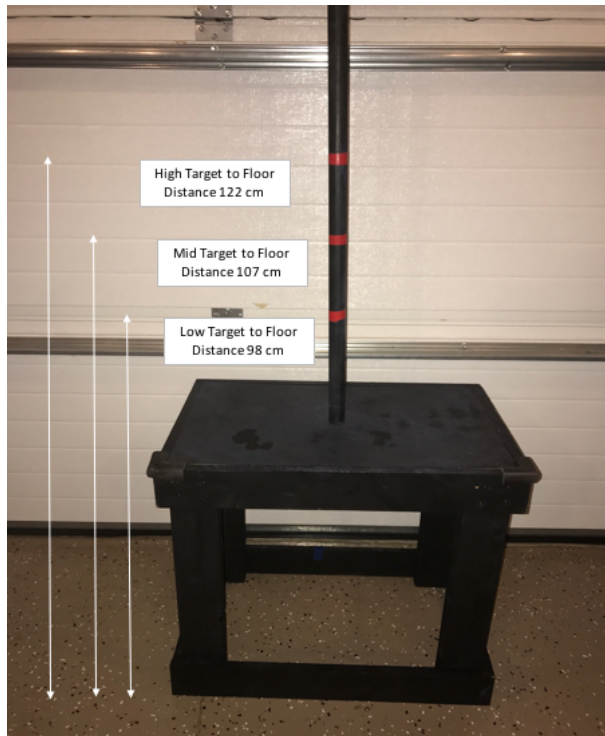

Figure 4.2: Free Hand After-reach Target

Optical motion capture (OMC) systems use multiple cameras to triangulate the position of reflective markers attached to the subject. OMC is accurate (system error is less than 2 mm) (Merriault, Dupuis, Boutteau, Vasseur, & Savatier, 2017). OMC is considered the gold standard for segmental kinematic measurements (Ceseracciu, Sawacha, & Cobelli, 2014). The OMC system used to collect the hand speed data for this study used seven (7) Vicon T010 cameras and the motion capture data was processed using Vicon Nexus 1.8.5 2013 software.

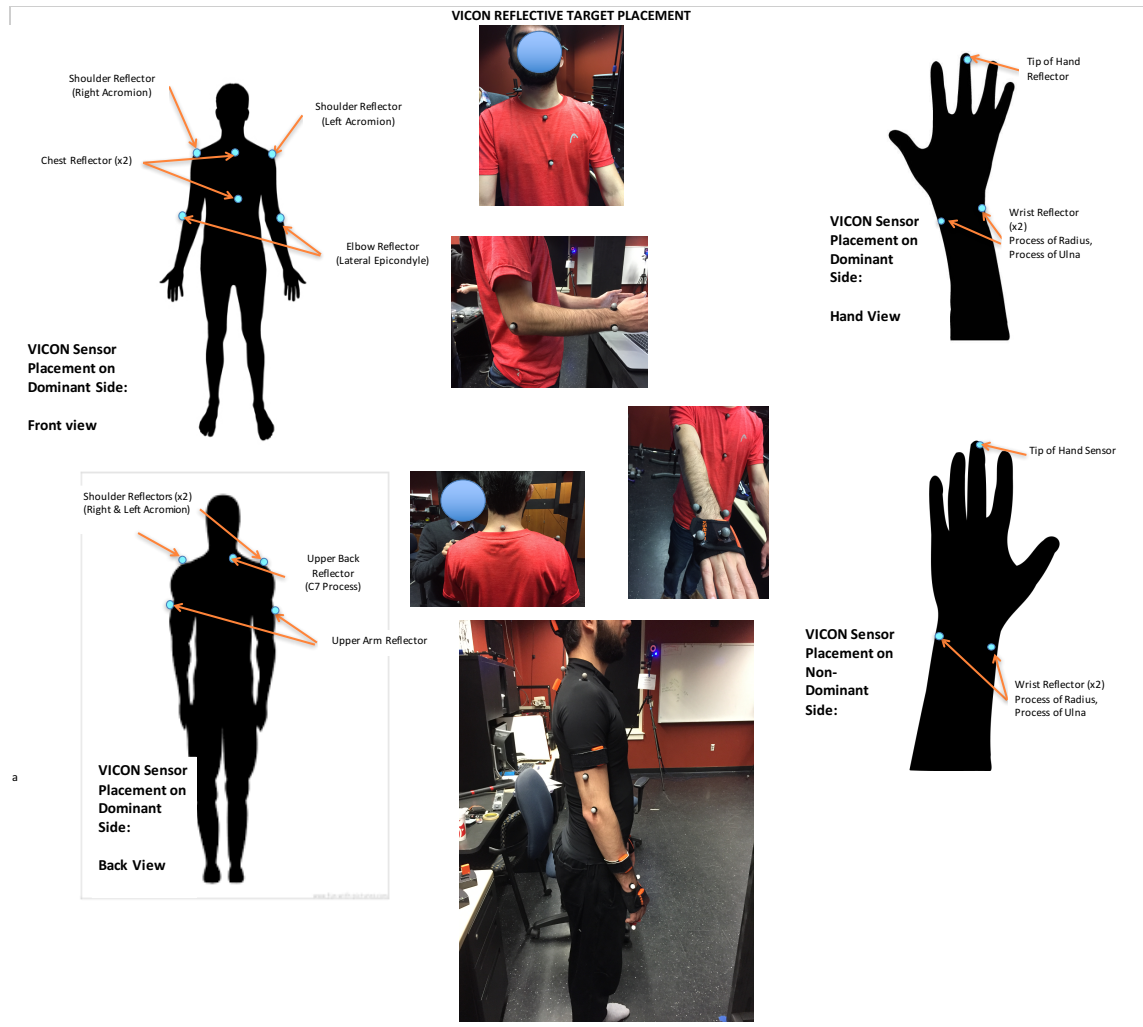

Figure 4.3: Layout of the Reflective Markers Used to Identify Kinematic Segments

Silhouette Images Taken from: <http://clipart-library.com>

4.9 Experimental Process

IRB approval was obtained before the study began and all subjects provided informed consent.

The criteria for experimental subjects were to be 19 to 30 years old, with no history of heart disease, stroke or breathing disorder that prevented exercise, and no medical history or injury to their back, shoulders, arms or hands that would prevent rapid movement. The experiment was conducted using thirty (30) male and thirty (30) female subjects. The male subjects ranged in age

from 20 to 29 years with an average age of 24 years old; the female subjects ranged in age from 19 to 30 years with an average age of 23.5 years old.

On the day of the trials, the subjects were interviewed (to insure they met the requirements of the study), they reviewed the experimental procedure, and signed a voluntary consent form. After signing the consent, the subject's measurements were taken (height and length measurements of their arms, legs, and arm reach). Vicon reflective markers were then placed on the subject's shoulder, elbow, wrist, and fingertips (Figure 4.3).

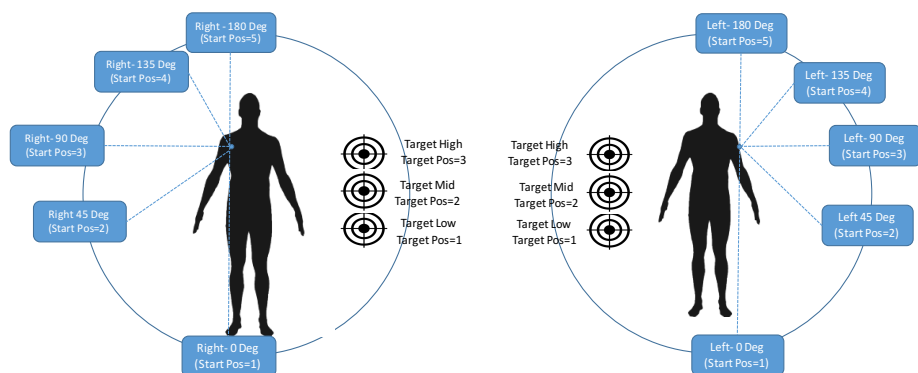

Figure 4.4: Layout of the Five (5) Start Locations and Three (3) Target Locations

Silhouette Images Taken from: <http://clipart-library.com>

For each subject the researcher gathered hand speed data from five (5) different start locations to three (3) target locations for their dominant (right) and non-dominant (left) hand (Figure 4.4).

The subjects repeated each movement from start position to target three (3) times. The initial hand start position was set using a goniometer to establish the correct arm angle. A marker (hung from the ceiling) was set at the subject's wrist to provide an origin for the initial trial and a reference starting point for the second and third trial. The subjects' finger tips were chalked so

that they left a witness mark on the over-reach target after each touch. A research associate confirmed a hit by observing the witness mark. Trials in which the subject did not touch the over-reach target were rejected. The trial was repeated until three consecutive hits were recorded.

The experiment was a split plot design employing a restricted randomization. The sequence of target heights (low, mid or high) and hand (right or left) was set using a six by six Latin square. Once a target height or hand was selected, all five start position trials were run. The order of start positions (arm angle 0° , 45° , 90° , 135° , and 180°) was randomized and were set using a five by five Latin square. Male subjects were tested in one block (subjects 1-30) and females were tested in a second block (subjects 31-60). Only right hand dominant subjects were used in the experiment.

To begin the experiment, the subject was assigned a start position, hand, and target position based on the randomization plan and asked to practice the movement until they felt comfortable with it. Subjects were allowed to control the distance they stood from the after-reach target. They were instructed to stand at a distance from the test stand that would allow them to achieve their maximum hand speed when they reached for the target. Once the subject had practiced the movement, they were given a “one-two-three-go” signal and asked to make a rapid hand movement from the starting position to the target position. The movement was repeated three times. After completing the three trials, the researcher explained the next start position, the subject was allowed to practice, and the next trial was performed.

4.10 Results of the Experiment

The experiment consisted of thirty elements (reaching from five start positions, to three target heights with two different hands) for each subject. The subject was asked to repeat each trial three (3) times which generated 5,400 experimental trials for the sixty (60) subjects. Each trial generated a set of Vicon data which contained position data and a frame count. The Vicon capture rate was set at 120 frames/second. A Python program (Version 2.7) was used to extract the average velocity of the movement of the fingertip reflector over the path traveled from the start position to the target based on a selected start point and end point. The hand speed was assumed to be the velocity of the fingertip reflector during the motion.

To aid in data handling, each set of three trials was averaged for each subject. All calculations were based on the average value of the three trials for each subject. The mean calculated for each hand and target position (segregated by gender) is shown in Table 4.1.

Table 4.1: Average Hand Speed by Gender, Target Position, Hand, & Start Position

Male Subjects (Gender=1)						Female Subjects (Gender=2)							
Target Position	Hand	Start Position	Arm Angle	N	Avg Hand Speed (m/s)	Std Dev (m/s)	Target Position	Hand	Start Position	Arm Angle	N	Avg Hand Speed (m/s)	Std Dev (m/s)
Low (TargetPos=1)	Left (Hand=1)	1	0	28	1.66	0.39	Low (TargetPos=1)	Left (Hand=1)	1	0	28	1.83	0.51
		2	45	30	2.64	0.49			2	45	30	2.48	0.64
		3	90	30	3.12	0.54			3	90	29	2.81	0.68
		4	135	28	3.14	0.43			4	135	30	2.83	0.57
		5	180	30	3.18	0.62			5	180	28	2.63	0.62
Mid (TargetPos=2)	Left (Hand=1)	1	0	29	2.07	0.38	Mid (TargetPos=2)	Left (Hand=1)	1	0	29	2.09	0.50
		2	45	30	2.68	0.43			2	45	30	2.58	0.67
		3	90	30	3.00	0.50			3	90	30	2.70	0.56
		4	135	30	3.11	0.52			4	135	29	2.80	0.63
		5	180	29	3.06	0.54			5	180	30	2.78	0.59
High (TargetPos=3)	Left (Hand=1)	1	0	30	2.29	0.44	High (TargetPos=3)	Left (Hand=1)	1	0	28	2.42	0.51
		2	45	28	2.70	0.49			2	45	29	2.46	0.51
		3	90	29	2.91	0.48			3	90	30	2.80	0.63
		4	135	30	2.95	0.65			4	135	30	2.49	0.75
		5	180	30	3.03	0.49			5	180	30	2.68	0.63
Low (TargetPos=1)	Right (Hand=2)	1	0	29	1.93	0.45	Low (TargetPos=1)	Right (Hand=2)	1	0	30	1.90	0.50
		2	45	27	2.67	0.45			2	45	30	2.57	0.60
		3	90	27	2.97	0.45			3	90	30	2.82	0.65
		4	135	30	3.21	0.48			4	135	29	2.99	0.81
		5	180	26	3.30	0.42			5	180	29	2.88	0.60
Mid (TargetPos=2)	Right (Hand=2)	1	0	30	2.17	0.46	Mid (TargetPos=2)	Right (Hand=2)	1	0	29	2.20	0.62
		2	45	30	2.74	0.48			2	45	30	2.65	0.58
		3	90	29	3.05	0.46			3	90	30	2.74	0.66
		4	135	30	3.10	0.54			4	135	30	2.89	0.78
		5	180	28	3.24	0.54			5	180	30	2.77	0.67
High (TargetPos=3)	Right (Hand=2)	1	0	30	2.47	0.49	High (TargetPos=3)	Right (Hand=2)	1	0	30	2.42	0.57
		2	45	28	2.76	0.57			2	45	29	2.68	0.57
		3	90	30	2.95	0.53			3	90	29	2.74	0.63
		4	135	28	3.02	0.53			4	135	30	2.77	0.67
		5	180	28	3.05	0.56			5	180	30	2.66	0.58

To analyze the data, a split plot ANOVA was developed using Statistx 8.0. Two ANOVAs were generated, one that analyzed the dominate (right) hand and one that analyzed the non-dominate (left) hand (Table 4.2). The ANOVAs analyzed the average hand speed data with gender as a between subject variable and hand (left or right), start position, target position as a within subject variable.

The ANOVAs for the dominate and non-dominate hands compared the means of male and female hand speed from all positions (H_0 = means are equal) found no significant difference between males and females (failed to reject H_0 , at $p_{value}=0.1012$ and 0.0538) for this study. The ANOVA compared the mean of hand speed (H_0 = means are equal) against the three target positions and found no significant difference between low, mid, high positions for either the dominate or non-dominate hands (failed to reject H_0 , at $p_{value}=0.3789$ and 0.2831). Neither ANOVA found a significant interaction between Gender by Target-Position.

Table 4.2: ANOVA for Dominate and Non-Dominate, Average Hand Speed vs Gender, Target Position, & Start Position

	Avg Hands Speed vs Gender, Target Position, Start Position Dominate (Right) Hand					Avg Hands Speed vs Gender, Target Position, Start Position Non-Dominate (Left) Hand				
	DF	Sum Squares	Mean Squares	F	P	DF	Sum Squares	Mean Squares	F	P
Subject (Hand Speed m/s)	29	93.3672	3.2196			29	90.5959	3.1240		
Gender	1	8.076	8.0761	2.86	0.1021	1	9.5287	9.5287	4.04	0.0538
Error: Subject*Gender	29	81.7487	2.8189			29	68.3669	2.3575		
Target Position	2	0.3118	0.1559	0.98	0.3789	2	0.4562	0.2281	1.28	0.2831
Gender * Target Position	2	0.0376	0.0188	0.12	0.8888	2	0.0596	0.0298	0.17	0.8466
Error: Subject*Gender * Target Position	116	18.4811	0.1593			116	20.7397	0.1788		
Start Position	4	80.7218	20.1805	169.82	0.0000	4	90.2225	22.5556	185.11	0.0000
Gender * Start Position	4	4.5081	1.1270	9.48	0.0000	4	6.8085	1.7021	6.14	0.0001
Target Position * Start Position	8	11.2013	1.4002	11.78	0.0000	8	13.5083	1.6885	12.34	0.0000
Gender * Target Position * Start Position	8	0.3115	0.0389	0.33	0.9555	8	1.513	0.1891	1.45	0.1718
Error: Subject*Gender * Target Position * Start Position	671	79.7362	0.1188			677	77.6421	0.1147		
Total	874					880				

The ANOVA compared the mean of hand speed ($H_0 = \text{means are equal}$) against the five start-positions and found a significant difference between the start-positions for both the dominant and non-dominant hands (reject H_0 , at $p_{\text{value}} > 0.0000$ for both hands) for this study. The ANOVA also found a significant interaction between Gender * Start-Position and Target-Position * Start Position (reject H_0 , $p_{\text{value}} < 0.0000$ for all) for this study. The ANOVA found no significant interaction between Gender by Target-Position by Start-Position.

The interaction between Gender by Start-Position and Target-Position by Start Position can be evaluated using interaction plots.

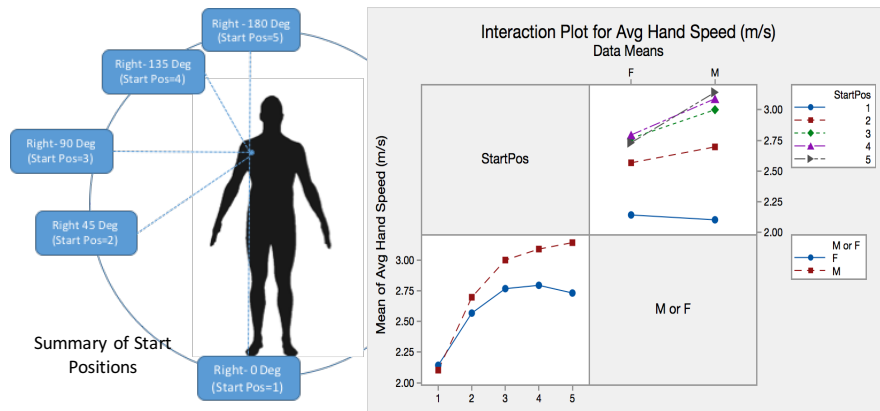

Figure 4.5: Interaction Plot of Mean Hand Speed for Gender by Start-Position

Figure 4.5 shows the interaction between Gender by Start Position. In general, the plot shows that hand speed increases as Start Position (SP) increases. Velocity increases rapidly from SP 1 (arm angle 0° , arm below the waist) to SP 2 (arm angle 45° , arm near waist level). It continues to increase from SP 3 to 5 (arm angle 90° to 180° , arm above waist level) although the rate of

increase slows past SP 3. The rate of change is not as pronounced among female subjects. This interaction is believed to be caused by the changes in arm angle, which allows subjects to better utilize muscles in their back and shoulders for motion as the arm start position moves above their waist. Past research has found that males generate faster hand speed than females (Davies & Mebarki, 1983). This is due to their higher muscularity. As arm angle increases males are better able to apply their back and shoulder muscle capacity to the over-reach task.

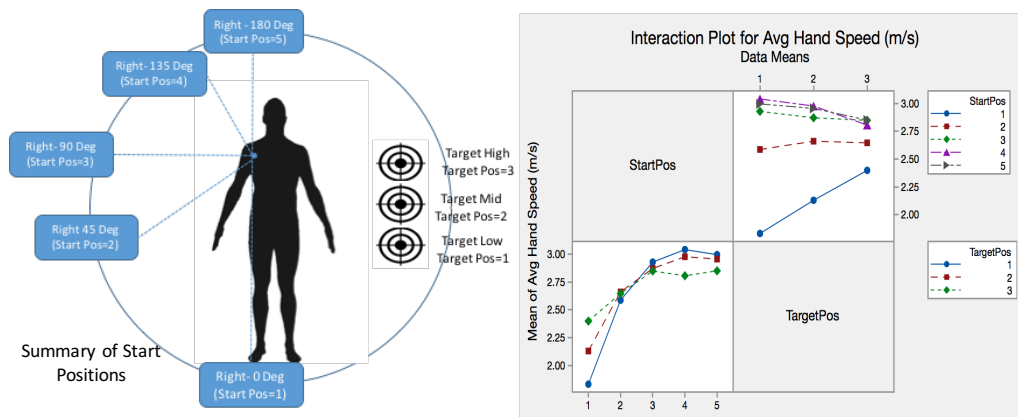

Figure 4.6: Interaction Plot of Mean Hand Speed for Target Position by Start Position

Figure 4.6 shows the interaction between Target Position by Start Position. In general, the plot shows that hand speed increases as arm angle increases. Speed increases rapidly from SP 1 (arm angle 0°, arm below the waist) to SP 2 (arm angle 45°, arm near waist level). It continues to increase from SP 3 to 5 (arm angle 90° to 180°, arm above waist level) although the rate of increase slows past SP 3. As previously discussed, this interaction is at least partially explained by the changes in arm angle, which allow subjects to better utilize muscles in their back and shoulders for motion as the arm start position moves above their waist. The interaction with the

target position is believed to be caused by the changes in distance the subjects experience as start position moves from below the waist to above the waist. An over-reach movement is a ballistic movement, with a rapid acceleration and deceleration phase at the start and finish of the movement, with an extended period of movement toward the target at the subject maximal hand speed (Prasad, Kellokumpu, & Davis, 2006). The longer the ballistic movement the higher the average hand speed since the subject spends longer at maximum velocity (Jensen, 1989). When the subjects arm angle is at 0° (SP 1, below waist level) the longest reach is Target Position 3 (high target), which has the highest over-reach velocity of the three targets. When the subjects arm angle is at 45° (SP 2, waist level) the targets are at nearly the same distance so there is no major difference in hand speed. As the subject start position moves to 90° , 135° , and 180° (SP 3, 4, & 5), Target Position 2 (mid target) and 3 (high target) becomes the closest target with Target 1 the furthest away. The average hand speed to Target Position 1 becomes the larger value and the speeds to Target Position 2 and 3 decreasing relative to Target Position 1.

4.11 Discussion of Results

This study was conducted with the intent of developing a normal distribution of the sample and estimating the hand speed of the 95th percentile for both the male and the female populations. Typically standards are set to protect 95% of the working population as a compromise between “protection and practicality” since the cost of protecting 100% of the population can be very high (Jensen, 2017).

The maximum hand speeds measured in this study occurred at SP=4 (arm angle 135°) for both males and females. In a well-designed process, part handling should occur in a neutral arm

position so the operators hands should be close to waist level (SP=2, arm angle 45°) and at worst case shoulder level (SP=3, arm angle=90°). An estimate of the 95th percentile for these positions is shown in Table 4.3.

Table 4.3: Estimated Hand Speed Dominate and Non-Dominate Hand for Male and Female Subjects (Target Position Data Pooled)

Population Percentage	Dominate Hand, SP-2 Hand Speed (m/s)		Dominate Hand, SP-3 Hand Speed (m/s)		Non-Dominate Hand, SP-2 Hand Speed (m/s)		Non-Dominate Hand, SP-3 Hand Speed (m/s)	
	Male	Female	Male	Female	Male	Female	Male	Female
10 th	2.08	1.89	2.38	1.94	2.08	1.72	2.36	1.98
20 th	2.30	2.14	2.59	2.23	2.28	1.99	2.58	2.25
30 th	2.46	2.33	2.74	2.43	2.43	2.18	2.74	2.44
40 th	2.60	2.48	2.87	2.60	2.55	2.35	2.88	2.61
50 th	2.72	2.63	2.99	2.76	2.67	2.50	3.01	2.77
60 th	2.85	2.78	3.11	2.93	2.79	2.66	3.14	2.92
70 th	2.98	2.93	3.24	3.10	2.92	2.82	3.28	3.09
80 th	3.14	3.12	3.39	3.30	3.06	3.02	3.44	3.29
90 th	3.36	3.37	3.60	3.58	3.27	3.28	3.66	3.56
95th	3.55	3.58	3.77	3.82	3.44	3.51	3.85	3.79
100 th	4.53	4.73	4.72	5.08	4.36	4.71	4.85	5.00

A plot of Average Hand Speed versus Start Position Dominant and Non-Dominant Hand (Figure 4.7) compares the results of this study with the OSHA and ISO hand speed constant. Based on the 95th percentile for the sample group, the current OSHA hand speed constant of 1.6 m/s is not protective of this population under the conditions of this study. The hand speed constant recommended by ISO 13855 (2.0 m/s) is protective for approximately 10% of this population under the conditions of this study (ISO, 2010).

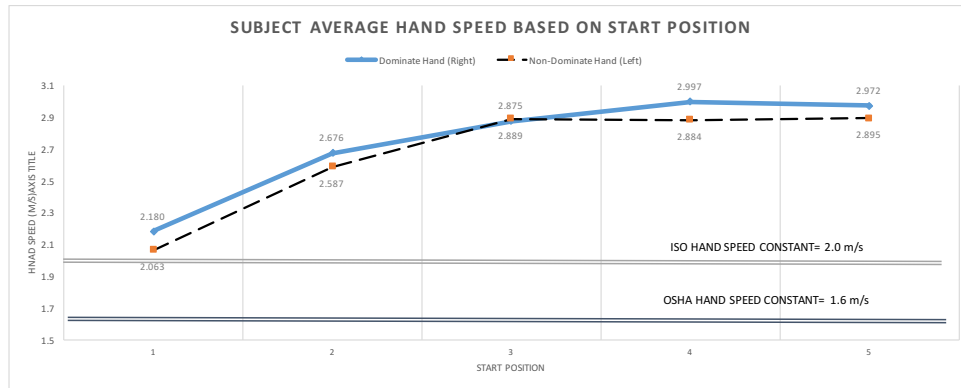

Figure 4.7: Start Position Versus Average Hand Speed Dominate and Non-Dominate Hand (Gender and Target Position Data Pooled)

4.12 Conclusions

Operator over-reach speed on power presses and PSD applications is a complex issue. This experiment was conducted with thirty (30) male and thirty (30) female subjects with the intent of developing a normal distribution of the sample and estimating the hand speed of the 95th percentile for both the male and the female population. The study found that a hand speed constant between 3.5 m/s to 3.9 m/s would protect 95% of a population age 20-30 years old. The current OSHA hand speed constant of 1.6 m/s is not protective of this population under the conditions of this study. The hand speed constant recommended by ISO 13855 (2.0 m/s) is protective of 10-15% of this population under the conditions of this study.

OSHA should consider revising its hand speed constant and affected standards to better protect young workers from known and prevalent guarding hazards.

Chapter 5

Evaluating an IMU Based System for After-Reach Speed Measurement

5.1 Abstract

The objective of this study was to measure the hand speed of eighteen (18) subjects making after-reach movements from an upper palm button (UB) and lower palm button (LB) to a target on a simulated press. Each after-reach movement was measured with a Vicon optical motion capture system and an Xsens IMU based motion capture system. A Bland-Altman analysis of the speed measured by the two technologies demonstrated a general agreement (average bias 0.19 m/s) between the measurements and a potential for using IMUs for hand-speed measures in the future. However, the use of an Xsens system for this type of measure seems impractical. The computation intensity required to manipulate the Xsens data is likely too complex and time consuming for safety practitioners who are busy with day to day plant activities. The IMU technology exhibits reasonable accuracy for ballistic hand speed measurement. A simple IMU system, designed specifically for hand speed capture, could be a viable option for measuring after-reach speed in the future. The operation of IMUs in a ferromagnetic and electromagnetic rich environment, like that found on the factory floor, must be evaluated before the technology may be considered for adoption in industry.

5.2 Introduction

The OSHA 1910.217 (1971) standard established safety requirements for mechanical presses in the USA. The standard was revised in 1973 to improve machine control reliability and point-of-operation safeguarding (Baldwin, 1976). One of the point-of-operation improvements was the development of a safe distance formula for dual palm buttons and light curtains to prevent after-reach errors. After-reach occurs when a worker attempts to reach into the press after the downward motion of the ram has been actuated. This is believed to be an inadvertent, automatic response to clear a process upset in the die (NIOSH, 1987). The safe distance formula contains a hand speed constant based on the work of Löbl (OSHA Etool Website, 2017), who estimated that after-reach hand speed was 63 inches/second (or 1.6 m/s) (Lobl, 1935).

Palm buttons are a two-hand-capture device intended to reduce the risk of hand injury when operating a press. They allow the machine to cycle only if both buttons are pressed at the same time, ensuring that an operator's hands cannot be in the die during the start of the downward stroke of the press. The use of two-hand palm buttons and light curtains reduces the risk of after-reach errors. After-reach is believed to occur when workers notice scrap in the die or a miss-set blank and attempt to clear it after the machine cycle has started, but before the die closes. Reaching into the die during the press's downward stroke can result in the worker's fingers, hand, or arm being in the point-of-operation when the press closes. The "safe distance"

calculation establishes a set-back that is intended to decrease the likelihood that an operator can physically reach into the press before it closes.

Numerous researchers have studied after-reach speed (Pizatella & Moll, 1987), (Pizatella, Etherton, Jensen, & Oppold, 1983), (Horton, Pizatella, & Plummer, 1986), (Jensen & Stobbe, 2016) (Jensen, 2017), (Kato et al., 2001). The majority of the researchers have reported after-reach speeds higher than the 1.6 m/s value found by Löbl in 1935.

In March 1987, in response to the evidence amassed by research scientists (Pizatella, Moll, Horton, and others), The National Institute for Occupational Safety and Health (NIOSH) issued Current Intelligence Bulletin (CIB) 49. The CIB warned employers that the OSHA hand speed constant was not protective for all workers and that additional safety precautions were necessary for some workers:

“Caution must be exercised in evaluating each power press set-up and operation to ensure that an adequate safety distance is maintained at all times. Employers should consider evaluating individual press operators to determine if they are exceeding the current OSHA hand-speed constant. If a worker is identified as being capable of exceeding the hand-speed constant, more positive means of point-of-operation safeguarding should be considered, such as fixed barrier guards.” (NIOSH, 1987)

NIOSH did not recommend a method for evaluating press operators to determine if they were “exceeding the current OSHA hand-speed constant.”

5.3 Inertial Measurement Systems

Inertial Measurement Systems (IMUs) are small, portable devices that measure acceleration, velocity, and position using miniature electro-mechanical sensors. IMUs are a product of micro-machining technology that allow the fabrication of computer board level mechanical devices. Most IMUs contain three orthogonal rate-gyroscopes and three orthogonal accelerometers, which measure angular velocity and linear acceleration (Woodman, 2007). Because gyroscopes are prone to drift, the system also contains three magnetometers which are designed to sense the earth's magnetic field and locate magnetic north. The output from the sensors are combined in a recursive algorithm called a Kalman Filter. This algorithm is designed to combine the data from the three types of "complementary sensors" (a technique termed sensor fusion) to minimize drift and allow the more accurate calculation of acceleration, velocity and position (Roetenberg, Luinge, & Slycke, 2009).

Acceleration can be calculated directly from the output of the accelerometer (Figure 5.1) in an IMU. Velocity is calculated by integrating the accelerometer output and position is calculated by integrating the velocity.

The design of Kalman algorithm is a critical part of the accuracy of an IMU system. Since position data is calculated by the integration of sensor output, small errors in the accelerometer or gyroscope output build rapidly in to larger errors in velocity (a single integrated value) and position (a double integrated value). (Woodman, 2007)

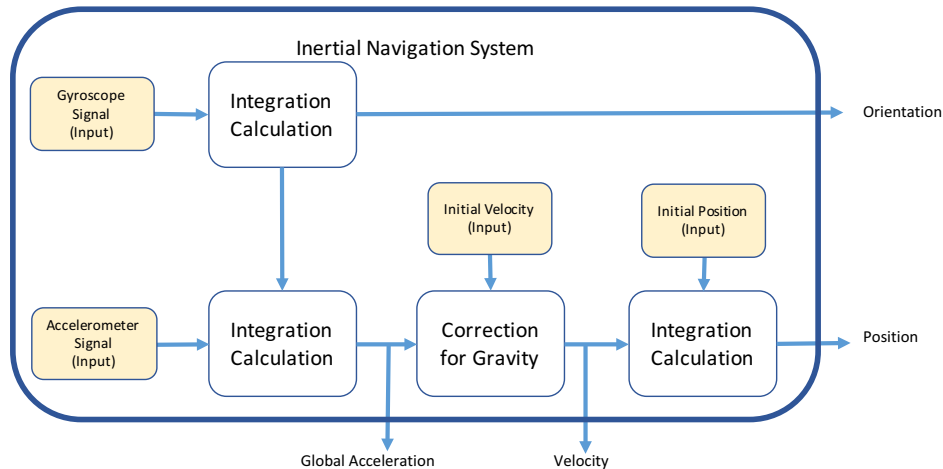

Figure 5.1: Calculation Flow Diagram of an Inertial Navigation System

Figure Based on (Woodman, 2007)

Another source of IMU error is magnetic interference. The presence of iron (machines, rebar in floors, and so forth) in the test area can distort the earth’s magnetic field and interfere with the magnetometer output, introducing error into the sensor fusion calculation (de Vries, Veeger, Baten, & van der Helm, 2009)

A system of IMUs can be purchased in a fully integrated, commercial package that is designed for full body motion capture. For example, Xsens MVN Biomech Awinda (Xsens Technologies B.V., P.O. Box 559, 7500 AN Enschede, Netherlands) is a small, lightweight motion tracking system. It consists of seventeen, individual, wearable IMU (47 x 30 x 13 mm) sensors. The IMUs include an on-board battery and wireless communication to a proprietary motion capture software package.

Xsens uses a proprietary data fusion algorithm which combines both sensor output and user entered anthropometric data. “The system is unique in its approach to estimating body segment orientation and position changes by integration of gyroscope and accelerometer signals which are continuously updated by using a biomechanical model of the human body. This allows for tracking of dynamic motion. By facilitating the constraints of the model, notably, the segments are connected by joints, the kinematics of body segments are corrected for drift and other errors” (Roetenberg et al., 2009). The Xsens motion capture (MoCap) system has been used in movie computer animation, biomechanical studies, and ergonomic studies. (Roetenberg et al., 2009)

5.4 IMUs versus Optical Motion Capture

IMU based MoCap systems, like Xsens, are an important innovation for human factors and ergonomics researchers since they have the potential to allow the less invasive measurement of workers on the factory floor. Traditional motion capture research has relied on optical motion capture systems (OMC). OMC systems use multiple cameras to triangulate the position of reflective markers secured to the test subject. OMC systems provide very precise position data collected at high speed (frame count 120 Hz or greater), but are not compact or portable. OMC position data can be used to calculate velocity, acceleration, joint angles and so forth and is accurate [system error is less than 2 mm during dynamic movement (Merriault, Dupuis, Bouteau, Vasseur, & Savatier, 2017)]. Optical motion capture is considered the gold standard for segmental kinematic measurements (Ceseracciu, Sawacha, & Cobelli, 2014).

However, OMC based research is usually confined to the research lab. OMC requires multiple cameras installed in multiple locations to view the target from multiple angles to clearly capture

the movement. Lighting is critical and cameras must be rigidly mounted to minimize vibration and camera movement. The capture volume is limited and data capture is line of sight, so subjects cannot reach into blind areas (areas not seen by the cameras) or turn their body so the cameras cannot “see” the reflectors.

OMC systems can be purchased as fully integrated, commercial packages. Vicon (Vicon, Oxford, 14 Minns Business Park, West Way, Oxford England, OX2 0JB) provides an integrated system that provides cameras, reflectors and software designed to capture and model the motion data.

The ease of use and potential for using IMU based motion capture in the workplace, has generated a flurry of research activity to demonstrate IMU MoCap accuracy and compare it to the “gold standard” OMC. Table 5.1 summarizes the research effort and the finding generated:

Table 5.1: Summary of IMU Accuracy Research

Date	Study	Findings	Reference
2001	Validation of Inertial Measurement Units With an Optoelectronic System for Whole-Body Motion Analysis	Compared to OMC; Studied joint angle “ . . . error remained under 5° RMSE during handling tasks, which shows potential to track workers during their daily labor.”	(Robert-Lachaine, Mecheri, Larue, & Plamondon, 2017)
2005	Inertial Measurements of Upper Limb Motion	Development of portable IMU motion tracker to aid in home rehab of stroke victims. System demonstrated less than 5% error (arm angle, slow movements) compared to OMC.	(Zhou, Hu, & Tao, 2006)
2007	Ambulatory Measurement	Study of upper arm kinetics using an	(Luinge, Veltink, &

	of Arm Orientation	“ambulatory system.” IMU vs OMC using RMS. IMU software model that incorporates “joint restrictions” improves accuracy.	Baten, 2007)
2007	Inertial Sensors for Motion Detection of Human Upper Limbs	Study of portable IMU motion tracker to aid in home rehab of stroke victims. “The motion detector using the proposed kinematic model only has drifts in the measurements. Fusion of acceleration and orientation data can effectively solve the drift problem without the involvement of a Kalman filter.”	(Zhou & Hu, 2007)
2008	Magnetic Distortion in Motion Labs, Implications for Validating Inertial Magnetic Sensors	Compared to OMC; Studied joint angle. Accuracy in the presence of iron was acceptable but performance deteriorated in 20-30 sec	(de Vries et al., 2009)
2008	Dynamic Accuracy of Inertial Measurement Units During Simple Pendulum Motion	Tested IMU against OMC . . . “The IMU measurement of pendulum motion using the vendor's Kalman filter algorithm did not compare well with the video motion capture with a RMS error of between 8.5° and 11.7° depending on the length and type of pendulum swing. The maximum orientation error was greater than 30°, occurring approximately eight seconds into the motion.	(Brodie, Walmsley, & Page, 2008)
2008	Use of Multiple Wearable Inertial Sensors in Upper Limb Motion Tracking	IMU vs OMC measuring wrist & elbow joint angle. “Experimental results demonstrate that this new system, compared to an optical motion tracker, has RMS position errors that are normally less than 0.01 m, and RMS angle errors that are 2.5°–4.8°.”	(Zhou, Stone, Hu, & Harris, 2008)
2009	A Distributed Wearable, Wireless Sensor System for Evaluating Professional Baseball Pitchers and	Compared to OMC; Studied Acceleration & Arm Speed; Compared joint angle. Evaluation of Pitchers and Batters using a specially designed high	(Lapinski, Berkson, Gill, Reinold, & Paradiso, 2009)

	Batters	speed data capture (200 Hz) IMU.	
2009	Accuracy of Inertial Motion Sensors in Static, Quasistatic, and Complex Dynamic Motion	Tested IMU against OMC using RMSE analysis. Studied arm movement during static, quasistatic, and dynamic motion. RMS error was 1.9° to 3.5° during pendulum movement. Error higher in complex arm movement. Acceptable accuracy for field study.	(Godwin, Agnew, & Stevenson, 2009)
2010	Feasibility of Using Inertial Sensors to Assess Human Movement	Comparison of IMU system to electromagnetic sensors for hip measurement during walking. Measurements obtained for hip joint movement during walking were flexion 38.8°, extension 6.6°, step frequency 1.02 Hz. “We conclude that the inertial sensors studied have the potential to be used for motion analysis and clinical research.”	(Saber-Sheikh, Bryant, Glazzard, Hamel, & Lee, 2010)
2012	Shoulder and Elbow Joint Angle Tracking With Inertial Sensors	Improved Kalman filter algorithm increases accuracy. Tested IMU against OMC using RMSE analysis. “RS angle error of less than 8° for all shoulder and elbow angles.”	(El-Gohary & McNames, 2012)
2013	Inertial Measures of Motion for Clinical Biomechanics: Comparative Assessment of Accuracy under Controlled Conditions - Effect of Velocity	IMU “systems demonstrated good absolute static accuracy (mean error, 0.5°) and clinically acceptable absolute accuracy under condition of slow motions (mean error between 0.5° and 3.1°). In slow motions, relative accuracy varied from 2° to 7° depending on the type of AHRS and the type of rotation. Absolute and relative accuracy were significantly affected by velocity during sustained motions. “	(Lebel, Boissy, Hamel, & Duval, 2013)
2013	Performance Evaluation of a Wearable Inertial Motion Capture System for Capturing Physical Exposure During Manual	Application of IMU in a work environment (lifting/material handling). Tested IMU against OMC to compare joint angle and joint velocity. “The IMU system yield peak	(Kim & Nussbaum, 2013)

	Material Handling	kinematic values that differed up to 28% from OMC system.” Acceptable accuracy for field use.	
2015	A Comparison of Instrumentation Methods to Estimate Thoracolumbar Motion in Field-Based Occupational Studies	Compared to Lumbar Motion Monitor using RMSE. “Results suggest investigators should consider computing thoracolumbar trunk motion as a function of estimates from multiple IMUs using fusion algorithms rather than using a single accelerometer secured to the sternum in field-based studies.”	(Schall, Fethke, Chen, & Gerr, 2015)
2016	Validation of Inertial Measurement Units With an Optoelectronic System for Whole-Body Motion Analysis	Compared to OMC; Evaluated Joint Angle using RMSE “Error remained under 5° RMSE during handling tasks, which shows potential to track workers during their daily labor.”	(Robert-Lachaine, Mecheri, Larue, & Plamondon, 2017)
2016	Accuracy and Repeatability of an Inertial Measurement Unit System for Field-Based Occupational Studies	Compared to OMC “The accuracy and repeatability of an inertial measurement unit (IMU) system for directly measuring trunk angular displacement and upper arm elevation were evaluated over eight hours . . . Sample-to-sample root mean square differences between the IMU and OMC system ranged from 4.1° to 6.6° for the trunk and 7.2°–12.1° for the upper arm depending on the processing method . . . IMU systems may serve as an acceptable instrument for directly measuring trunk and upper arm postures in field-based occupational exposure assessment studies with long sampling durations.”	(Schall, Fethke, Chen, Oyama, & Douphrate, 2016)

5.5 Research Aim

It is clear from the literature that the 1.6 m/s OSHA hand speed constant is not protective for all press operators. Multiple studies have found after-reach speeds that exceed the 1.6 m/s OSHA

constant and that hand speeds vary significantly between subjects and based on palm button placement and orientation. NIOSH recommends that press operators with high hand speeds be evaluated to determine if they are “exceeding the current OSHA hand-speed constant.” These “at risk” operators would require additional safeguards.

The present study is designed to evaluate an Xsens (IMU-based motion capture) system and compare its accuracy to a Vicon (optical motion capture) system. If the Xsens accuracy is equivalent to Vicon, it would be possible for safety practitioners to conduct hand speed trials on the factory floor and identify press operators who are at risk for after-reach accidents.

5.6 Equipment

To estimate the accuracy of an IMU-based system for after-reach speed measurements, subjects were fitted with two motion capture systems. The first system was an optical motion tracking (OMC) manufactured by Vicon (Vicon, Oxford, 14 Minns Business Park, West Way, Oxford England, OX2 0JB). The OMC system used seven (7) Vicon T010 cameras collecting data at 120 Hz. The OMC data was processed using Vicon Nexus 1.8.5 2013 software. The second system was an Xsens Model MVN (Xsens Technologies B.V., P.O. Box 559, 7500 AN Enschede, the Netherlands) which collected data at 60 Hz. The IMU data was processed using Xsens MVN Studio BIOMECH Version 4.2.0 software.

All of the after-reach speed measurements in the literature were collected using a simulated press (Lobl, 1935), (Pizatella & Moll, 1987), (Pizatella et al., 1983), (Jensen, 2017), (Jensen & Stobbe, 2016), (Katoh et al., 2001). Hand speed was measured using a speed trap which measured the time the dual palm buttons were released until the target was touched. The target “hit” was

captured using an electronic or photo-optic switch. The after-reach speed was determined by dividing the straight-line distance from the dual palm buttons to the target by the time measured from palm button release to target strike.

A simulated press was constructed for this experiment (Figure 5.2). The fixture mimicked the geometry of commercially available power presses and included dual palm buttons at waist and shoulder height. The simulated two hand start buttons (56 cm apart) were mounted at waist height (84 cm from the floor) and shoulder height (160 cm from the floor) with a near waist height after-reach target (107 cm from the floor). These dimensions are typical of free standing, C frame presses being built today (based on a review of the catalogues of six different press manufacturers) and the same as used by several of the simulated press used in other experiments (Pizatella & Moll, 1987) (Horton et al., 1986), (Jensen, 2017). The apparatus was constructed of wood (to minimize magnetic interference to the IMU system) and counterweighted to prevent tipping, with all sharp edges padded to prevent injury. The press was painted flat black to minimize reflectivity that might interfere with the OMC system (Figure 5.2).

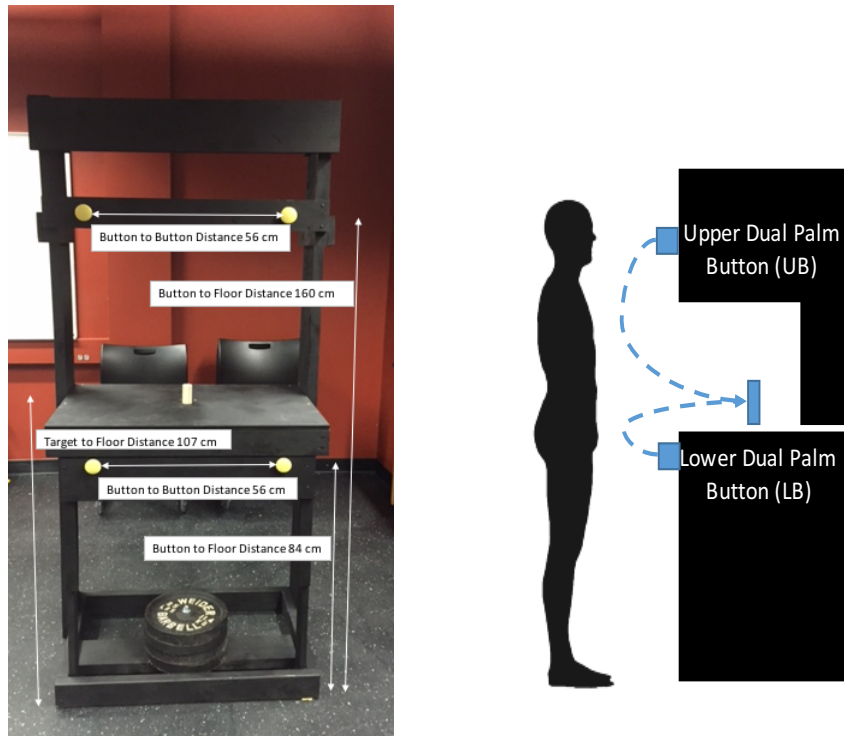

Figure 5.2: Waist Height and Shoulder Height Dual Palm Button Layout

5.7 Subjects

Data for this study was drawn from a larger experiment to measure after-reach speed. Informed consent was obtained before the experiment. The criteria for experimental subjects were to be 19 to 30 years old, with no history of heart disease, stroke or breathing disorder that prevented exercise, and no medical history or injury to their back, shoulders, arms or hands that would prevent rapid movement.

The experiment was conducted using twenty-seven (27) male subjects. The male subjects ranged in age from 20 to 29 years with an average age of 23.6 years old (SD = 2.97 years).

On the day of the experiment, subjects were interviewed to insure they met the requirements of the study, they reviewed the experimental procedure, and signed a voluntary consent form. After signing the consent, the subject's measurements were taken (height and length measurements of their arms, legs, and arm reach). Vicon reflective markers and Xsens IMUs were then placed on the subject's shoulder, elbow, wrist, and hand (Figure 5.3). Only right hand dominant subjects were used in this experiment.

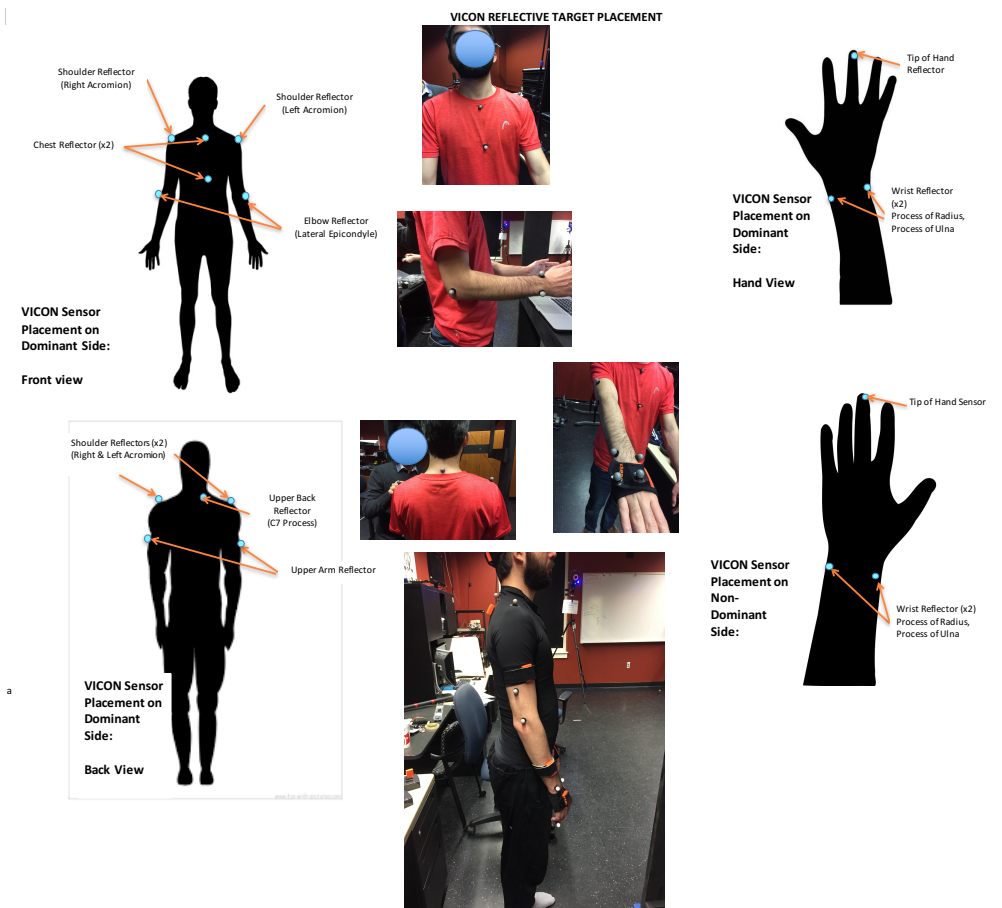

Figure 5.3: Vicon Reflective Markers and IMUs Used to Identify Kinematic Segments

After placing the IMUs, the subject's anthropometric measurements were entered into the Xsens MVN Studio software, which allowed Xsens to establish a model of the subject's body segment lengths. The Xsens system was then calibrated with an "N-pose" (arms neutral beside the body) to establish the sensor to segment orientation for each IMU sensor (Roetenberg et al., 2009). The MVN Studio software rated the sensor to segment calibration quality (good, acceptable, fair, and poor); only systems calibration rated as good or acceptable were used in this study.

The study consisted of the subject reaching from the waist height palm button (LB) to the target and from the shoulder height palm button (UB) to the target (Figure 5.2). The study was a randomized design with order of the conditions decided based on a coin flip. At the start of the experiment, the trial plan was explained to the test subject and the subject was asked to practice each movement until they felt comfortable before an actual measurement was taken. Participants were instructed to reach for the target with their right hand. The subject was given a "one-two-three-go" signal and then asked to make a rapid hand movement from the fixed starting position to the target position. The movement was repeated three times. After completing the three trials, the researcher explained the next start position, the subject was allowed to practice, and the subsequent trial was performed.

5.8 Data Collection and Analysis

The majority of Xsens/Vicon comparison studies (Table 5.1) were position based. The x, y, and z positions for a movement were extracted from the IMU system and the OMC system and the position curves were compared using root mean squared error analysis. Accuracy results were reported as joint angles. For this study, the position data was extracted from both systems and

converted to a velocity by dividing by time. This allowed the direct comparison of after-reach speed for each trial.

Several hurdles had to be overcome to develop an objective comparison between the two systems. Since the Xsens system was developed as a MoCap system, much of the data developed by the MVN Studio BIOMECH program is calculated for the center of the joints (for example the right wrist) rather than the appendages (the right hand). To allow a direct correlation with the Xsens position data for the right wrist during an after-reach event, Vicon markers were attached to the left and right sides of the wrist. The Vicon velocity data for both wrist markers was averaged estimate velocity for the center of the wrist.

During an after-reach movement, the operator's hand moves along a curvilinear path from the palm button (start position) to the target (Figure 5.4). Velocity data for the wrist joint can be downloaded directly from Xsens. However, this velocity data is the angular velocity of the wrist as it travels along the curvilinear path to the target. This velocity is higher than the linear velocity. OSHA's hand speed constant is based on the linear velocity of the hand as it moves toward the target. To provide an "apples to apples" comparison of hand speed a Python program (Version 2.7) was used to extract the position data, approximate the linear distance from current position to the point of origin (linear distance), and calculate the average velocity of the movement over the travel path.

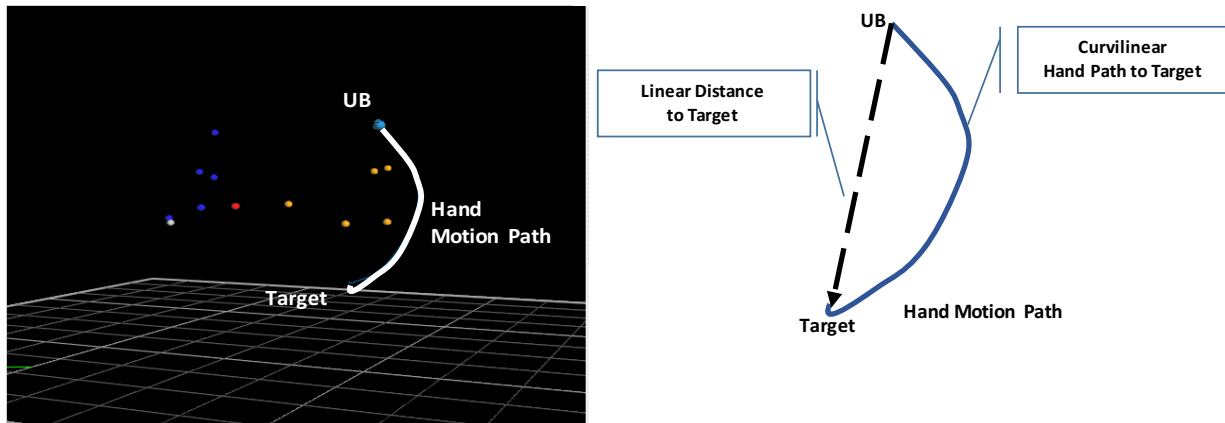

Figure 5.4: Trace Showing Hand Path Traveled During an After-reach Event

(Based on Vicon Data)

5.9 Statistics

The average velocity for each trial was compared using a Bland-Altman Plot. The Bland-Altman methodology was developed in the 1980's and is designed to compare two methods of measure and determine if they agree statistically. If the methods “agree” then they are interchangeable and either can be used without a significant loss of accuracy (Altman & Bland, 1983), (Bland & Altman, 1995), (Bland & Altman, 2010). The Bland-Altman technique involves plotting the average of the reading taken by both devices against their difference for each trial. If the plotted points fall between the limits of agreement (LOA) for the process (two standard deviations from the mean) the instruments are in agreement. Bland and Altman have continued to refine the technique and extend their method to experiments with repeated measure in 2010 (Bland & Altman, 2010). Zou suggested improvements to the method of calculating the LOA based on a one-way random effects model measures when the true experimental value varies trial to trial (Zou, 2013).

The study included twenty-seven (27) male subjects who attempted three trials at the waist height palm button (LB) location and three trials from the shoulder height palm button (UB) location. Only subjects that completed three complete trials without gaps in the position data were included in the analysis. Of the twenty-seven trials for the UB after-reach, three of the Xsens files were missing or corrupted and six of the Vicon files had gaps in the position data (subject's wrist rotated during the movement, obscuring the reflector for either the left or right wrist marker) and were not included in the analysis. For twenty-seven runs LB after-reach trials three of the Xsens files were corrupted and six of the Vicon files had gaps in the position data (subject's wrist rotated during the movement, obscuring the reflector for either the left or right wrist marker) and were not included in the analysis.

The eighteen UB after-reach speed runs (3 trials/run) measured by Vicon averaged 1.40 m/s (SD = 0.24 m/s). This is the average speed of the left & right side of the wrist and represents the center of the wrist. The eighteen UB after-reach speed runs (3 trials/run) measured by Xsens averaged 1.22 m/s (SD = 0.23 m/s). An analysis of the normality of the difference of the two methods using the Anderson Darling Test (H_0 = Data follows a normal distribution) failed to reject the H_0 ($p_{\text{value}} = 0.7840$). The Bland-Altman plot of the data is shown in Figure 5.5. The Limits of Agreement were calculated using the method recommended by Zou.

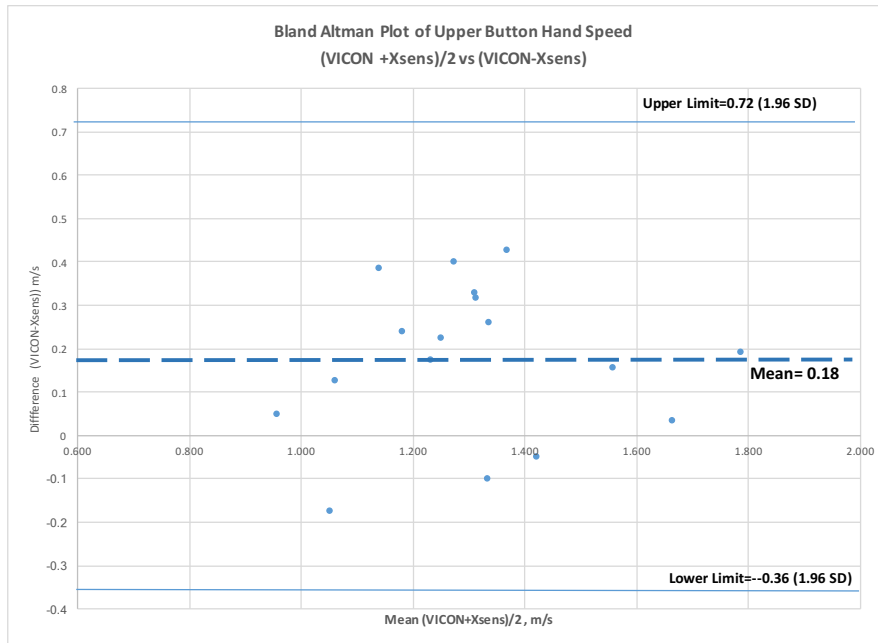

Figure 5.5: Bland-Altman Plot of UB After-reach Speed,
Comparison of Vicon and Xsens

The Bland-Altman Plot for the UB after-reach (Figure 5.5) indicates that all values fall inside the upper and lower limits of agreement. The difference of the values (Vicon-Xsens) indicate a bias of 0.18 m/s.

The eighteen LB after-reach speed runs (3 trials/run) measured by Vicon averaged 0.94 m/s (SD = 0.16 m/s). This is the average speed of the left & right side of the wrist (i.e. representing the center of the wrist). The eighteen LB after-reach speed runs (3 trials/run) measured by Xsens averaged 0.74 m/s (SD = 0.15 m/s). An analysis of the normality of the difference of the two methods using the Anderson Darling Test (H_0 = Data follows a normal distribution) failed to reject the H_0 ($p_{\text{value}} = 0.2631$). The Bland-Altman plot of the data is shown in Figure 5.6. The Limits of Agreement were calculated using the method recommended by Zou.

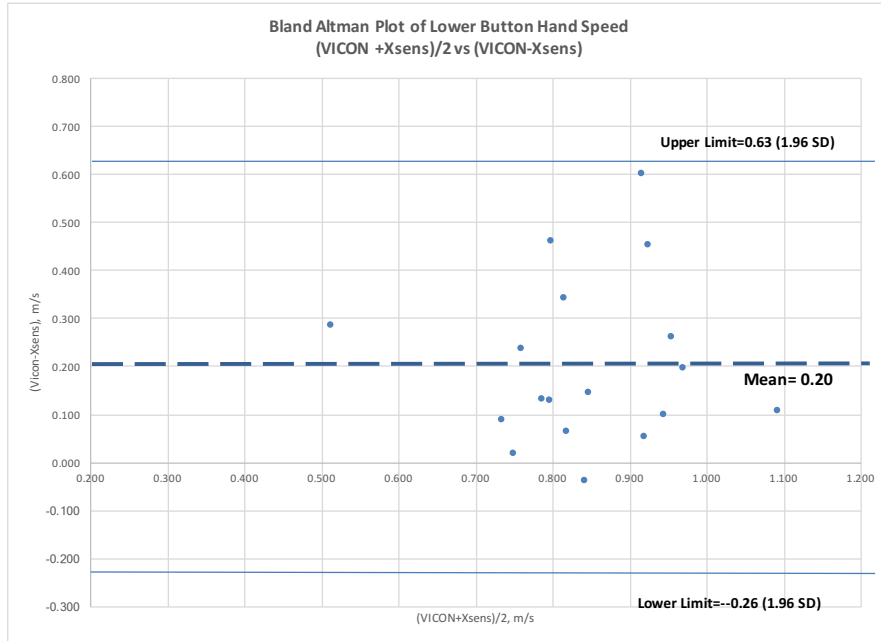

Figure 5.6: Bland-Altman Plot of LB After-reach Speed,
Comparison of Vicon and Xsens

The Plot for the LB after-reach (Figure 5.6) shows that all plotted values fall inside the upper and lower limits of agreement. The difference of the values (Vicon-Xsens) shows a bias of 0.20 m/s.

The bias between the UB (0.18 m/s) and LB (0.20 m/s) plots were different but an ANOVA of the differences ($H_0 = \text{values are equal}$) failed to reject the H_0 ($p_{\text{value}} = 0.6444$).

5.10 Discussion of Results

The data (UB/LB) were normally distributed and are good candidates for Bland-Altman analysis (Altman & Bland, 1983). Both plots demonstrated bias, but in general they indicate acceptable agreement between the two methods. The difference of the individual trials was calculated as

“Vicon-Xsens”, so the positive value of both biases indicates that the Xsens measurements are consistently lower than the Vicon measurements. This can be corrected by adding the bias value to the Xsens speed measurement.

The general agreement between the two speed measurement methods show a potential for using IMUs for speed measure in the future. However, the use of an Xsens system for this type of measure seems impractical. The Xsens system is designed for motion capture. The Xsens software is designed to track joint velocity rather than finger or hand velocity. The computational intensive procedures required to download the joint position data, manipulate it to hand position, and calculate the linear velocity from this data may be too complex and time consuming for typical safety practitioners who are busy with day-to-day plant activities. However, the IMU system exhibits reasonable accuracy for ballistic hand speed measurement. A simple IMU system, designed specifically for hand speed capture, could be a viable application for measuring after-reach speed for dual palm buttons and light curtain equipment.

Future work examining the performance of IMU based systems operating in areas with significant ferromagnetic and electromagnetic inference, like that found on the factory floor, is required before this technology could be adopted by industry.

5.11 Conclusions

The objective of this study was to measure the hand speed of eighteen (18) subjects making after-reach movements from an upper palm button (UB) and lower palm button (LB) to a target on a simulated press. Each after-reach movement was measured with a Vicon optical motion

capture system and an Xsens IMU based motion capture system. A Bland-Altman analysis of the speed measured by the two technologies demonstrated a general agreement (average bias 0.19 m/s) between the measurements and a potential for using IMUs for speed measures in the future. The IMU technology exhibits reasonable accuracy for ballistic hand speed measurement. A simple IMU system, designed specifically for hand speed capture, could be a viable application for measuring after-reach speed in the future. The operation of IMUs in a ferromagnetic and electromagnetic rich environment, like that found on the factory floor, must be evaluated before the technology may be considered for adoption in industry.

Chapter 6

Conclusions

6.1 Summary of Findings

This research focused on after-reach and over-reach in automated systems. The first after-reach hand-speed study was performed by Oskar Löbl in 1935. The hand-speed Löbl proposed, 1.6 m/s based on a hand start position at a set of horizontal levers to the target in a simulated press, entered the US safety regulations in 1974. The application of this hand speed constant was an attempt by the Occupational Safety and Health Administration (OSHA) to improve point-of-operation safe guarding on power presses. OSHA applied the 1.6 m/s constant to calculating the safe distance on dual palm buttons (without restriction on position or geometry) and presence sensing devices (light curtains, safety mats, and so forth). The 1.6 m/s value was later adopted by ANSI and RIA for point-of-operation safeguarding on robot/automated systems. Several studies have found hand-speed values that exceed the 1.6 m/s value used in the US safety regulations.

The first experiment presented in this dissertation focused on measuring the after-reach speed on a simulated press with “young” workers. Young operators (age 20-30) generate the fastest hand-speed so an after-reach constant based on the 95th percentile of this group would be protective for

the entire worker population. The second part of the dissertation focused on over-reach speeds generated in a simulated automated system with unconstrained hand start position (no dual palm buttons). The final experiment focused on determining the accuracy of Inertial Measurement Units (IMUs) for ballistic hand-speed measurement. An IMU system, designed for hand-speed capture, could be used for measuring after-reach speed in the factory.

The results of the research can be summarized as follows:

- 1) For the simulated press experiment, the 95th percentile hand-speed from the lower button was 1.51 m/s (OSHA hand speed constant protective for > 95% of those tested). The 95th percentile hand speed from the upper buttons was 2.83 m/s (OSHA hand speed constant protective for < 10% of those tested).
- 2) The study found that the hand speed between the UB and LB positions are significantly different, which implies that the use of a single hand speed constant for both locations is inappropriate. The difference in speed appears to be caused by the ergonomic hurdle of disengaging from the supinated wrist position required to use a vertically mounted LB dual palm button (which prevents ballistic movement). The movement from a vertically mounted UB is a ballistic movement.
- 3) Operator over-reach in PSD applications is complex. The study found that a hand speed constant between 3.5 m/s to 3.9 m/s would protect 95% of a population age 20-30 years old in an over-reach situation with unconstrained hand position (no dual palm button). In general, over-reach speed increases as arm angle increases. This increase is at least partially explained by the changes in arm position, which allow subjects to better utilize

muscles in their back and shoulders for motion as the arm start position moves above their waist.

- 4) A Bland-Altman comparison of the speed measured by Vicon (optical motion capture) and Xsens (IMU motion capture) demonstrated a general agreement (average bias 0.19 m/s) between the two technologies. In a Bland-Altman analysis if the methods “agree” then they are interchangeable and either can be used without a significant loss of accuracy. Based on this analysis, an IMU based system could be a viable option for measuring after-reach speed on the factory floor in the future.

6.2 Limitation of the Study

- 1) This was a laboratory-based experiment conducted under environmentally controlled conditions with subjects that were not fatigued from a day’s work. Hand speed performance may decrease due to work conditions (thermal stress, poor lighting, etc.) or worker fatigue.
- 2) The subjects used for these experiments were not press operators. The hand-speed performance of experienced machine operators may be significantly different from unskilled test subjects.
- 3) The experiments were performed on fixtures without moving parts which were padded to prevent injury. The performance of operators on equipment with moving rams, sharp edges, pinch points, and so forth may be significantly different from that of test subjects who face no risk of injury in performing the after-reach/over-reach tasks.

- 4) IMU drift has been associated with magnetic interference. The testing of the IMU system was conducted on a wooden fixture to minimize ferromagnetic interference. IMU performance may degrade in an environment with significant ferromagnetic and electromagnetic interference like that found on the factory floor.

6.3 Recommendations for Future Research

- 1) The over-reach test fixture was based on the target's height used in traditional after-reach studies. A bench marking study of industrial robot/automated cells may find work heights, start positions, and target heights more representative of equipment used in industry. Since over-reach speed is driven by start position, this position/geometry should be tested to provide a complete picture of over-reach speed.
- 2) The frequency of over-reach accidents in industrial robot/automated cells is not known. An examination of robot/automation accidents due to over-reach errors would help to clarify the risk associated with over-reach accidents.
- 3) ANSI/RIA R15.06-2012 includes provisions for robot and humans to work in a shared (collaborative) space. The impact on collaborative robot design of hand speeds faster than those contained in the standards has not been investigated and could be an important area for future safety research.
- 4) Investigation of the performance of IMU based systems operating in areas with significant ferromagnetic and electromagnetic interference will be required before this technology could be applied in industry.
- 5) The use of an Xsens system for after-reach/over-reach measure seems impractical. The computation intensity required to manipulate the Xsens data is likely too complex and

time consuming for safety practitioners who are busy with day-to-day plant activities.

The development of a simple IMU system, designed specifically for hand speed capture, could be a viable option for measuring after-reach speed.

6.4 Acknowledgments

This publication was supported by Grant # 2T420H008436 and 5T420H008438-12 from NIOSH. The findings and conclusions in this report are those of the author and do not necessarily represent the official position of the Centers for Disease Control and Prevention. Use of trade names is for identification only and does not constitute endorsement by the Public Health Service or by the U.S. Department of Health and Human Service.

References

Abrams, A. L. (2016, December). *OSHA's New Walking-Working Surfaces & Fall Protection Requirements*.

Allen, R. L. (2012, August). Machine Safeguarding The Importance of Risk Assessment. *Professional Safety*, 66–69.

Auburn University Graduate School. (2015). Electronic Thesis and Dissertation Guide. Retrieved November 25, 2017, from <http://graduate.auburn.edu/current-students/electronic-thesis-dissertation-guide/>

Altman, D. G., & Bland, J. M. (1983). Measurement in Medicine: The Analysis of Method Comparison Studies. *Journal of the Royal Statistical Society. Series D (The Statistician)*, 32(3), 307–317. <https://doi.org/10.2307/2987937>

ANSI. (1971). *B11.1 Mechanical Power Presses: 1971*.

ANSI. (1982). *B11.1 Mechanical Power Presses: 1982* (No. ANSI B11.1-1982).

ANSI/RIA. (1999). RIA R15.06 -1999: American National Standard for Industrial Robots and Robot Systems — Safety Requirements. Robotic Industries Association 900 Victors Way, Suite 140, Ann Arbor, MI 48108

ANSI/RIA. (2012). RIA R15.06 -2012: American National Standard for Industrial Robots and Robot Systems — Safety Requirements. Robotic Industries Association 900 Victors Way, Suite 140, Ann Arbor, MI 48108

ANSI/RIA. (2014). RIA TR R15.406-2014: Technical Report for Industrial Robots and Robot Systems — Safety Requirements. Robotic Industries Association 900 Victors Way, Suite 140, Ann Arbor, MI 48108.

Au, W. L., Seah, I. S. H., Li, W., & Tan, L. C. S. (2015). Effects of Age and Gender on Hand Motion Tasks. *Parkinson's Disease*, 2015. <https://doi.org/10.1155/2015/862427>

- Bairdstow, P. J. (1987). Analysis of Hand Movement to Moving Targets. *Human Movement Science*, 6, 205–231.
- Baldwin, D. M. (1976, May). The Power Press Controversy- A Status Report. *Job Safety and Health (OSHA)*, Vol 4(5), 12–18.
- Beggs, W. D. A., & Howarth, C. I. (1972). The Movement of the Hand Towards a Target. *The Quarterly Journal of Experimental Psychology*, 24(4), 448–453.
<https://doi.org/10.1080/14640747208400304>
- Bland, J. M., & Altman, D. G. (Eds.). (1995). Comparing Methods of Measurement: Why Plotting Differences Against Standard Method is Misleading. *Lancet*, 346(Oct 21).
- Bland, J. M., & Altman, D. G. (2010). Statistical Methods for Assessing Agreement Between Two Methods of Clinical Measurement. *International Journal of Nursing Studies*, 47(8), 931–936.
- British Standard. Safety of Machinery — Safety Distances to Prevent Hazard Zones Being Reached by Upper and Lower Limbs, BS EN ISO 13857:2008 BS EN ISO 13857:2008 § (2011).
- Brodie, M. A., Walmsley, A., & Page, W. (2008). Dynamic Accuracy of Inertial Measurement Units During Simple Pendulum Motion. *Computer Methods in Biomechanics and Biomedical Engineering*, 11(3), 235–242. <https://doi.org/10.1080/10255840802125526>
- Brown, J. D. (2003). Amputations: A Continuing Workplace Hazard. *Services DoIaM, Ed. NE Washington, DC: US Bureau of Labor Statistics*. Retrieved from <https://www.bls.gov/opub/mlr/cwc/amputations-a-continuing-workplace-hazard.pdf>
- Cattell, D. (2008, January 15). Stamping 101: Anatomy of a Mechanical Press - The Fabricator. Retrieved August 13, 2017, from <http://www.thefabricator.com/article/stamping/stamping-101-anatomy-of-a-mechanical-press>
- Ceseracciu, E., Sawacha, Z., & Cobelli, C. (2014). Comparison of Markerless and Marker-Based Motion Capture Technologies through Simultaneous Data Collection During Gait: Proof of Concept. *PLoS ONE*, 9(3). <https://doi.org/10.1371/journal.pone.0087640>
- Crossman, E. R. F. W., & Goodeve, P. J. (1983). Feedback Control of Hand-Movement and Fitts' Law. *The Quarterly Journal of Experimental Psychology Section A*, 35(2), 251–278.
<https://doi.org/10.1080/14640748308402133>
- Davies, B. T., & Mebarki, M. (1983). Speed of Forward Hand Movement—the Effect of Age, Sex, Posture and Hand. *Ergonomics*, 26(11), 1077–1079.
<https://doi.org/10.1080/00140138308963440>

de Vries, W. H. K., Veeger, H. E. J., Baten, C. T. M., & van der Helm, F. C. T. (2009). Magnetic Distortion in Motion Labs, Implications for Validating Inertial Magnetic Sensors. *Gait & Posture*, 29(4), 535–541. <https://doi.org/10.1016/j.gaitpost.2008.12.004>

El-Gohary, M., & McNames, J. (2012). Shoulder and Elbow Joint Angle Tracking With Inertial Sensors. *IEEE Transactions on Biomedical Engineering*, 59(9). Retrieved from <http://ieeexplore.ieee.org/document/6239576/>

Era, P., Jokela, J., & Heikkinen, E. (1986). Reaction and Movement Times in Men of Different Ages: A Population Study. *Perceptual and Motor Skills*, 63(1), 111–130. <https://doi.org/10.2466/pms.1986.63.1.111>

Etherton, J. (1984). Factors Reported in Amputation and Other Injury Cases at Mechanical Power Presses between 1976 and 1984. In *Proceedings of the Annual International Industrial Ergonomics and Safety Conference* (Vol. Trends in Ergonomics, pp. 629–638). Retrieved from <https://www.cdc.gov/niosh/nioshtic-2/00188598.html>

Fitts, P. (1954). The Information Capacity of the Human Motor System In Controlling the Amplitude of Movement. *Journal of Experimental Psychology*, 47(6).

Flowers, K. (1975). Handedness and Controlled Movement. *British Journal of Psychology*, 66(1).

Fuller, L. J. (1993, November). Mechanical Power Press Bibliography, Second Edition. Triodyne Inc. Retrieved from http://www.triodyne.com/safety~1/sb_v9n1.pdf

Gemma, J. (2017, September). *How Robots Conquer Industry Worldwide*. Presented at the International Federation of Robotics. Retrieved from https://ifr.org/downloads/press/Presentation_PC_27_Sept_2017.pdf

Giavarina, D. (2015). Understanding Bland Altman Analysis. Retrieved October 19, 2017, from <https://www.ncbi.nlm.nih.gov/pmc/articles/PMC4470095/>

Godwin, A., Agnew, M., & Stevenson, J. (2009). Accuracy of Inertial Motion Sensors in Static, Quasistatic, and Complex Dynamic Motion. *Journal of Biomechanical Engineering*, 131(11), 114501. <https://doi.org/10.1115/1.4000109>

Gordon, C. C., Churchill, T., Clauser, C. E., Bradtmiller, B., McConville, J. T., Tebbetts, I., & Walker, R. A. (1989). *Anthropometric Survey of U.S. Army Personnel: Summary Statistics, Interim Report for 1988*. Anthropology Research Project Inc, Yellow Springs OH. Retrieved from <http://www.dtic.mil/docs/citations/ADA209600>

Health and Safety Executive Great Britain. (1999). *Application of Electro-Sensitive Protective Equipment Using Light Curtains and Light Beam Devices to Machinery*. Sudbury, England: HSE.

Horton, J. T., Pizatella, T. J., & Plummer, R. W. (1986). The Effect of Palm Button Location on Hand Reach Speed for Power Press Operations. *Trends in Ergonomics/Human Factors III*, (Elsevier Science Publishers B.V. (North-Holland)).

ISO/TC 199 Safety of Machinery. (2008). ISO 13857:2008 - Safety of Machinery -- Safety Distances to Prevent Hazard Zones Being Reached by Upper and Lower Limbs. Retrieved August 20, 2017, from <https://www.iso.org/standard/39255.html>

ISO. ISO 13855:2010, Safety of machinery — Positioning of Safeguards With Respect to the Approach Speeds of Parts of the Human Body (2010). Retrieved from <https://www.iso.org/obp/ui/#iso:std:iso:13855:ed-2:v1:en>

Jensen, R. (1989). Safe Hand-Button Distance for Mechanical Power Press (Unpublished Dissertation). West Virginia University, Morgantown West Virginia.

Jensen, R. (2017). Two-Hand Actuator Placement for Power Press Operation: A Reexamination of After-Reach Speeds. In *International Conference on Applied Human Factors and Ergonomics* (pp. 218–224). Springer. Retrieved from https://link.springer.com/chapter/10.1007/978-3-319-60525-8_23

Jensen, R., & Pizatella, T. J. (1986). Critical Review of Studies to Support Safe-Distance Formulas for Power Press Actuation Mechanisms. *Trends in Ergonomics/Human Factors III*.

Jensen, R., & Sinkule, E. (1988). Press Operator Amputations: Is Risk Associated with Age and Gender? *Journal of Safety Research*, 19(3), 125–133.

Jensen, R., & Stobbe, T. (2016). Safe Distance for Machinery Actuators: Is After-Reach Speed a Constant? In *Advances in Safety Management and Human Factors* (pp. 321–331). Springer, Cham. https://doi.org/10.1007/978-3-319-41929-9_30

Jiang, B. C., Lio, A. Y. H., Suresh, N., & Cheng, O. S. H. (1991). An evaluation of machine guarding techniques for robot guarding. *Robotics and Autonomous Systems*, 7(4), 299–308. [https://doi.org/10.1016/0921-8890\(91\)90061-O](https://doi.org/10.1016/0921-8890(91)90061-O)

Katoh, Z., Fukuta, Y., Nakashima, Y., Takeuchi, Y., Takamatsu, M., & Yoshihara, S. (2001). A Study on Approach Speeds of the Hands Under Metal Press Machine Operation. In *Proceedings of the Human Factors and Ergonomics Society Annual Meeting* (Vol. 45, pp. 1119–1122). SAGE Publications Sage CA: Los Angeles, CA. Retrieved from <http://journals.sagepub.com/doi/abs/10.1177/154193120104501428>

Keyence. (2017). Light Curtain Installation and Safety Distance (Minimum Distance). Retrieved October 3, 2017, from <http://www.keyence.eu/ss/products/safetyknowledge/caution/>

Kim, S., & Nussbaum, M. A. (2013). Performance Evaluation of a Wearable Inertial Motion Capture System for Capturing Physical Exposure During Manual Material Handling. *Ergonomics*, 56.

- Lapinski, M., Berkson, E., Gill, T., Reinold, M., & Paradiso, J. A. (2009). A Distributed Wearable, Wireless Sensor System for Evaluating Professional Baseball Pitchers and Batters (pp. 131–138). IEEE. <https://doi.org/10.1109/ISWC.2009.27>
- Lebel, K., Boissy, P., Hamel, M., & Duval, C. (2013). Inertial Measures of Motion for Clinical Biomechanics: Comparative Assessment of Accuracy under Controlled Conditions - Effect of Velocity. *PLoS ONE*, *8*(11), e79945. <https://doi.org/10.1371/journal.pone.0079945>
- Lin, J.-F. (2009). A General Model That Accounts for Fitts' Law and Drury's Model. In *Proceedings of the 17th Congress of the International Ergonomics Association, Beijing, China*.
- Lobl, O. (1935). On The Two-Hand Insertion on Eccentric Presses-A Study of the Limits of the Protective Effect. *Reichsarbeitsblatt (Berlin)*, *20* (part 111).
- Luinge, H. J., Veltink, P. H., & Baten, C. T. M. (2007). Ambulatory Measurement of Arm Orientation. *Journal of Biomechanics*, *40*(1), 78–85. <https://doi.org/10.1016/j.jbiomech.2005.11.011>
- Marovich, J. (2015, June 12). Basic Metal Stamping Die Components and Terminology | TurboFuture. Retrieved August 27, 2017, from <https://turbofuture.com/industrial/Basic-Metal-Stamping-Die-Terminology>
- Marsh, S. M., & Fosbroke, D. E. (2015). Trends of occupational fatalities involving machines, United States, 1992–2010. *American Journal of Industrial Medicine*, *58*(11), 1160–1173. <https://doi.org/10.1002/ajim.22532>
- McCaffrey, D. P. (1981). Work-Related Amputations by Type and Prevalence. *Monthly Lab. Rev.*, *104*, 35.
- McLaughlin, P. (2013). Testing Agreement Between a New Method and the Gold Standard—How do we Test? *Journal of Biomechanics*, *46*(16), 2757–2760. <https://doi.org/10.1016/j.jbiomech.2013.08.015>
- Merriault, P., Dupuis, Y., Bouteau, R., Vasseur, P., & Savatier, X. (2017). A Study of Vicon System Positioning Performance. *Sensors*, *17*(7), 1591. <https://doi.org/10.3390/s17071591>
- Myles, P. S., & Cui, J. (2007). Using the Bland–Altman Method to Measure Agreement With Repeated Measures. *BJA: British Journal of Anaesthesia*, *99*(3), 309–311. <https://doi.org/10.1093/bja/aem214>
- NIOSH. (1987, March). CDC - NIOSH Publications and Products - Injuries and Amputations Resulting from Work with Mechanical Power Presses (87-107), Current Intelligence Bulletin 49 [Gov]. Retrieved August 9, 2017, from <https://www.cdc.gov/niosh/docs/87-107/default.html>

Oleske, D. M., & Hahn, J. J. (1992). Work-related injuries of the hand: data from an occupational injury/illness surveillance system. *Journal of Community Health, 17*(4), 205–219.

OSHA. (1987). Guidelines For Robotics Safety. OSHA.

OSHA. (1999). OSHA Technical Manual (OTM) | Section IV: Chapter 4 - Industrial Robots and Robot System Safety | Occupational Safety and Health Administration. Retrieved September 24, 2017, from https://www.osha.gov/dts/osta/otm/otm_iv/otm_iv_4.html

OSHA. (2007). Safeguarding Equipment and Protecting Employees from Amputations. OSHA. Retrieved from <http://www.cmafh.com/WebsiteCatalogs/VendorVideos/TechnicalDropDown/Safety/OSHAGuideSafeGuardingEquipment.pdf>

OSHA 1910.212. 1910.212-General Requirements for all Machines, Occupational Safety and Health Administration (1970). Retrieved from https://www.osha.gov/pls/oshaweb/owadisp.show_document?p_table=standards&p_id=9836

OSHA 1910.213. 1910.213- Woodworking Machinery Requirements, Occupational Safety and Health Administration (1984). Retrieved from https://www.osha.gov/pls/oshaweb/owadisp.show_document?p_table=STANDARDS&p_id=9837

OSHA 1910.215. 1910.215-Abrasive Wheel Machinery, Occupational Safety and Health Administration (1996). Retrieved from https://www.osha.gov/pls/oshaweb/owadisp.show_document?p_id=9839&p_table=STANDARDS

OSHA 1910.216. 1910.216-Mills and Calenders in the Rubber and Plastics Industries, Occupational Safety and Health Administration (1996). Retrieved from https://www.osha.gov/pls/oshaweb/owadisp.show_document?p_table=STANDARDS&p_id=9840

OSHA 1910.217. 1910.217- Machinery and Machine Guarding: Mechanical Power Presses (2013). Retrieved from https://www.osha.gov/pls/oshaweb/owadisp.show_document?p_table=STANDARDS&p_id=9841

OSHA 1910.218. 1910.218- Forging Machines, Occupational Safety and Health Administration (1996). Retrieved from https://www.osha.gov/pls/oshaweb/owadisp.show_document?p_table=STANDARDS&p_id=9846

OSHA 1910.219. 1910.219-Mechanical Power-Transmission Apparatus, Occupational Safety and Health Administration (2004). Retrieved from

https://www.osha.gov/pls/oshaweb/owadisp.show_document?p_id=9847&p_table=STANDARD
S

OSHA and Machine Guarding: Aging Standards. (2010, July 13). *Plant Engineering Magazine*. Retrieved from <http://www.plantengineering.com/single-article/osha-and-machine-guarding-aging-standards/2b948d8a12fa3343113751adbc15c82d.html>

OSHA Etool Website. (2017). 29 CFR 1910.217 Appendix I. Retrieved August 31, 2017, from https://www.osha.gov/SLTC/etools/machineguarding/appendices/appendix_i.html

Parker, D. L., Yamin, S. C., Brosseau, L. M., Xi, M., Gordon, R., Most, I. G., & Stanley, R. (2015). National Machine Guarding Program: Part 1. Machine Safeguarding Practices in Small Metal Fabrication Businesses. *American Journal of Industrial Medicine*, 58(11), 1174–1183. <https://doi.org/10.1002/ajim.22514>

Pizatella, T. J., Etherton, J. R., Jensen, R., & Oppold, J. A. (1983). Investigation of the After-reach Hazard in Two-Hand Controlled Power Press Operations. *Scandinavian Journal of Work, Environment & Health*, 9(2), 194–200. <https://doi.org/10.5271/sjweh.2426>

Pizatella, T. J., & Moll, M. B. (1987). Simulation of the After-Reach Hazard on Power Presses Using Dual Palm Button Actuation. *Human Factors*, 29(1), 9–18. <https://doi.org/10.1177/001872088702900102>

Potter, R. (1983). Requirements for Developing Safety in Robot Systems. *Industrial Engineering*, (June, 1983).

Powell, C. H., & Christensen, H. E. (1975). Development of Occupational Standards. *Archives of Environmental Health*, 30(4), 171.

Prasad, V. S. N., Kellokumpu, V., & Davis, L. S. (2006). Ballistic Hand Movements. In *Articulated Motion and Deformable Objects* (pp. 153–164). Springer, Berlin, Heidelberg. https://doi.org/10.1007/11789239_16

Robert-Lachaine, X., Mecheri, H., Larue, C., & Plamondon, A. (2017). Validation of Inertial Measurement Units with an Optoelectronic System for Whole-Body Motion Analysis. *Medical & Biological Engineering & Computing*, 55(4), 609–619. <https://doi.org/10.1007/s11517-016-1537-2>

Rockwell Automation. (2015). *ANSI/RIA R15.06 - An introduction to Robot and Robot System Safety*.

Roetenberg, D., Luinge, H., & Slycke, P. (2009). *Xsens MVN: Full 6DOF Human Motion Tracking Using Miniature Inertial Sensors* (Vol. 3).

- Saber-Sheikh, K., Bryant, E. C., Glazzard, C., Hamel, A., & Lee, R. Y. W. (2010). Feasibility of Using Inertial Sensors to Assess Human Movement. *Manual Therapy, 15*(1), 122–125. <https://doi.org/10.1016/j.math.2009.05.009>
- Schall Jr., M. C., Fethke, N. B., Chen, H., & Gerr, F. (2015). A Comparison of Instrumentation Methods to Estimate Thoracolumbar Motion in Field-Based Occupational Studies. *Applied Ergonomics, 48*, 224–231. <https://doi.org/10.1016/j.apergo.2014.12.005>
- Schall Jr., M. C., Fethke, N. B., Chen, H., Oyama, S., & Douphrate, D. I. (2016). Accuracy and Repeatability of an Inertial Measurement Unit System for Field-Based Occupational Studies. *Ergonomics, 59*(4), 591–602. <https://doi.org/10.1080/00140139.2015.1079335>
- SICK AG. (2014). Safety Guide for the Americas. SICK AG.
- SICK AG. (2017). SICK's Company History. Retrieved October 1, 2017, from <https://www.sick.com/us/en/about-sick/sicks-company-history/w/the-history-of-sick/>
- Stender, J. H. (1975). An OSHA Perspective and Prospective. *Labor Law Journal, 26*(2), 71.
- Strubhar, P. (1985). Robotic Safeguarding. *RIA Robot Safety Seminar Proceeds, 1985*.
- Suokas, J. (1983). The effect of power-press regulations in Finland. *Journal of Occupational Accidents, 5*(1), 1–8.
- Thomas Engineering Company. (2015, June 26). Metal Stamping History | Thomas Engineering Company. Retrieved August 27, 2017, from <http://www.thomasengineering.com/blog/a-brief-history-of-metal-stamping/>
- Vaillancourt, D. R., & Snook, S. H. (1995). A Review of Machine-Guarding Recommendations. *Applied Ergonomics, 26*(2), 141–145. [https://doi.org/10.1016/0003-6870\(95\)00011-Z](https://doi.org/10.1016/0003-6870(95)00011-Z)
- Welford, A. T. (1984). Between bodily changes and performance: Some possible reasons for slowing with age. *Experimental Aging Research, 10*(2), 73–88. <https://doi.org/10.1080/03610738408258548>
- Woodman, O. J. (2007). *An Introduction to Inertial Navigation* (No. Technical Report 696). University of Cambridge, Computer Laboratory.
- Xsens Technologies B.V. (2008). *MVN User Manual-4.3* (User Guide MVN, MVN BIOMECH MVN Link, MVN Awinda No. Document MV0319P (Rev Q)). Xsens Technologies B.V.
- Yamin, S. C., Bejan, A., Parker, D. L., Xi, M., & Brosseau, L. M. (2016). Analysis of Workers' Compensation Claims Data For Machine-Related Injuries in Metal Fabrication Businesses. *American Journal of Industrial Medicine, 59*, 656–664.

Yamin, S., Parker, D., Brosseau, L., Gordon, B., & Xi, M. (2014). National Machine Guarding Program: Design of a Machine Safety Intervention. *Safety Science Monitor (Sweden)*, 18(1). Retrieved from http://130.237.83.55/volumes/vol18/Issue1/5_Yamin.pdf

Zhou, H., & Hu, H. (2007). Inertial Sensors for Motion Detection of Human Upper Limbs. *Sensor Review*, 27(2), 151–158.

Zhou, H., Hu, H., & Tao, Y. (2006). Inertial Measurements of Upper Limb Motion. *Medical & Biological Engineering & Computing*, 44(6), 479–487. <https://doi.org/10.1007/s11517-006-0063-z>

Zhou, H., Stone, T., Hu, H., & Harris, N. (2008). Use of Multiple Wearable Inertial Sensors in Upper Limb Motion Tracking. *Medical Engineering & Physics*, 30(1), 123–133. <https://doi.org/10.1016/j.medengphy.2006.11.010>

Zou, G. (2013). Confidence Interval Estimation for the Bland–Altman Limits of Agreement with Multiple Observations Per Individual. *Statistical Methods in Medical Research*, 22(6), 630–642. <https://doi.org/10.1177/0962280211402548>

Appendices

Appendix 1: Process Flow Diagram for Hand Speed Experiment

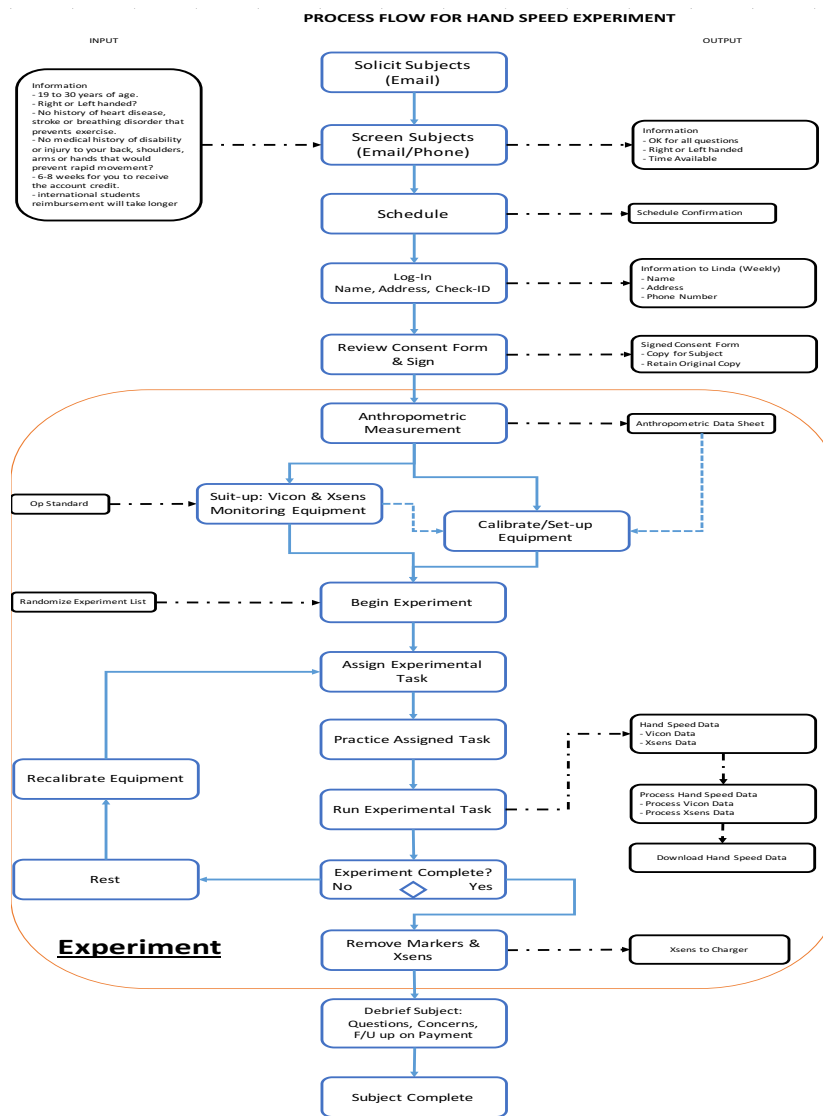

Appendix 2: Design of Experiment

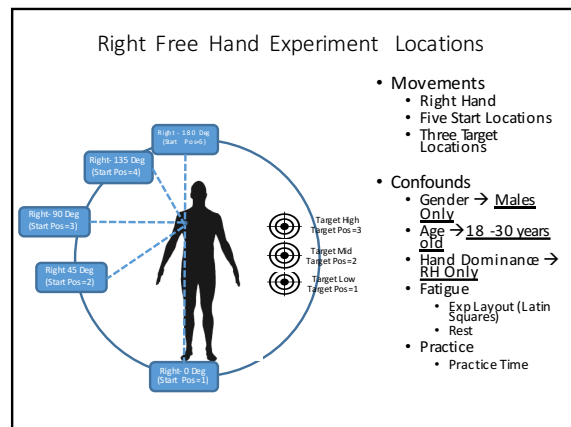
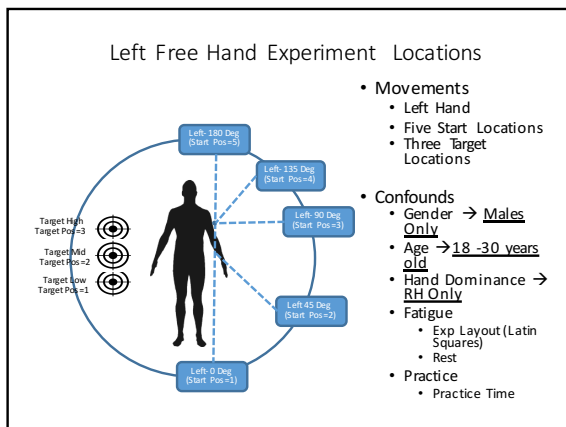
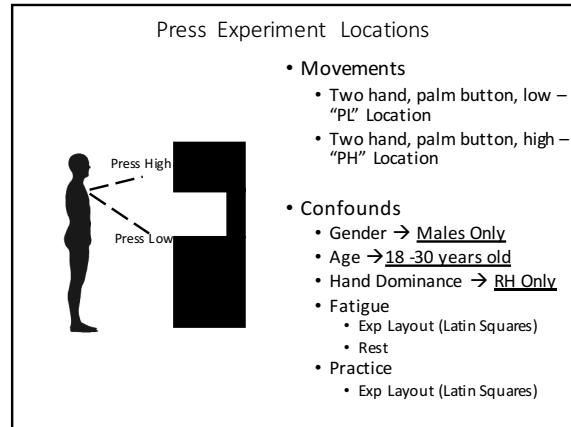
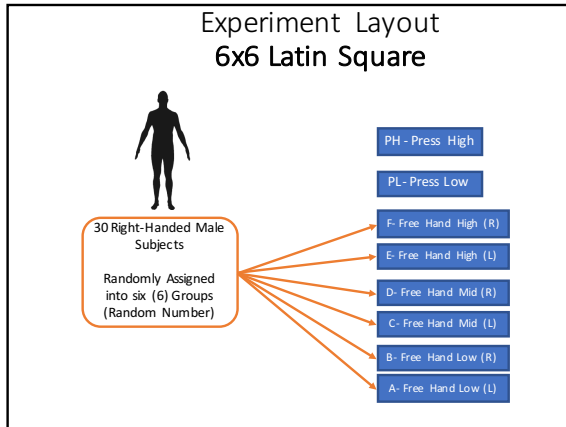

Appendix 3: Anthropometry Procedures for Hand Speed Study

Figures & Pictures Taken from 2012 Anthropometric Survey of the US Army, ADA611869

Measurement Criteria & Information From:

TECHNICAL REPORT
NATIC/TR-15-007



AD _____

2012 ANTHROPOMETRIC SURVEY OF U.S. ARMY PERSONNEL: METHODS AND SUMMARY STATISTICS

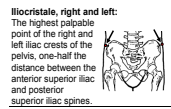
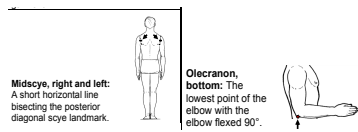
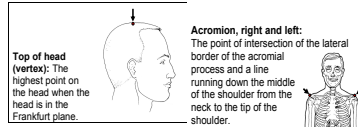

WEIGHT

(91) WEIGHT

The weight of the participant is taken to the nearest tenth of a kilogram. The participant stands on the platform of a scale with the weight distributed evenly on both feet.

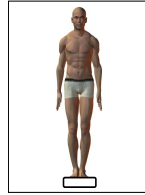

STATURE

(75) STATURE

The vertical distance from a standing surface to the top of the head is measured with an anthropometer. The participant stands erect with the head in the Frankfurt plane. The heels are together with the weight distributed equally on both feet. The shoulders and upper extremities are relaxed. The measurement is taken at the maximum point of quiet respiration.

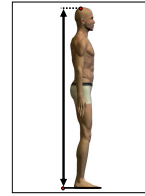

Page #1

EYE HEIGHT

(D16) EYE HEIGHT

The vertical distance between a standing surface and the ectocanthus landmark of a participant standing erect with the head in the Frankfurt plane is calculated as follows: EYE HEIGHT SITTING plus STATURE minus SITTING HEIGHT.

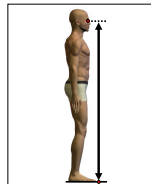

ARM SPAN

(74) SPAN

The distance between the tips of the middle fingers (dactylion III) of the horizontally outstretched arms is measured on a wall chart. The participant stands erect with the back against a wall-mounted scale and the heels together. Both arms and hands are stretched horizontally along the wall with the tip of the middle finger of one hand just touching a side wall. A block is placed at the tip of the middle finger of the other hand to establish the measurement on the scale. The measurement is taken at the maximum point of quiet respiration.

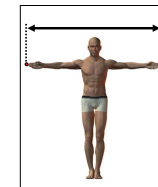

SHOULDER HEIGHT

(2) ACROMIAL HEIGHT

The vertical distance between a standing surface and the right acromion landmark is measured with an anthropometer. The participant stands erect, looking straight ahead. The heels are together with the weight distributed equally on both feet. The shoulders and upper extremities are relaxed. The measurement is taken at the maximum point of quiet respiration.

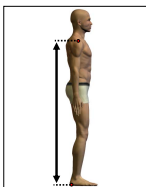

SHOULDER WIDTH

(55) INTERSCYE II

The distance across the back between the right and left midscye landmarks is measured with a tape. The tape is held on the skin surface except where it spans the hollow of the back. The participant stands erect, looking straight ahead. The heels are together with the weight distributed equally on both feet. The shoulders and upper extremities are relaxed. The measurement is taken at the maximum point of quiet respiration.



Page #2

ELBOW HEIGHT

(D14) ELBOW REST HEIGHT, STANDING

The vertical distance between a standing surface and the olecranon bottom landmark of a participant standing erect with the forearm and hand held horizontally is calculated as follows: ELBOW REST HEIGHT plus STATURE minus SITTING HEIGHT.

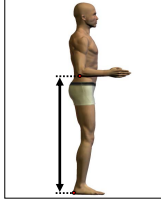

SHOULDER - ELBOW LENGTH

(69) SHOULDER-ELBOW LENGTH

The distance between the right acromion landmark and the olecranon bottom landmark is measured with a beam caliper parallel to the long axis of the upper arm. The participant stands with the right upper arm hanging at the side and the elbow flexed 90°. The hand is straight, and the palm faces inward.

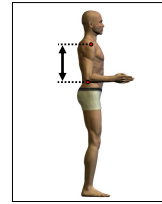
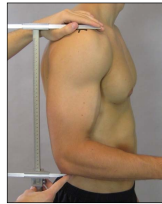

WRIKLE HEIGHT

(D38) VERTICAL THUMB TIP REACH, SITTING

The vertical distance between a sitting surface and the tip of the right thumb of a participant sitting erect with the right shoulder, arm, and hand held straight overhead with the thumb knig on the first knuckle of the index finger is calculated as follows: OVERHEAD FINGER TIP REACH SITTING minus ANSUR mean of HAND LENGTH plus ANSUR mean of WRIST-THUMB TIP LENGTH.

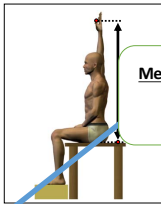

Measurement Canceled
Not Required for
Experiment

ELBOW-FINGER TIP LENGTH

(40) FOREARM-HAND LENGTH

The horizontal distance between the olecranon rear landmark and the dactyion III landmark is measured with a beam caliper. The participant stands erect with the upper arms hanging at the sides and the right elbow flexed 90°. The hand is held out straight with the palm facing inward.

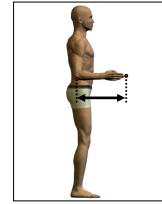

FINGER TIP HEIGHT

(D31) VERTICAL INDEX FINGERTIP REACH, SITTING

The vertical distance between a sitting surface and the tip of the right index finger of a participant sitting erect and raising the right shoulder, arm, and fingers straight overhead is calculated as follows: OVERHEAD FINGERTIP REACH SITTING minus ANSUR mean of HAND LENGTH plus ANSUR mean of WRIST-INDEX FINGER LENGTH.

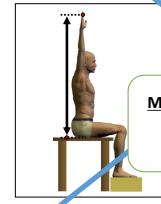

Measurement Canceled
Not Required for
Experiment

SHOULDER - FINGER TIP LENGTH

(D18) INDEX FINGER REACH

The horizontal distance between the vertical plane of the back and the tip of the right index finger of a participant standing erect with the back against a wall and the arm, hand, and fingers extended forward horizontally is calculated as follows: THUMB TIP REACH minus ANSUR mean of WRIST-THUMB TIP LENGTH plus ANSUR mean of WRIST-INDEX FINGER LENGTH.

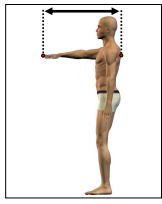

HIP HEIGHT

(52) ILLIOCRISTALE HEIGHT

The vertical distance between a standing surface and the right ilioicristale landmark is measured with an anthropometer. The participant stands erect with the heels together and the weight distributed equally on both feet. The shoulders and upper extremities are relaxed.

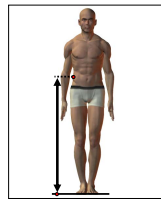
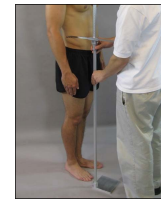

REACH

(D36) VERTICAL INDEX FINGERTIP REACH

The vertical distance between a standing surface and the tip of the right index finger of a participant standing erect with the right shoulder, arm, and fingers stretched straight overhead is calculated as follows: OVERHEAD FINGERTIP REACH SITTING plus (STATURE minus SITTING HEIGHT) minus (ANSUR mean of HAND LENGTH minus ANSUR mean of WRIST-INDEX FINGER LENGTH).

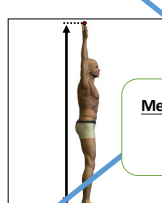

Measurement Canceled
Not Required for
Experiment

FINGER TIP HEIGHT

SHOULDER - FINGER TIP LENGTH
(D4) ARM LENGTH

The vertical distance between the acromion right landmark and the dactylion III landmark of a participant standing erect with the arms straight at the sides is calculated as follows: ACROMIAL HEIGHT minus WRIST HEIGHT plus HAND LENGTH.

**Measurement Canceled
Not Required for
Experiment**

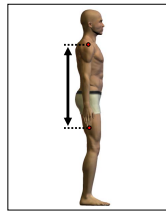

HIP HEIGHT

(52) ILIOCRISTALE HEIGHT

The vertical distance between a standing surface and the right ilioicristale landmark is measured with an anthropometer. The participant stands erect with the heels together and the weight distributed equally on both feet. The shoulders and upper extremities are relaxed.

REACH

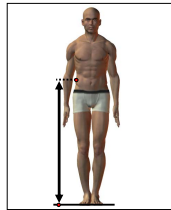
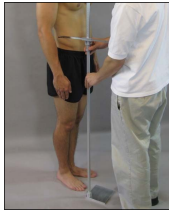

**Measurement Canceled
Not Required for
Experiment**

Page #5

HIP WIDTH

(50) HIP BREADTH

The horizontal distance between the lateral buttock landmarks is measured with a beam caliper. The participant stands erect with the heels together and the weight distributed equally on both feet.

FOOT SIZE

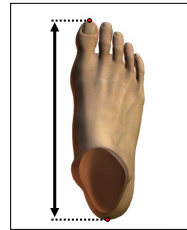
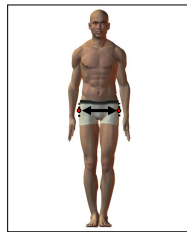

Page #6

Appendix 4: Procedures for Hand Speed Measurement Experiment

System Start-up (Prior to Participant Arrival)

- 1.0 Turn on the Desktop computer if not already on and log in.
- 2.0 Confirm the Vicon and Xsens licenses are plugged in the computer.
- 3.0 Place Xsens sensors in charging station.
- 4.0 Lay out the double-sided tape and Vicon sensors.
- 5.0 Lay out the MVN Awinda straps, two gloves, and the Xsens trackers.

Vicon Calibrate (Prior to Participant Arrival)

- 1.0 Turn on both Vicon system amplifiers (in the following order).
 - 1.1. Power-up the Upper Amp by pressing the power button on the front of the amp (power button “out”).
 - 1.2. Power-up Lower Amp by pressing the power button on the back of the amp (blue power light should display).
- 2.0 Open Vicon software (Vicon Nexus 1.85)
 - 2.1. Wait for all Cameras to come on-line; The IR emitters on all cameras should power up and glow red.
- 3.0 Mask Camera Volume
 - 3.1. Remove all reflective markers from work area (capture volume)
 - 3.1.1. Make sure that the calibration wand is not in the cameras’ field of view.
 - 3.2. Select all of the cameras you wish to use (1, 3, 4, 5, 6, 8, 11, 12).
 - 3.3. Switch to “Camera View.”
 - 3.4. Select ‘start’ on the Mask Cameras menu
 - 3.4.1. Let auto-mask program run for approximately 10 seconds.
 - 3.5. If there are any small unmasked, reflective areas (small white spots) after auto-mask has run, manually mask them.
 - 3.5.1. Zoom (right click and drag to the spot), selecting the “pen” button and clicking squares until the spot is masked.
 - 3.6. If there are any large unmasked areas, confirm there are no reflective materials in the white spots, repeat the Mask Camera process
 - 3.7. If the Masking is successful, select “stop”
- 4.0 Aim Cameras
 - 4.1. Remove the hand speed target from the free hand fixture and place fixture in the “calibration” position.
 - 4.2. Place the calibration wand on the free hand fixture.
 - 4.3. Confirm each camera can “see” the wand, by inspecting the camera display.
 - 4.4. If a camera cannot “see” the wand (and it is not paused), right click on “local Vicon system” and “reboot hardware.”
 - 4.5. Switch to 3D Perspective
 - 4.6. Select “start” under Aim Cameras, and let the Auto-Aim program run for approximately 5 seconds.
- 5.0 Confirm Camera Capture Volume
 - 5.1. Select “start” under Calibrate Cameras (making sure the Auto Stop box is checked). Move the calibration wand throughout the entire experimental area (area in which data will be collected) until all the cameras have a green light or the blue light has stopped

blinking (there are two versions of cameras so that is why there are two ways to tell if cameras have finished calibrating).

5.2. Wait for all the camera calibration feedback to load. Confirm the Image Error for each camera.

5.2.1. The image error for each camera should be less than or equal to 0.15 (less than or equal to 0.10 is an excellent calibration). Image errors that meet target should be displayed in green.

5.2.2. If any image error exceeds 0.25, repeat the Camera Capture Volume calibration process.

6.0 Set Camera View

6.1. Switch to 3D perspective. When the view is switched to 3D, one of the cameras will appear as the Vicon Origin

6.2. To select the calibration wand as the origin, select Set Volume Origin

6.3. After Calibration is Complete the calibration wand should appear as the Vicon Origin.

*Note: Vicon motion tracking system only needs to be calibrated before the first subject of the day or if the data collector has left the lab unsupervised for any prolonged length of time (i.e.: lunch break, to attend a meeting or class, etc.) in order to assure accurate data.

Informed Consent (Discussion with Subject)

1.0 Introduce yourself and explain the purpose of the research

1.1. See script in Appendix EX-1

2.0 Ask to see a picture identification & verify the subjects name.

3.0 Review the subject payment policy as follows:

3.1. "Payment for completing this experiment is \$30.00. This will be deposited to your bursar's account. Issuing the reimbursement will take 6-8 weeks."

3.2. "Payment for participating in this experiment will go to your bursar's account. If you receive financial aid the money will most likely be deducted from your account as part of your financial aid. You may not receive a cash benefit from this payment."

3.3. "Reimbursement for International Students is more difficult than US students and payment make take 10-12 weeks. In addition, international students may be required to pay income tax on this payment."

3.4. "Are you still interested in participating in this experiment?"

4.0 Ask the student to provide their full names (as shown on their Bursar's Account), student numbers, phone number and mailing address. Type this into the payment spreadsheet.

5.0 Provide the subject a copy of the informed consent document (Appendix Ex-2).

6.0 Review the informed consent point by point with the subject;

6.1. Answer any questions the subject may ask.

6.2. Ask the subject to sign the consent document.

6.3. Sign the informed consent document as the witness

6.4. Make a copy of the document and provide it to subject. Store the original document in a safe location.

Pre-Screening, Anthropometric Measurement, & Xsens & Vicon Suit-up

1.0 Pre-Screening

1.1. Confirm that the subject is “right-handed” (right hand dominate).

1.1.1. Left handed subjects will not be tested in this experiment.

1.2. Ask the Subject the screening questions (1-6) on the Screening & Anthropometry Data Sheet.

1.2.1. The subject must answer “no” on all questions to participate in the experiment.

2.0 Anthropometric Measurement

2.1. Using the anthropometric tool set gather the following data (see the Anthropometric Measurement) and enter it on the Screening & Anthropometry Data Sheet:

2.1.1. Age

2.1.2. Gender

2.1.3. Weight (kg)

2.1.4. Stature (cm)

2.1.5. Eye Height (cm)

2.1.6. Shoulder Height (cm)

2.1.7. Elbow Height (cm)

2.1.8. Hip Height (cm)

2.1.9. Hip Width (cm)

2.1.10. Arm Span (cm)

2.1.11. Shoulder Width (cm)

2.1.12. Shoulder to Elbow Length (cm)

2.1.13. Elbow to Finger Tip Length (cm)

2.1.14. Shoulder to Finger Tip Length (cm)

2.1.15. Foot Size (Heel to Toe) (cm)

3.0 Xsens Suit-up

3.1. Suit-up the subjects using MVN Awinda straps, hand band, and gloves for their Xsens motion trackers.

3.1.1. See Appendix EX-3 Xsens Layout.

3.2. Place all of the Xsens trackers in the corresponding pocket or in a central location (on the strap).

3.2.1. See Appendix EX-3 Xsens Layout.

3.2.2. The tracker should be in an orientation in which the “top” is facing upwards.

4.0 Vicon Suit-up

4.1. Place the Vicon markers on the subject using double-sided tape.

4.2. The markers will be placed per Appendix Ex-4 Vicon Layout.

Calibrate Xsens

1.0 Open MVN Studio

2.0 Start a new session on MVN Studio

3.0 Ensure that “Calibrate” icon is active in the workflow tool bar.

4.0 On the Body Dimensions tab, enter the subject’s anthropometric measurements from Screening & Anthropometry Data Sheet for the subject

5.0 Click the “Calibration” tab.

6.0 Have the subject put their hands by their sides and stand straight and still (see Xsens instructions below):

8.2.2 N-Pose (Neutral pose)

The N-Pose calibration is a basic calibration. It can be performed as a stand-alone calibration or before the hand-touch. When performing the calibration, take care of the following:

- Stand upright on a horizontal surface
- Feet parallel, one foot width apart.
- Knees above feet.
- Hips above knees.
- Back straight.
- Shoulders above hips; do not pull the shoulders up.
- Arm straight alongside body (vertically), thumbs forwards. Check the correct attitude of the arms by flexing and extending the elbows. The forearms should move only in the vertical (sagittal) plane with the palms of the hands facing each other.
- Face forward.
- Do not move during the calibration procedure.



Figure 35: N-Pose

Following the calibration, if the legs of the 3D character are crossed, when the feet are together then the feet were too far apart during the calibration. Repeat the calibration procedure with the feet closer together for an improved result.

Information/Figure Taken from “MVN User Manual-4.3”

7.0 Select N-pose and follow the instructions to perform a sensor to segment calibration.

8.0 Pay attention to the calibration quality displayed in the Messages for calibration window before applying the calibration to the character.

***Note:** Xsens 3D Motion Tracking System must be calibrated for each subject.

Entering Vicon Data

- 1.0 Switch tabs to the “Clapperboard” icon
- 2.0 Select a session
- 3.0 Make sure your data is saved in the right folder _____
- 4.0 Start Trial

Press Hand Speed Trials

- 1.0 Explain the experiment to the subject using the “Pre-Experiment Script.”
- 2.0 Review the following with the Subject
 - 2.1. If you change your mind about participating, you can withdraw from the experiment at any time. Your participation is completely voluntary.
 - 2.2. You will be allowed to practice the movement before executing the “high speed” motion.
 - 2.3. Throughout the tests, you be asked if you are experiencing any discomfort or fatigue. If you experience discomfort, the testing will be suspended. If you experience fatigue, you will be allowed to rest.
- 3.0 Explain the movement the Subject will be making (based on the randomized experiment schedule).
- 4.0 Allow the Subject to practice the required hand speed movement for 60 seconds.
- 5.0 Prep Vicon Data Collection
 - 5.1. Switch tabs to the “Clapperboard” icon
 - 5.2. Select a session
 - 5.3. Make sure your data is saved in the correct trial folder _____
- 6.0 Prep Xsens Data Collection

- 6.1. Switch tabs to the Collect Data Tab
- 6.2. Enter Session Name On Data Line
- 7.0 Ask the Subject to place his/her hands at the start positions.
- 8.0 Ask:” Are You Ready?”
- 9.0 Trigger data collection start on Xsens; Trigger data collection start on the Vicon.
- 10.0 Instruct the subject to make the hand speed motion as rapidly as possible three (3) times.
 - 10.1. “One, Two, Three, Go!” “One, Two, Three, Go!” “One, Two, Three, Go!”
- 11.0 Stop data collection on Xsens; Stop data collection on the Vicon.
- 12.0 Update the Xsens file name and save the file.
- 13.0 Allow the subject to rest 60 seconds.
- 14.0 Move to the next trial. Repeat process until all trials have been completed.

Free Hand Speed Trials

- 1.0 Explain the experiment to the subject using the “Pre-Experiment Script.”
- 2.0 Explain the movement the Subject will be making (based on the randomized experiment schedule).
- 3.0 Set hand speed start position.
- 4.0 Allow the Subject to practice the required hand speed movement for 60 seconds.
- 5.0 Prep Vicon Data Collection
 - 5.1. Switch tabs to the “Clapperboard” icon
 - 5.2. Select a session
 - 5.3. Make sure your data is saved in the correct trial folder _____
- 6.0 Prep Xsens Data Collection
 - 6.1. Switch tabs to the Collect Data Tab
 - 6.2. Enter Session Name On Data Line
- 7.0 Ask the Subject to place his/her hands at the start positions.
- 8.0 Ask:” Are You Ready?”
- 9.0 Trigger data collection start on Xsens; Trigger data collection start on the Vicon.
- 10.0 Instruct the subject to make the hand speed motion as rapidly as possible three (3) times.
 - 10.1. “One, Two, Three, Go!” “One, Two, Three, Go!” “One, Two, Three, Go!”
- 11.0 Stop data collection on Xsens; Stop data collection on the Vicon.
- 12.0 Update the Xsens file name and save the file.
- 13.0 Allow the subject to rest 60 seconds.
- 14.0 Move to the next trial. Repeat process until all trials have been completed.

Participant Check Out:

- 1.0 Remove all equipment from the subject and return the equipment to its correct storage location.
 - 1.1. Place all the Xsens IMU in the charging base for recharge.
- 2.0 Ask the subject has any follow-up questions or concerns.
 - 2.1. Make sure the subject has their copy of the Informed Consent Form.
- 3.0 Remind the subject that issuing the reimbursement will take 6-8 weeks; Thank them for their time.

Appendix 5: Layout for Xsens & Vicon Sensors

Silhouette Images Taken from: <http://clipart-library.com>

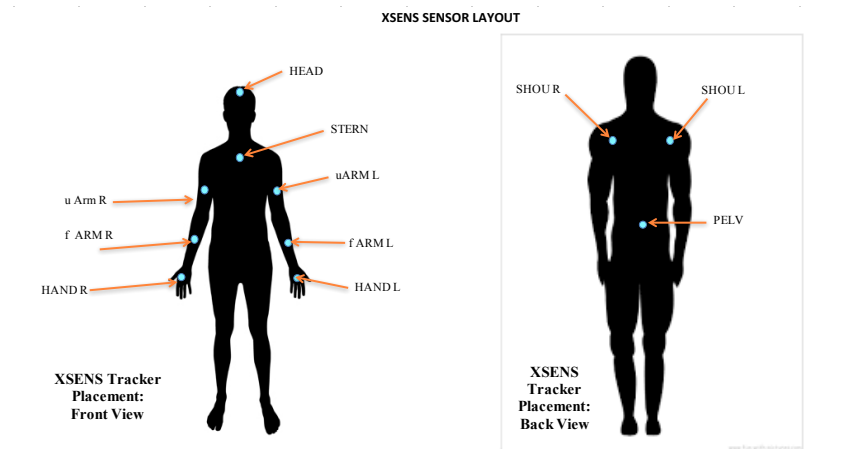

Appendix 6: Screening and Anthropometry Data Form

Subject Code: _____

Screening Questions:	Yes	No
1) Has your Doctor ever said that you have a heart condition or breathing disorder that prevents exercise or restricts your physical activity?		
2) Do you feel pain in your chest when you engage in physical activity?		
3) In the past month, have you had chest pains or shortness of breath when you were not doing physical activity?		
4) Do you have a medical history, disability, or injury to your back, shoulders, arms or hands?		
5) Do you have a bone, joint, or muscle condition that can be made worse by physical activity?		
6) Do you know of any reason why you should not engage in physical activity?		

General Information		
Age:		
Gender:		
Weight:		kg
Stature:		cm

Anthropometry Data	cm		cm
Eye Height		Arm Span	
Shoulder Height		Shoulder Width	
Elbow Height		Shoulder- Elbow Length	
Knuckle Height		Elbow- Finger Tip Length	
Finger Tip Height		Shoulder- Finger Tip Length	
Hip Height		Reach (over-head)	
Hip Width		Foot Size (Heal to Toe)	

Appendix 7: Informed Consent Form



INFORMED CONSENT For a Research Study Entitled: "Hand Speed and OSHA Machine Guarding"

Feb. 14, 2017

(NOTE: DO NOT SIGN THIS DOCUMENT UNLESS AN IRB APPROVAL STAMP WITH CURRENT DATES HAS BEEN APPLIED TO THIS DOCUMENT.)

You are invited to participate in a research study to develop a better understanding of the maximum hand speed in automated systems. The study is being conducted by Richard Garnett under the direction of Dr. Jerry Davis, Associate Professor in the Auburn University Department of Industrial and Systems Engineering.

You are qualified for this study if you have a valid driver's license and meet the following conditions:

- a) You are 19 to 30 years old
- b) You have no history of heart disease, stroke or breathing disorder that prevents exercise.
- c) You have no medical history, disability, or injury to your back, shoulders, arms or hands that would prevent rapid movement.

What will be involved if you participate?

- 1) On the day of the experiment, a researcher will meet with you, and review the experimental procedure and the consent form.
- 2) You will have to read and sign this informed consent form to participate in the experiment.
- 3) You will present your driver's license, Auburn ID or other photo ID to verify your ID.
- 4) You will have measurements taken of your height and weight, as well as measurements of other body dimensions such as lengths and circumferences of the arms, legs, etc. You will be asked screening questions to make sure it is safe for you to participate.
- 5) You will put on a wireless motion analysis system that will track your movement as you move your dominate hand/arm. Several matchbook-sized motion trackers will be strapped around various body segments (arms, hands, etc.). In addition, you will wear a few reflective markers for another motion analysis system. Markers will be placed on the shoulder, elbow, wrist, and hand of your dominate hand.
- 6) Once the motion analysis systems have been calibrated, you will be asked to make rapid hand movements from a fixed start position to a target position. You will be able to practice the movement several times before the actual measurement is taken.
- 7) After completing a trial, the Researchers will adjust the start position and target fixtures to the next trial position and the test will be repeated.
- 8) Throughout the tests the Researcher will ask you if you are experiencing any discomfort or fatigue. If you experiences discomfort, the testing will be suspended. If you experience fatigue, you will be allowed to rest.
- 9) After completing all trials, the instrumentation will be removed and you will be released.
- 10) The entire experiment should take 1.5 hours.

SHELBY CENTER FOR
ENGINEERING TECHNOLOGY
SUITE 3301
AUBURN, AL 36849-5346

TELEPHONE
334-844-4340

FAX:
334-844-1381

www.auburn.edu

INFORMED CONSENT
For a Research Study Entitled: "Hand Speed and OSHA Machine Guarding"

Are there any risks or discomforts?

The risks associated with this study are expected to be extremely minor, but may include the risk of pulled or sprained muscles from rapid hand movements. You will be allowed to practice the movement before executing the "high speed" motion. This "warm-up" should reduce the risk of muscle injury.

Are there any benefits to yourself or others?

Your participation will provide the researchers a greater understanding of the limits of hand speed and provide valuable information that can be used to design guarding for robotic & automated machinery.

Will you receive compensation for participating?

If you complete the study, you will receive \$30 compensation for your participation. The study should take approximately 1.5 hrs to complete.

Are there any costs?

If you decide to participate, you will not incur any costs.

Can I change my mind?

If you change your mind about participating, you can withdraw from the experiment at any time. Your participation is completely voluntary. If you choose to withdraw, your data will be withdrawn as long as it is identifiable. Your decision to participate or to stop participating will not jeopardize your future relations with Auburn University, the Samuel Ginn College of Engineering, or the Department of Industrial and Systems Engineering.

Please note! Should the experimental protocol result in a situation requiring significant medical attention, the investigators will summon emergency personnel if necessary. The researchers have no provisions for payment for any medical costs incurred as a result of participation in this study

Your privacy will be protected. Any information obtained in connection with this study will remain confidential. At the end of the study all links to identifiable information will be destroyed. Information obtained through your participation may be published in a professional journal and/ or presented at a professional meeting.

If you have questions about this study, please ask them now or contact Richard Garnett (rfg0004@tigermail.auburn.edu) or Associate Professor Jerry Davis at (334) 844-1424 or (davisga@auburn.edu).

INFORMED CONSENT
For a Research Study Entitled: "Hand Speed and OSHA Machine Guarding"

If you have questions about your rights as a research participant, you may contact the Auburn University Office of Human Subjects Research or the Institutional Review Board by phone (334)-844-5966 or e-mail at hsubjec@aubum.edu or IRBChair@aubum.edu.

A copy of this document will be given to you to keep

HAVING READ THE INFORMATION PROVIDED, YOU MUST DECIDE WHETHER OR NOT YOU WISH TO PARTICIPATE IN THIS RESEARCH STUDY. YOUR SIGNATURE INDICATES YOUR WILLINGNESS TO PARTICIPATE.

Participant's Signature

Date

Participant's Printed Name

Investigator Obtaining Consent Signature

Date

Investigator Obtaining Consent Printed Name